

MAIN CATALOG

PLC Automation

PLCs, Control Panels, Engineering Suite
AC500, CP600, Automation Builder



PLC Automation

PLCs, Control Panels, Engineering Suite

002–047 **PLC Automation product family**

048–061 **Automation Builder
Integrated engineering suite**

062–079 **AC500-eCo
Entry level PLC solutions**

080–129 **AC500
High performance modular PLC**

130–173 **AC500-XC
PLC operating in eXtreme
Conditions**

174–187 **AC500-S
Functional Safety PLC**

188–199 **CP600-eCo, CP600 and
CP600-Pro Control panels**

200–255 **Application descriptions and
additional information**

256–259 **Index**

PLC Automation product family

Overview

ABB offers a comprehensive range of scalable PLCs and robust HMI control panels. Since its launch, the AC500 PLC platform has achieved significant industry recognition for delivering high performance, quality and reliability.

Comprehensive range

- ABB delivers scalable, flexible and efficient ranges of automation components to fulfill all conceivable requirements of the most diverse automation applications.
- ABB's automation devices deliver solutions with high performance and flexibility to be effectively deployed within various industries and applications including water, building infrastructure, data centers, renewable energy, machinery automation, material handling, marine and many more.

Engineering suite

- ABB Automation Builder is the integrated software suite for machine builders and system integrators requiring state-of-the-art productive machine and system automation.
- Combining the tools required for configuring, programming, debugging and maintaining automation projects from one common intuitive interface, Automation Builder addresses the largest single cost element of most of today's industrial automation projects - software.

Programmable Logic Controllers PLCs

- The AC500-eCo, AC500, AC500-XC and AC500-S scalable PLC ranges provide solutions for small, medium and high-end applications.
- Our AC500 PLC platform offers different performance levels and is the ideal choice for high availability, extreme environments, condition monitoring, motion control or safety solutions.
- Our AC500 PLC platform offers interoperability and compatibility in hardware and software from compact PLCs up to high end and safety PLCs.

Control panels

- CP600-eCo, CP600 2nd generation and CP600-Pro control panels offer a wide range of features and functionalities for maximum operability.
- ABB control panels are distinguished by their robustness and easy usability, providing all the relevant information from production plants and machines at one single touch.

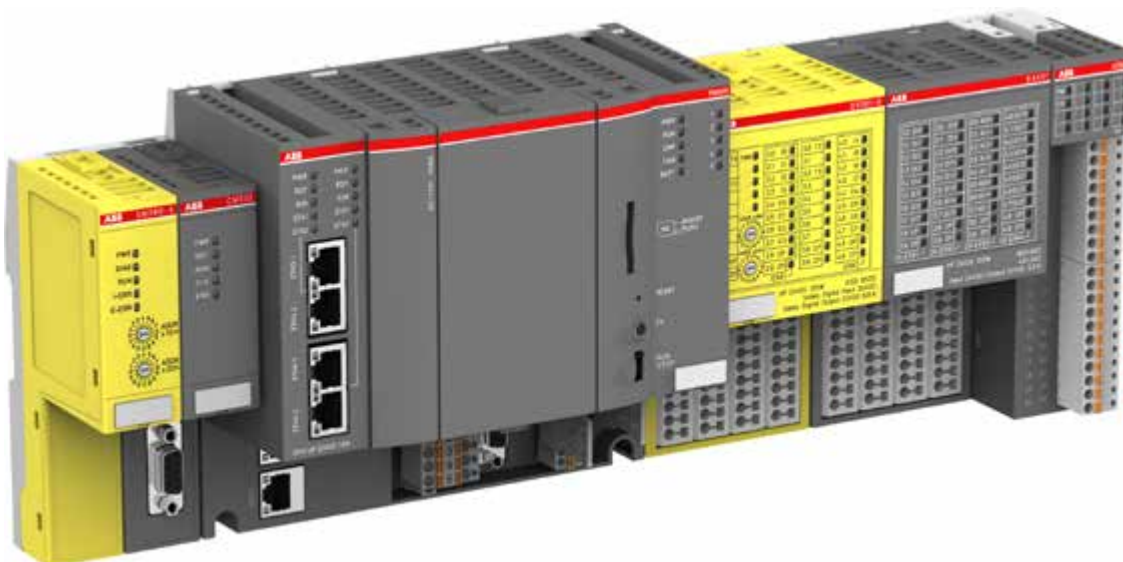

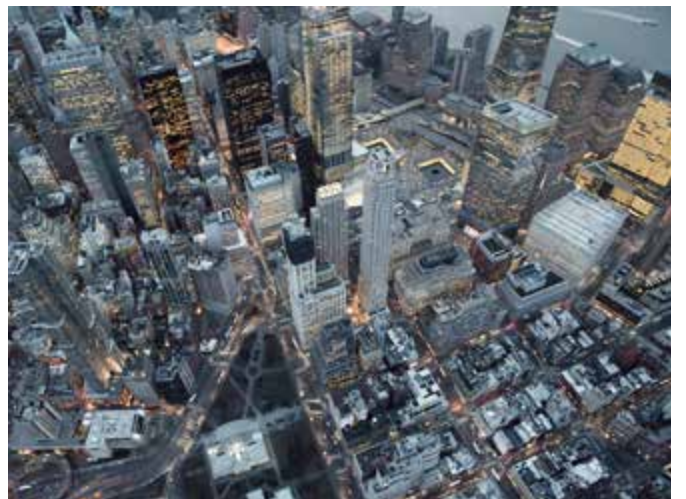

PLC Automation product family

Overview

Engineering suite



Automation Builder

- Automation Builder connects the engineering tools for PLC, safety, control panels, SCADA, drives and motion.
- Automation Builder combines the tools required for configuring, programming, debugging and maintaining automation projects from one common intuitive interface.



Library packages

- For efficient engineering of demanding applications.
- Easy-to-use application examples.

Visualization



CP600-eCo

- The economical CP600-eCo control panel is aimed for standard functions and high usability for clear interaction with the operation process.

Programmable Logic Controllers PLCs



AC500-eCo

- Compact PLC offering optimally suited flexible and economical configurations for automation solutions in smaller applications.
- ABB's AC500-eCo has been designed to integrate seamlessly into the broader AC500 PLC platform.

I/O modules



S500-eCo

- Range of modular I/Os for economical configurations in smaller applications.
- The I/O modules can be connected directly to the AC500 or AC500-eCo CPU modules.
- S500-eCo I/O modules can be mixed with standard S500 modules and also used as remote I/O with fieldbus communication interface modules.



CP600 2nd generation

- The robust CP600 2nd generation HMI provides high visualization performance, versatile communication and representative design for machines and systems.



CP600-Pro

- The CP600-Pro HMI portfolio comes with high end visualization performance, multi-touch operation, versatile trendsetting communication and representative design.



CP600-Pro

- Control panels CP6607...CP6615 can be used to alter functional safety control functions in industrial applications.



AC500

- Powerful PLC featuring a wide range of performance, communications and I/O capabilities for industrial applications.
- The ideal choice for complex, high-speed machinery and networking solutions.



AC500-XC

- Extreme condition PLC variant of the AC500 platform.
- With extended operating temperature, immunity to vibration and hazardous gases, use at high altitudes and in humid environments.



AC500-S

- Integrated safety PLC (SIL3, PL e) designed for safety applications involved in factory, machinery or process automation area.
- For simple and complex safety solutions.



S500

- Modular I/O assortment with protected outputs and comprehensive diagnosis, covering a wide range of signal types.
- The I/O modules can be installed as remote I/O with a communication interface module or be directly connected to the AC500 CPU.
- Support of different fieldbuses makes it possible to use the S500 I/O modules with PLCs from different manufacturers.



S500-XC

- Extreme condition variant of the S500 I/O system.
- With extended operating temperature, immunity to vibration and hazardous gases, use at high altitudes and in humid environments.



S500-S

- Safety variant of the S500 I/O system.
- Extreme condition variants available.

PLC Automation product family

Connectivity

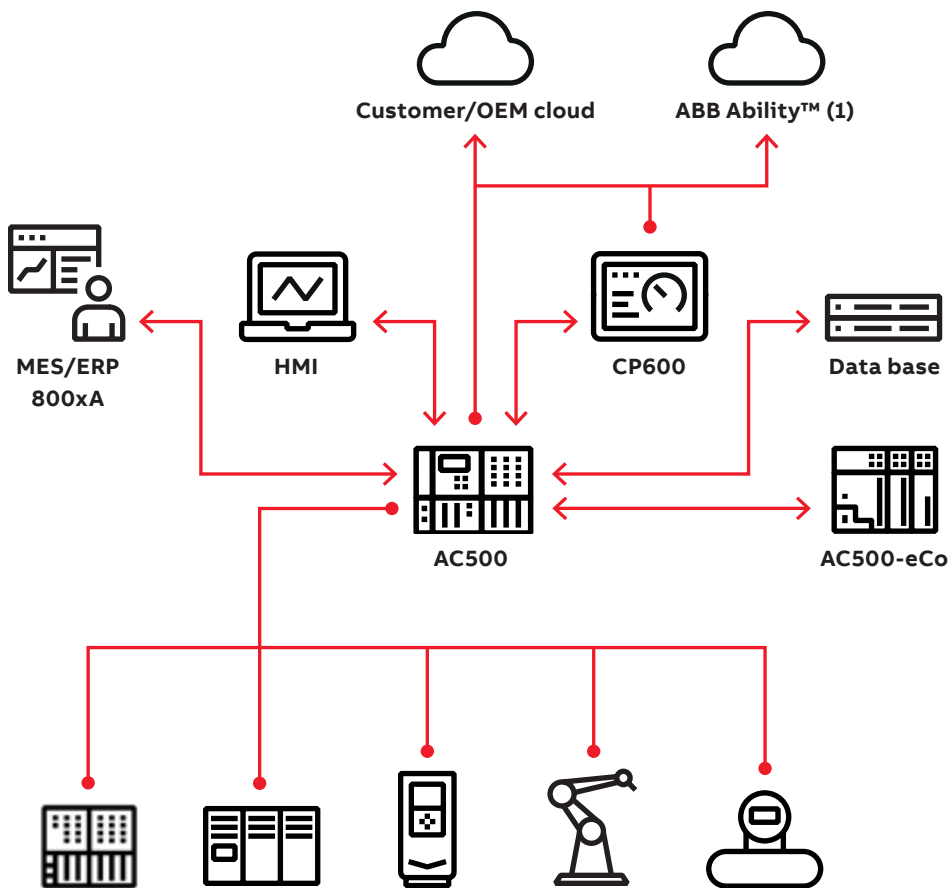

(1) In preparation

IT network/internet

- MQTT
- OPC UA
- HTTP(S)
- FTP(S)
- SNTP

Factory/site network

- OPC DA/AE
- OPC UA
- UDP
- TCP/IP
- KNX
- BACnet
- MySQL / MSSQL
- HTTP(S)
- FTP(S)
- SNTP
- SNMP

Control network

- PROFINET
- EtherCAT
- Modbus TCP
- Modbus RTU
- PROFIBUS DP
- IEC 60870-5-104
- IEC 61850
- CANopen

Protocol	Application example
OPC UA	SCADA and cloud connectivity: Give access to selected AC500 variables and objects
MQTT	Certificated based publishing of data to private clouds for dashboards or data analytics
HTTP(S)	Publish HTML5 websites for monitoring and control
HTTP Request	Request information like temperature, humidity etc. from devices with web server functionality
Connector to SQL Database	Save to or get data from MSSQL or MySQL databases
SNMP Agent	Send traps (up to 4096 process alarms per PLC) to a SNMP management tool
SNMP Manager	Act as a SNMP Manager with Set and Get commands
BACnet	Give access to selected AC500 variables and objects
UDP and TCP/IP	Implement specific and efficient own communications
FTP(S)	Server and client for secure and efficient exchange of big data

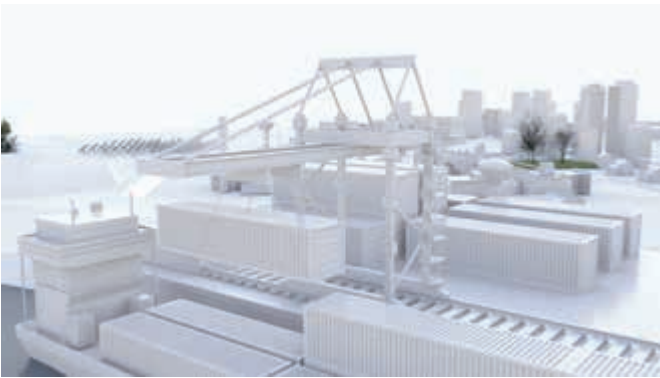

PLC Automation product family

Automation Builder

Engineering productivity for machine builders and system integrators.



Product license options

	Automation Builder Basic	Automation Builder Standard	Automation Builder Premium
Free	●		
AC500-eCo	●	●	●
AC500 with local I/O & network (1)	●	●	●
AC500 with fieldbus (2)		●	●
AC500-S Safety		○	○
Drive Manager		●	●
Drive application programming (3)	●	●	●
Motion programming	● (4)	●	●
Panel Builder 600	○	●	●
Panel Builder 600 Basic	●	●	●
Integrated engineering (5)		●	●
Productivity features (6)			●
Additional features (7)		○	○

- fully
- partly

(1) TCP protocols, Modbus, IEC60870-5-104, CS31

(2) PROFIBUS, PROFINET, EtherCAT, CAN

(3) Drive application programming for drives with embedded PLC (only available with Automation Builder 2.1 and before). Drive Composer pro license included in Standard and Premium Edition.

(4) No Fieldbus connectivity in Automation Builder Basic

(5) PLC, Safety, Panel, Drive, Motion, SCADA

(6) C/C++, ECAD data exchange, CSV interface extensions, project compare, project scripting

(7) Virtual Commissioning Platform for virtual system testing, Professional Developer Tools e.g. for multi-user engineering or static code analysis



Discover engineering productivity when designing your automation solutions

Automation Builder is ABB's integrated programming, simulation, commissioning and maintenance environment for PLCs, safety, drives, motion, control panels and SCADA. Automation Builder combines the proven ABB tools Drive Manager, Drive composer pro, Mint WorkBench, Panel Builder and ABB zenon.

Always get the right scope of Automation Builder for your automation solutions

One single software installer helps you to create and maintain your personal Automation Builder configuration - either on your PC or on a server. Any changes or updates are just a matter of a few mouse clicks. The Automation Builder licensing system is designed for supporting most operation scenarios. Licenses can be installed on PCs, USB dongles or license servers. In case of changes in the organization or in the engineering workflows the licenses can easily be transferred to where you need them.

Next level engineering efficiency

Improve your engineering efficiency by maximizing data re-use. Data that is available from third party tools can be imported or synchronized, either via dedicated interfaces or generic Excel sheets. Configurations that have been created for the PLC can automatically be re-used e.g. for the configuration of drives or operator panels.

Engineering efforts can be reduced further by using easy-to-use libraries e.g. for wind, water, solar, drives, motion, robotics, safety and building automation applications. And in case building blocks are missing for your automation solution simply create them yourself. Project scripting allows you to automate the creation of any part of your configuration or application.

PLC Automation product family

Automation Builder

Minimized efforts for project code and data administration

Configure and program all devices of your automation solution in one single project. This makes it easy to share your solutions with others. For more advanced usage the integrated version control system supports further scenarios like multi-user engineering or product line management.

Managing the life-cycle of your automation solutions is also easy. The annual Automation Builder release also supplies you with the latest versions of device firmware. The decision, whether to use the latest firmware with the latest feature set or to keep the current firmware with the current feature set can be made for each project and independent of the installed Automation Builder version.

Speeding up during commissioning and maintenance

Whenever there is an issue in the automation system, it is required to quickly and efficiently fix it. Automation Builder supports this by a generic three-step approach:

- General diagnosis provides a traffic light view on devices and (sub)systems.
- Detailed diagnosis provides detailed information e.g. about the source and the type of the issue.
- Extended diagnosis is available for some subsystems such as fieldbuses and offers advanced commissioning functions such as comparing connected vs. configured devices or manual control of bus states.

The diagnosis information is accessible not only via Automation Builder, but also via the AC500 display, the PLC application or operator panels.

Easily create a connected world

To achieve advanced connectivity, the ABB zenon software has been added to Automation Builder. The advantage of the ABB zenon software is that it provides high quality documentation for easy traceability and high transparency of automation system states as required in machine building or in infrastructure projects. It incorporates an energy data management system and comprehensive security features to unlock the potential of the Internet of Things.

Advanced simulation – a game changer in engineering

Simulate all kinds of applications with minimum effort. Test the complete system seamlessly before involving real hardware. Even complex systems can be built up efficiently, ensuring smooth interaction of all components and operator training at an early stage.



Download Automation Builder from
www.abb.com/automationbuilder
Familiarize yourself with Automation Builder
using the 30-day test license.

PLC Automation product family

AC500 libraries and software

A good investment for system integrators and end-users, AC500 libraries and software improve stability while reducing warranty costs and service. Library and software packages contain functions or protocols and easy-to-use examples for minimal programming effort and quick implementation of complex and demanding applications.

AC500 libraries and software deliver the seamless integration of PLCs, drives and HMI required to build and commission automation solutions quickly and easily. AC500 libraries and software by ABB are maintained to ensure that your programs can also be used with less risk.





Solar library

Library package for solar trackers increasing energy efficiency, providing quick commissioning and excellent positioning accuracy.

Water library

Library package with energy efficiency functionalities offering quick commissioning of water applications, such as pump stations with remote communication.

Temperature control library

Library package for the advanced PID temperature control of demanding applications, for example extrusion.

HA-CS31 library

Library package adds high availability system functionality for redundant hot standby over serial CS-31 bus.

Drive integration library

Library package for the quick integration of ABB ACS drives using different fieldbusses.

Motion control library

Library package for decentral, central and coordinated motion according to the PLCopen standard.

BACnet library

Library package adds BACnet-ASC device profile for communication to BMS Building Management Systems in larger infrastructure projects.

HA-Modbus TCP library

Library package adds High Availability System functionality for redundant hot standby over Ethernet field network via Modbus TCP.

KNX protocol

Engineering and protocol package which seamlessly integrates ETS and Automation Builder.

61850 protocol

Adds engineering tool and library for 61850 Ed.1 MMS Server and GOOSE publish and subscribe functionalities.

PCO library

Contains process control function blocks for integration of AC500 as controller in a DCS solution. For ABB Ability™ System 800xA an object library is available which provides matching symbols and faceplates.

PLC Automation product family

PLCs at a glance...

AC500 Programmable Logic Controllers with scalable, state-of-the-art technology for better performance.

Standard industrial communication fieldbus, network and protocols supported by the 'One Platform' solution make the AC500 the perfect automation solution in even the most demanding

environments. Flexible and scalable superior CPUs deliver performance whenever and wherever you need it.



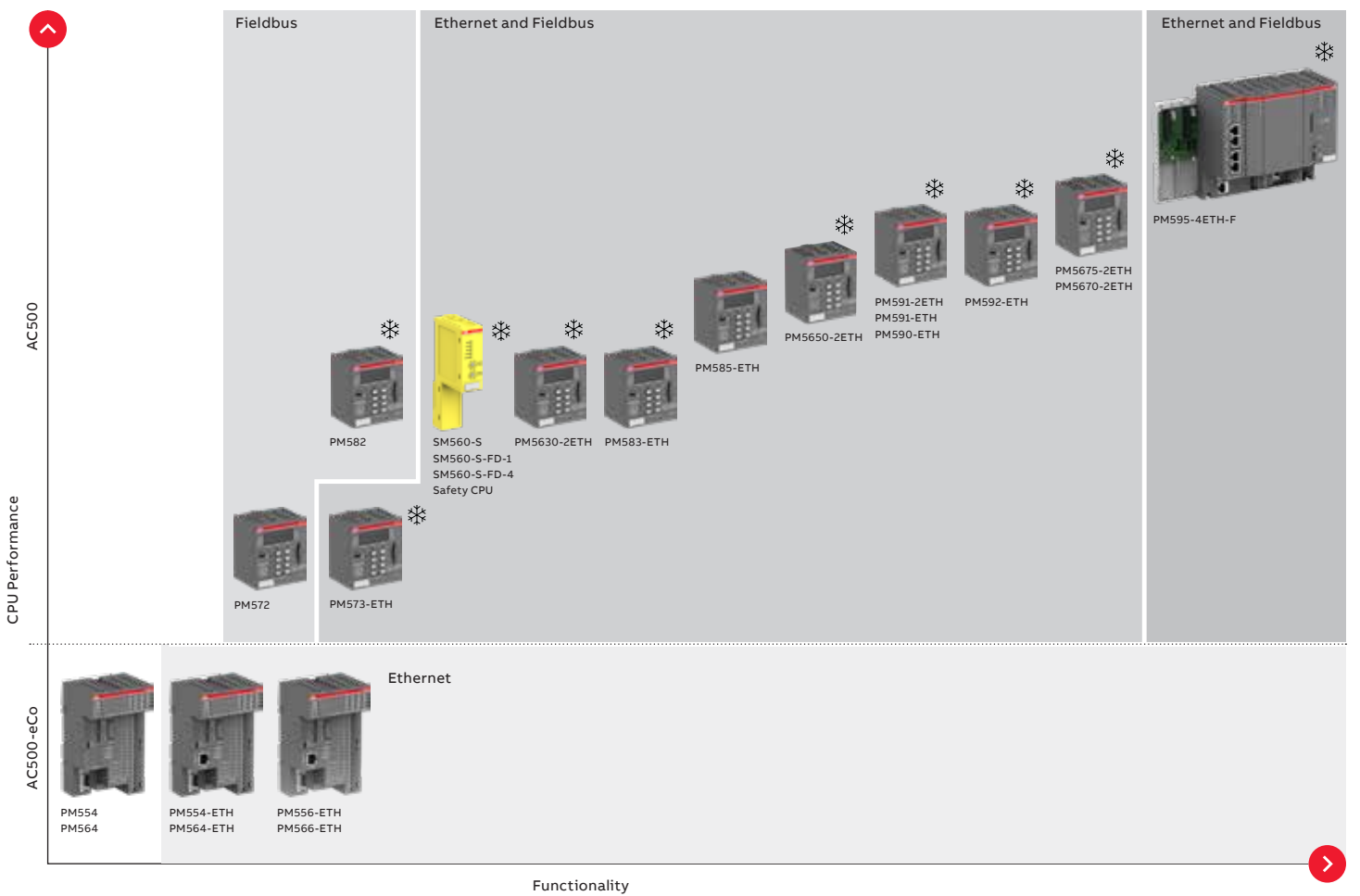

- Ethernet enabled
- Fieldbus enabled
- Ethernet, Fieldbus and High Availability enabled
- Ethernet, Fieldbus, High Availability and enlarged memory
- eXtreme Conditions version available

PLC Automation product family

PLCs at a glance...

	AC500-eCo	AC500	AC500 V3	AC500-S (2)
System configuration and application programming				
Automation Builder (common programming tool)	●	●	●	●
Application Features				
Extended temperature range				
Functional safety		●	●	●
Support of simple motion with FM562 module (1)	●	●	● (3)(5)	●
Support of coordinated motion (1)		●	● (3)(5)	●
Support of High Availability (HA)		●	●	
Hot Swap of attached I/Os mounted on Hot Swap terminal unit		● (9)	●	
CPU features				
	AC500-eCo	AC500	AC500 V3	AC500-S (2)
Performance (time per binary instruction)	0.08 μs	0.0006...0.06 μs	0.001...0.02 μs	0.05 μs
Program memory	128...512 kB	128 kB...16 MB	8...160 MB (8)	1...1.3 MB
User data memory	14...130 kB	128 kB...16 MB	8...160 MB (8)	1024 kB
Remanent data (= saved)	2 kB	12 kB...3 MB	256 kB ... 1.5 MB	120 kB
Serial communication				
RS232		●	●	●
RS485	●	●	●	●
Isolated interface	Option TA569-RS-ISO	●	●	●
CAN communication interface on CPU				
CANopen Master, J1939 and CAN 2A/2B protocols			●	
Ethernet features on CPU with integrated Ethernet or external communication module				
Online access (Programming)	● only onboard	●	● only onboard	●
ICMP (Ping), DHCP, IP configuration protocol	● only onboard	●	● only onboard	●
UDP data exchange, Modbus TCP	● only onboard	●	● only onboard	●
Ethernet features on CPU with integrated Ethernet only				
HTTP / HTTPS (integrated web server)	● / -	● / -	● / ●	● / -
HTML 5			●	
SNTP (Time synchronization)	●	●	●	●
FTP / FTPS server	● / -	● / -	● / ●	● / -
FTP client	● (7)	● (7)		● (7)
SMTP client (Simple Mail Transfer Protocol)	○	●	● (5)	●
IEC 60870-5-104 remote control protocol		●	●	●
KNX protocol			● (4)	
IEC61850 MMS Server, Goose			● (4)	
Network variables on UDP			●	
Socket programming		●	●	●
OPC DA (AC500 V2 and V3)	●	●	●	●
OPC UA server (AC500 V3 only)			●	
BACnet (B-ASC profile)	○ (4)	● (4)		● (4)
BACnet (B-BC profile)			● (5)	
Selectable protocol				
EtherCAT Master		● (6)	● (4)(5)	
PROFINET IO Controller		● (6)	● (4)(5)	
EthernetIP Adapter			● (4)(5)	
IEC 61850 protocol (MMS Server, GOOSE)			● (4)	
Capability to connect Fieldbus Modules		●	●	●
I/Os integrated on CPU	●			
I/O modules features				
	S500-eCo	S500	S500	S500-S (2)
Analog modules				
Configurable		●	●	
Dedicated	●			●
Digital modules				
Configurable	○	●	●	
Dedicated	●	●	●	●
Transistor outputs short circuit protected		●	●	●
Output diagnosis		●	●	●
Hot Swap of I/O modules (10)		●	●	
Extension with S500-eCo and S500(-XC) I/O modules	●	●	●	● (2)

AC500-XC	AC500-XC V3	AC500-S-XC (2)
●	●	●
●	●	●
●	●	●
●	● (3)(5)	●
●	● (3)(5)	●
●	●	
● (9)	●	
AC500-XC	AC500-XC V3	AC500-S-XC (2)
0.0006...0.06 μs	0.001...0.02 μs	0.05 μs
128 kB...16 MB	8...160 MB (8)	1...1.3 MB
128 kB...16 MB	8...160 MB (8)	1024 kB
12 kB...3 MB	256 kB...1.5 MB	120 kB
●	●	●
●	●	●
●	●	●
	●	
●	● only onboard	●
●	● only onboard	●
●	● only onboard	●
● / -	● / ●	● / -
●	●	●
● / -	● / ●	● / -
● (7)		● (7)
● (5) for V3	● (5) for V3	●
●	●	●
	● (4)	
	●	
●	●	●
●	●	●
	●	
● (4)		● (4)
	● (5)	
● (6)	● (4)(5)	
● (6)	● (4)(5)	
	● (4)(5)	
	● (4)	
●	●	●
S500-XC	S500-XC	S500-S-XC (2)
●	●	●
●	●	●
●	●	●
●	●	●
●	●	●
●	●	●
●	●	● (2)

- fully
- partly
- (1) Requires Library PS552-MC-E
- (2) AC500-S and AC500-S-XC require AC500 or AC500-XC modules to operate. The latter support all communication interfaces.
- (3) Requires new V3 Library
- (4) Licensed features
- (5) In preparation
- (6) PM595 and/or CPU V3 only
- (7) Application library download from "application examples"
- (8) Memory size is complete size for program and data with AC500 V3 CPU
- (9) As of PM585-ETH
- (10) Mounted on Hot Swap terminal unit when attached to AC500 CPU V2 as of PM585-ETH or AC500 CPU V3 or communication interface modules for Modbus TCP, PROFINET (CI501-PNIO, CI502-PNIO) or PROFIBUS.

PLC Automation product family

CPU Selector

		AC500-eCo		AC500
		PM5x4	PM5x6	PM57x
What does your project need?				
Basic	Compactness and onboard I/Os ?	●	●	○
	230 V AC power supply onboard ?	●	●	○
	Standard operational temperature ?	●	●	●
	Extreme environmental conditions (e.g. high temperature, humidity or vibrations) ?	-	-	● (XC)
Application feature	Functional Safety up to SIL3 ?	○	○	●
	Simple motion with PTO ?	●	●	●
	High-speed motion or interpolated motion ?	-	-	-
	Data logging ?	-	-	-
	Condition monitoring CMS ?	-	-	-
	High availability with CS31 protocol ?	-	-	○
	High availability with Ethernet Modbus TCP protocol ?	-	-	○
	HTML5 web server ?	-	-	-
	Telecontrol with IEC 60870-5-104 ?	-	-	○
	Process control objects library (PCO) for DCS integration ?	●	●	●
Application performance	More than 1 Cyclic and 1 Interrupt IEC61131 Task ?	○	○	●
	4 or more IEC61131 Tasks ?	-	-	-
	More than 2 kB retain variables ?	-	-	●
	User program / User memory ?	128KB/14KB	512KB/130KB	512KB/512KB
	Large flash disc for data collecting ?	-	-	-
	Web server data ≤ 1MB ?	●	●	●
	Web server data ≥ 4MB ?	-	-	-
	Floating point arithmetic calculation ?	-	-	-
	Number of Ethernet Sockets for parallel connection ?	≤ 13	≤ 13	≤ 13
	Number of Modbus TCP Sockets (part of Ethernet Sockets) ?	≤ 12	≤ 12	≤ 12
Communication/Fieldbus	CPU performance (ns per bit instruction) ?	80ns	80ns	60ns
	Decentralized I/Os or communication on serial CS31 fieldbus ?	●	●	●
	Decentralized I/Os or communication on serial Modbus RTU fieldbus ?	●	●	●
	Decentralized I/Os or communication on PROFIBUS DP master / slave fieldbus ?	-	-	● / ●
	Decentralized I/Os or communication on CAN/CANopen master / slave fieldbus ?	-	-	● / ●
	Decentralized I/Os or communication on Modbus TCP network ?	●	●	●
	Decentralized I/Os or communication on PROFINET IO controller / device network ?	-	-	● / ●
	Decentralized I/Os or communication on EtherCAT master network ?	-	-	●
	Two or more onboard Ethernet interfaces ?	-	-	-
	Onboard selectable protocols PROFINET IO / EtherCAT / EthernetIP ?	-	-	-
IEC61850 MMS / GOOSE protocol ?	-	-	-	
OPC UA server?	-	-	-	

- Not possible

○ Possible but not optimal solution

● Possible with additional devices

● Possible and best selection

(1) In preparation

(2) Total memory for code, data and web server

(3) Number of ETH Socket total is basically not limited, but depends on: CPU load, priority of application tasks, kind of used protocols, amount of data transferred, network structure

(4) Feature(s) is (are) licensed

PM5630 V3	PM58x	PM585-ETH	PM5650 V3	PM59x-ETH	PM591-2ETH	PM5670 V3	PM592-ETH	PM5675 V3	PM595-4ETH
●	●	●	●	●	●	●	●	●	●
●	●	●	●	●	●	●	●	●	●
●	●	●	●	●	●	●	●	●	●
● (XC)	● (XC)	-	● (XC)	● (XC)	● (XC)	● (XC)	● (XC)	● (XC)	● (XC)
●	●	●	●	●	●	●	●	●	●
●	●	●	●	●	●	●	●	●	●
-	-	●	-	●	●	-	●	-	●
○	○	○	●	●	●	●	●	●	●
-	-	-	-	-	-	-	●	-	-
-	●	●	-	●	●	-	●	-	●
●	○	●	●	●	●	●	●	●	●
●	-	-	●	-	-	●	-	●	-
●	○	○	●	●	●	●	●	●	●
-	●	●	-	●	●	-	●	-	●
●	●	●	●	●	●	●	●	●	●
○	○	●	●	●	●	●	●	●	●
●	●	●	●	●	●	●	●	●	●
8MB (2)	1MB/1MB	1MB/2MB	80MB (2)	2-4MB/2-4MB	4MB/4MB	160MB (2)	4MB/4MB	160MB (2)	16MB/16MB
○	○	○	○	○	○	○	4GB	8GB	4GB
○	○	○	○	○	○	○	○	○	○
see above (2)	4MB	4MB	see above (2)	8MB	8MB	see above (2)	8MB	see above (2)	16MB
●	-	●	●	●	●	●	●	●	●
Unlimited (3)	≤ 22	≤ 29	Unlimited (3)	≤ 29	≤ 61	Unlimited (3)	≤ 29	Unlimited (3)	≤ 61
30	≤ 12	≤ 12	50	≤ 12	≤ 28	120	≤ 12	120	≤ 28
20ns	50ns	4ns	10ns	2ns	2ns	2ns	2ns	2ns	0.6ns
-	●	●	-	●	●	-	●	-	●
●	●	●	●	●	●	●	●	●	●
● / ● (1)	● / ●	● / ●	● / ● (1)	● / ●	● / ●	● / ● (1)	● / ●	● / ● (1)	● / ●
● / ●	● / ●	● / ●	● / ●	● / ●	● / ●	● / ●	● / ●	● / ●	● / ●
●	●	●	●	●	●	●	●	●	●
● / ●	● / ●	● / ●	● / ●	● / ●	● / ●	● / ●	● / ●	● / ●	● / ●
●	●	●	●	●	●	●	●	●	●
●	-	-	●	-	●	●	-	●	●
● / ● / ● (1) (4)			● / ● / ● (1) (4)		-	● / ● / ● (1) (4)		● / ● / ● (1) (4)	● / ● / -
○ (4)	-	-	● (4)	-	-	● (4)	-	● (4)	-
●	-	-	●	-	-	●	-	●	-



AC500-eCo



AC500



AC500-XC



AC500-S



AC500-S-XC

PLC Automation product family

AC500-eCo – modular concept

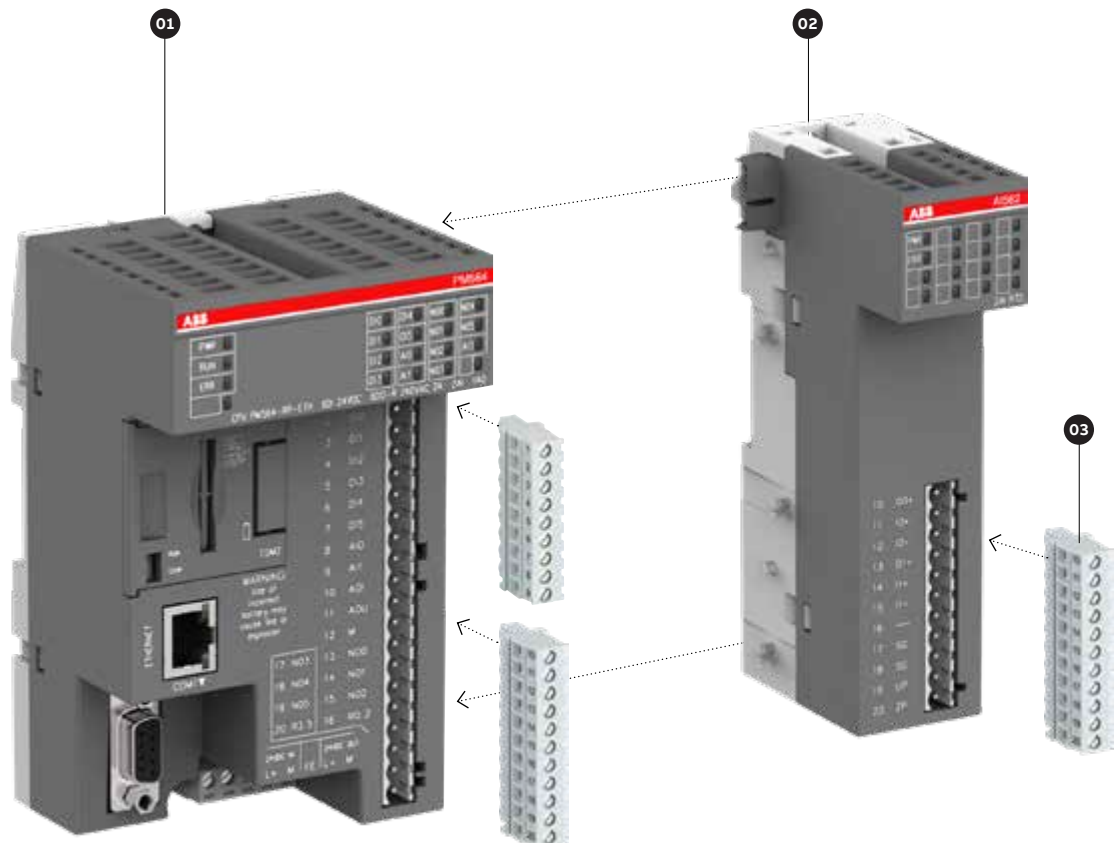

01 – AC500-eCo central processing unit (CPU)

- Different memory options
- Integrated communication option.

02 – S500-eCo I/O modules

- Up to 10 expansions
- Decentralized extension available.

03 – Terminal blocks

- Three types of pluggable terminal blocks available.

PLC Automation product family

AC500 and AC500-XC – modular concept

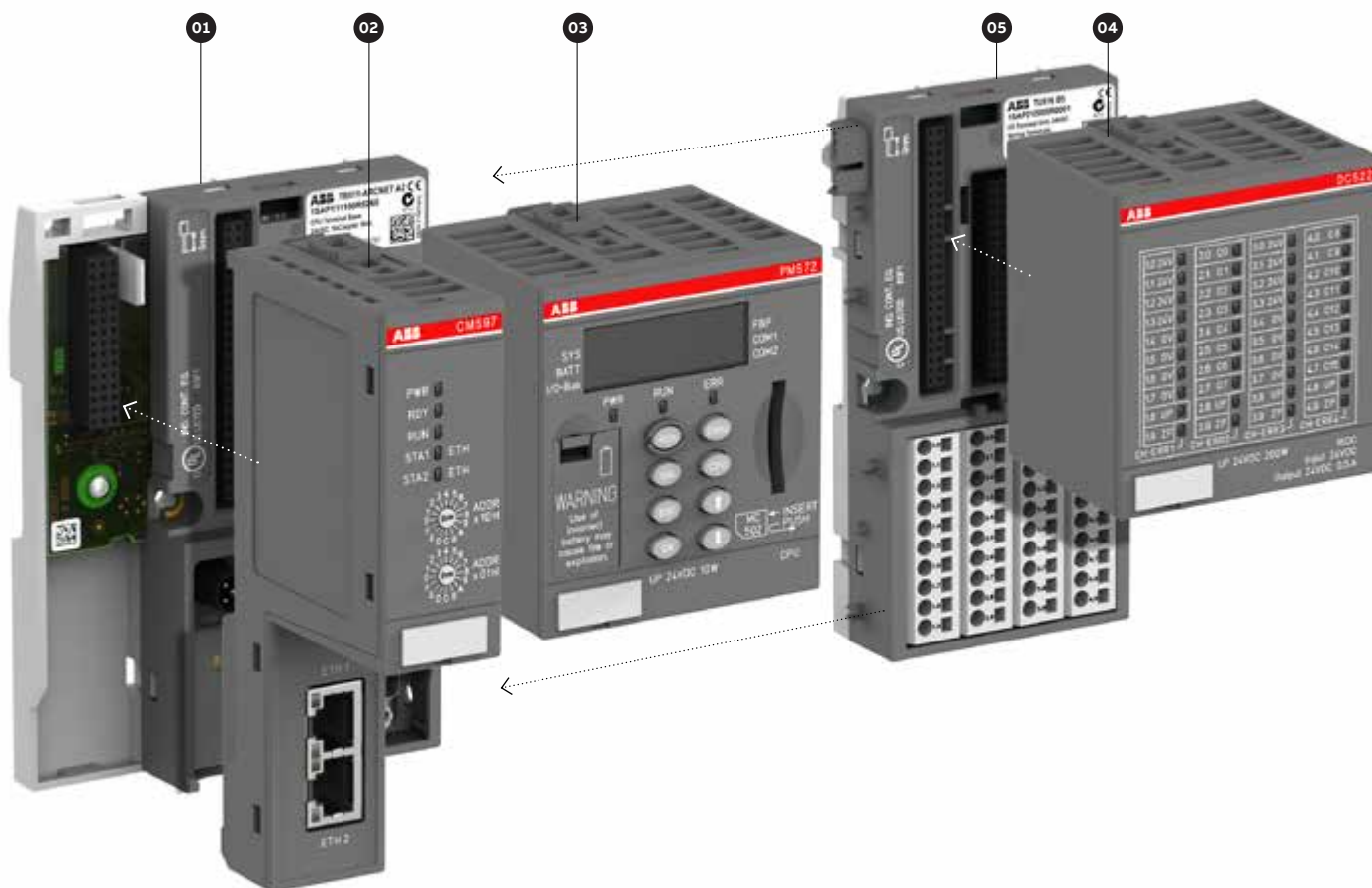

01 – Terminal base

- Common for all AC500 CPU types
- For 1, 2 or 4 communication modules
- With serial interfaces
- With 1 or 2 Ethernet interfaces
- New specific terminal base only for AC500 V3 CPU with 2 Ethernet interfaces and CAN interface.

02 – Communication modules

- For PROFIBUS DP, Ethernet, Modbus TCP, EtherCAT, CANopen, PROFINET IO or serial programmable
- Up to 4 pluggable
- Up to 6 pluggable for AC500 V3 CPU in development.

03 – AC500 central processing unit (CPU)

- Different performance, memory, network, operating conditions options
- Integrated communication
- New AC500 V3 CPU with large memory and high performance (requires new specific terminal base).

04 – S500 I/O modules

- Up to 10 expansions
- Decentralized extension available.

05 – Terminal units

- Up to 10 terminal units
- Decentralized extension available.

PLC Automation product family

AC500-eCo system characteristics

Locally, AC500-eCo CPUs are expandable with up to 10 I/O modules. AC500-eCo CPUs with different performance levels are available.

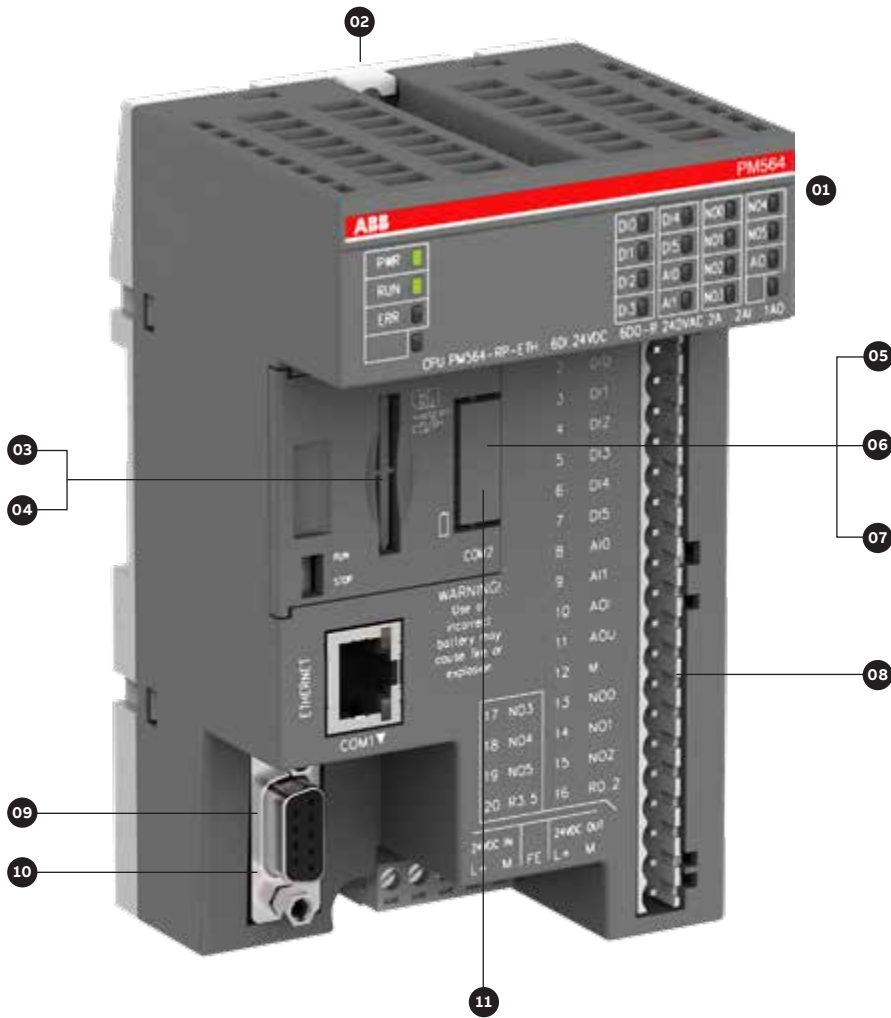

—
01 AC500-eCo CPUs are locally expandable with up to 10 I/O modules (standard S500 and S500-eCo I/O modules can be mixed).

—
02 Wall mounting

—
03 SD-card adapter

—
04 SD-card

—
05 Adapter with realtime clock

—
06 Adapter with COM2 & realtime clock

—
07 Adapter with COM2

—
08 Terminal blocks

—
09 RS485 isolator for COM1

—
10 COM1 USB

—
11 COM2 USB programming cable

—
12 AC500-eCo Starter kit. For more information, see page 234

—
13 Input simulator



01



02



03



04



05



06



07



08



09



10

11



12



13

PLC Automation product family

AC500 system characteristics

AC500 offers superior local expansion capabilities for I/O communication, best-in-class CPU functionality and industry-leading performance.



—
01 AC500 CPUs are locally expandable with up to 10 I/O modules (standard S500 and S500-eCo I/O modules can be mixed).

—
02 Terminal base / Terminal base V3

—
03 Communication module
Up to 4 modules for multiple combinations to communicate on nearly every protocol available
Up to 6 modules can be used with AC500 V3 CPU

—
04 CPU module / CPU V3 module

—
05 S500 Terminal unit

—
06 S500 I/O module

—
07 Pluggable marker holder for S500 I/O modules with template

—
08 S500-eCo I/O module

—
09 SD-card

—
10 Battery



—
01



—
02



—
03



—
04



—
05



—
06



—
07



—
08



—
09



—
10

PLC Automation product family

AC500 PM595 controller system characteristics

The flagship of the AC500 platform, the AC500 PM595 Controller, was designed to be as scalable, flexible and efficient as the entire AC500 range.

With the AC500 CPU PM595, ABB launched a new core for machine control applications. Its high-performance processor with generous memory offers performance, security and reliability for the upcoming challenges of automation applications.

A variety of connectivity capabilities, integrated safety and utilizability even under rough environment provide machine builders with valuable benefits when performing their automation tasks.

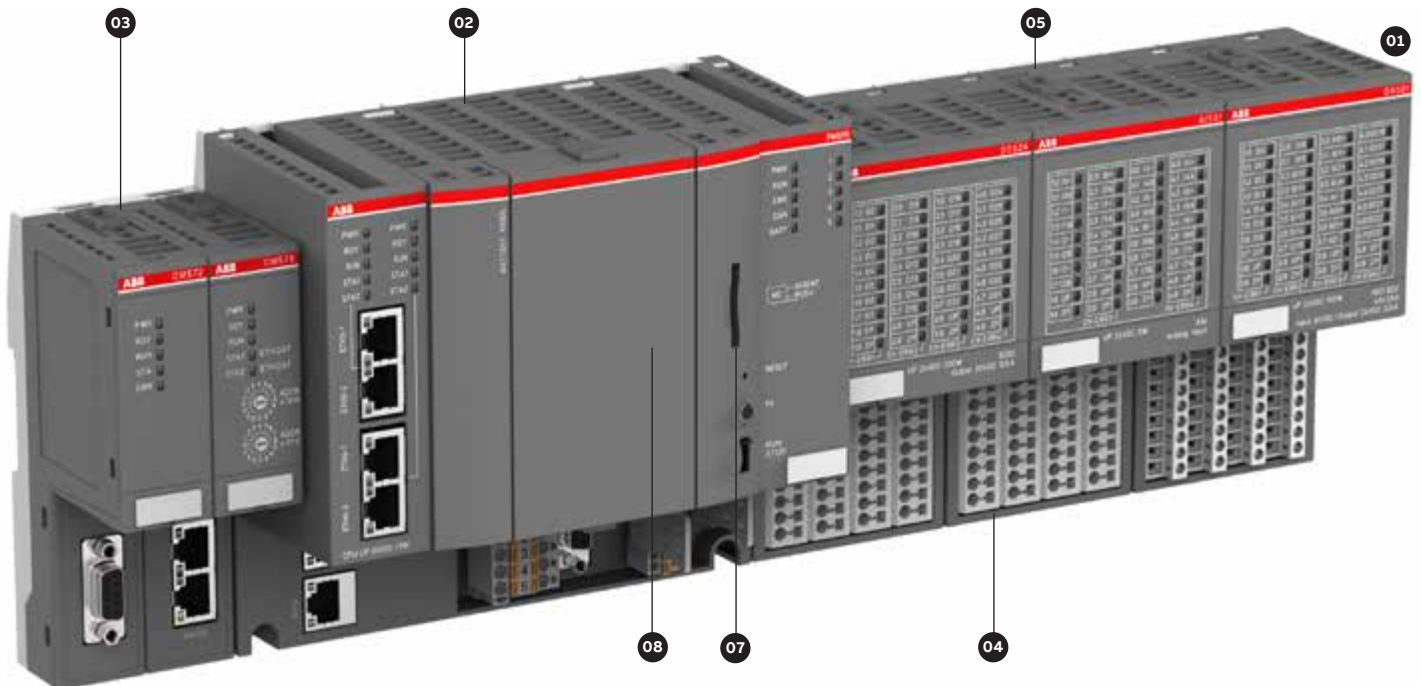

—
01 AC500 CPUs are locally expandable with up to 10 I/O modules (standard S500 and S500-eCo I/O modules can be mixed).

—
02 CPU with integrated connectivity and terminal base

—
03 Communication module.
Up to 2 modules for multiple combinations to communicate on nearly every protocol available and to include functional safety

—
04 S500 Terminal unit

—
05 S500 I/O module

—
06 S500-eCo I/O module

—
07 SD-card

—
08 Battery

—
09 Pluggable marker holder for S500 I/O modules with template



01



02



03



04



05



06



07



08



09

PLC Automation product family

Condition monitoring system CMS based on AC500

Predictable performance for your operations

Optimize your assets with a condition monitoring system (CMS) based on the proven AC500 platform. The new FM502 module can help you to improve your operations resulting in greater efficiency and higher reliability while minimizing service and operating costs.

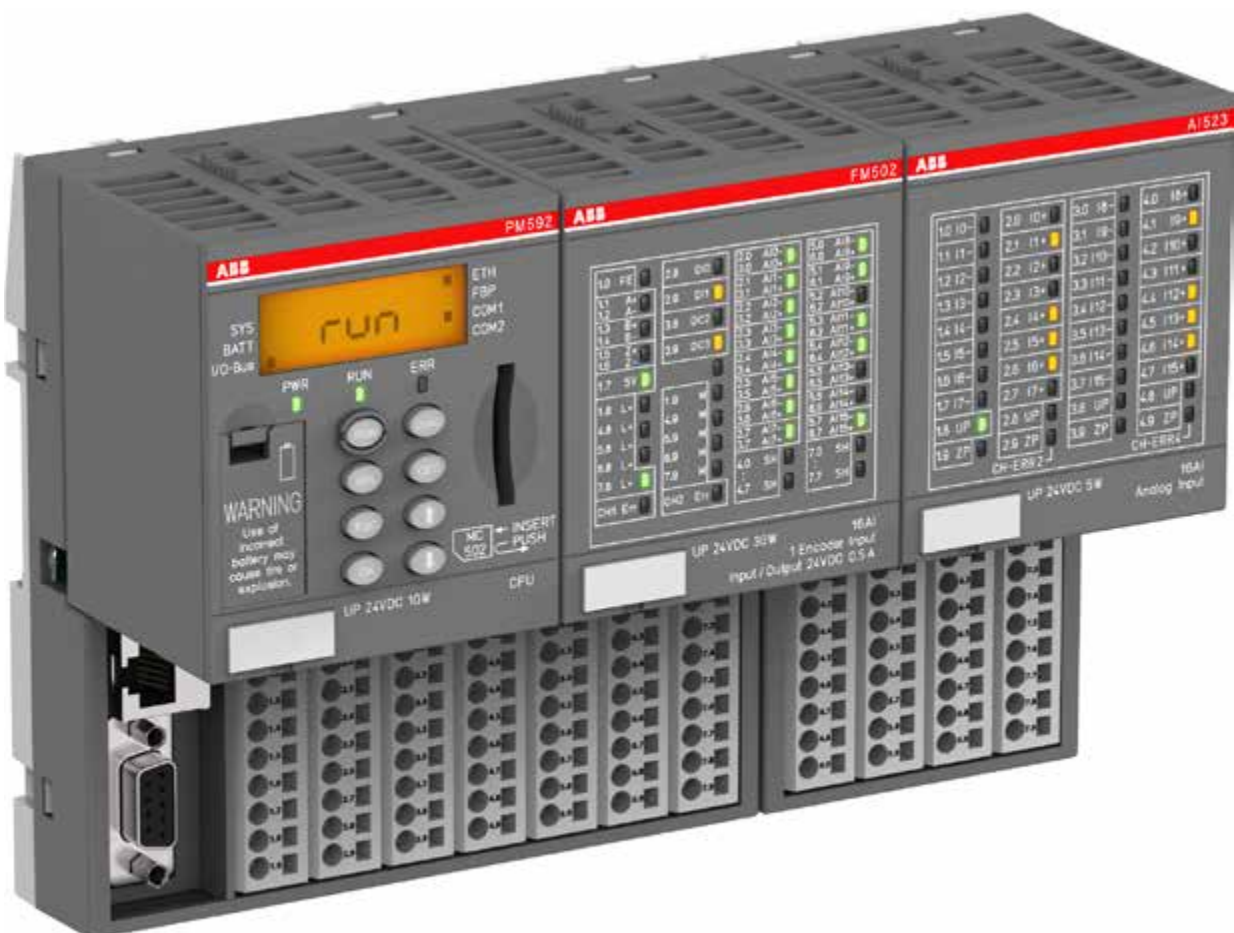

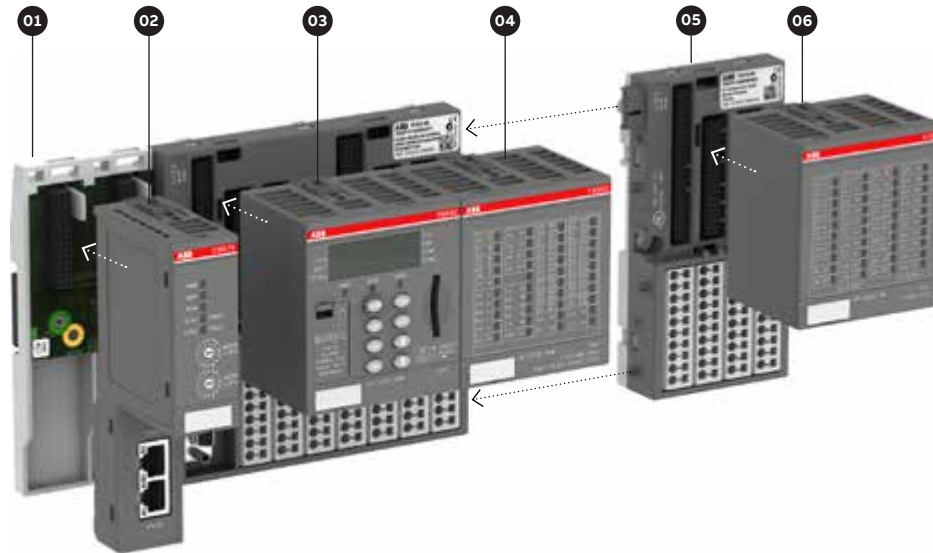

- 01 Terminal base: TF501 or TF521
- 02 Accomodating: 0 - 2 communication modules
- 03 PM592 CPU
- 04 FM502 CMS module
- 05 Expandable by I/O terminal units
- 06 Expandable by further I/O modules

Add predictable performance and productivity
 The new CMS module brings further reliability and easy integration with all kinds of machinery systems, enabling precise management of the real-time condition of your operation. This transparency takes your business and productivity to a new level with more efficient machines, predictable performance and significant reduction in maintenance costs.

No matter whether as stand-alone condition monitoring or integrated into machine or process control, the module is perfectly suited to build optimized, self-analyzing automation solutions that simultaneously perform condition monitoring, control, protection, safety and data logger functions with one controller. The fast data logger function also contributes to consistent high quality production, due to the possibility to combine control and production information directly.

CMS also protects against machine failures, unforeseen sudden damage, incorrect installation, and reduces maintenance and wear. Virtually no unscheduled downtimes boost plant availability and reliability.

Advantages

- Planned maintenance rather than spontaneous repair ensures predictable performance
- Approaching damage is identified very early
- Protection against spontaneous failures and operation in critical conditions
- Reduction of costs in maintenance and lost production time
- Plant availability is increased
- Optimum utilization of the aggregates until real end of life
- Simple to use, maintain, adapt or expand

AC500 + CMS = increased machine efficiency

All based on the AC500 platform modularity provides ultimate flexibility: Communication and I/O modules can be added and combined with Safety.

Expandable, robust and proven

- Stand-alone CMS or control integrated
- Expandable by AC500 communication modules and S500 I/O modules
- Proven and future proof, as based on AC500 platform
- Extreme conditions XC version available
- Fast data logger, e. g. for production quality
- Condition monitoring and fast protection (vibration, current, voltage, speed/encoder)

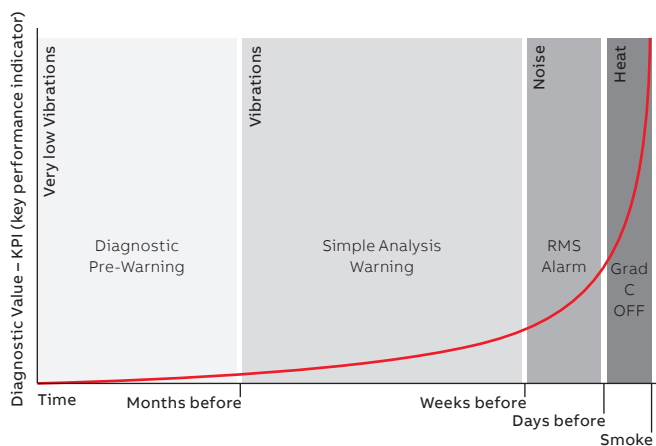

PLC Automation product family

AC500 V3

AC500 V3 delivers new features and higher performance

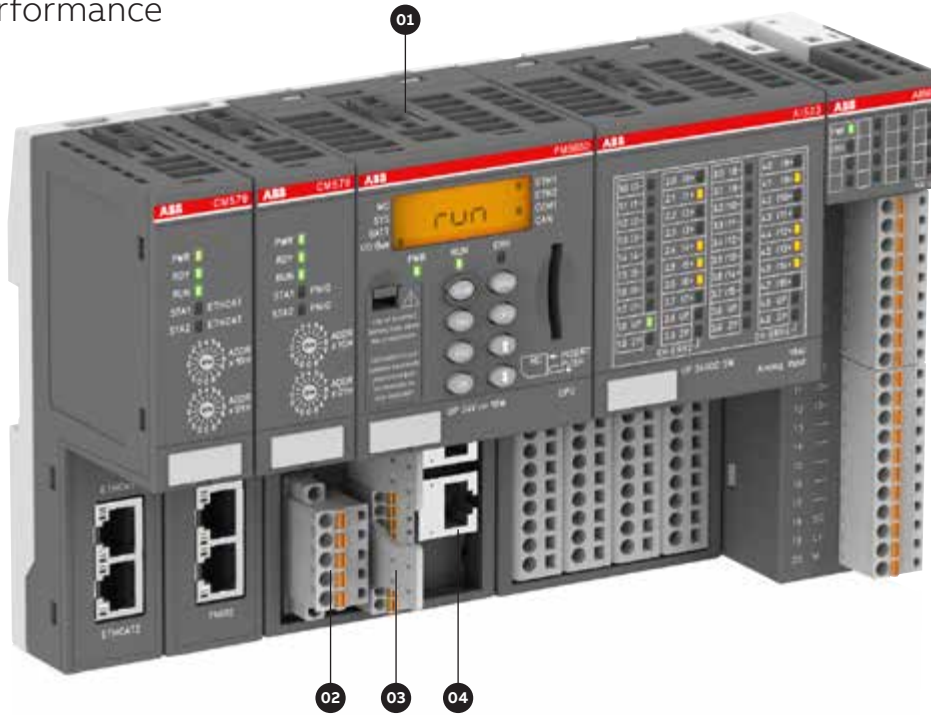

- 01 PM5650-2ETH CPU module
- 02 One CAN serial interface
- 03 One COM1 serial interface
- 04 Two Ethernet interfaces on RJ45

New CPU range PM56xx with higher hardware performance and state-of-the-art features, such as OPC UA, WebVisu, Object oriented programming, selectable fieldbus protocols, and much more.

Improved features and performance

The AC500 platform features a new more powerful CPU with larger memory for various automation solutions ranging from simple to complex motion control applications.

The integrated Ethernet switch simplifies the network architecture, making additional external switches obsolete, and thereby also saving cabinet space. Fewer hardware types facilitate spare-parts stocking thus increasing flexibility.

The CPU also provides an integrated CAN / CANopen interface offering an easy-to-use and fast connection to remote I/Os or drives. Various CAN protocols, e.g. CANopen Master and Slave (*), J1939 or CAN 2A/2B are available, and modular CAN is also supported.

Improved application flexibility and facilitated customer engineering

Fewer hardware products but more configurable and licensed features allow for customizing the product according to your specific application.

From 8 MB to up to 160 MB of memory and dynamic allocation to User Data, Program or Web Server, the new CPU meets almost every application requirement by adapting its configuration according to your needs.

State-of-the-art features tailored to your needs

Improved communication features integrated in the CPUs lower hardware costs and reduce the number of versions. Compatibility (*) with existing S500 / S500-eCo I/O modules, communication modules, communication interface modules and AC500-S safety modules of the existing AC500 PLC platform.

(*) in preparation

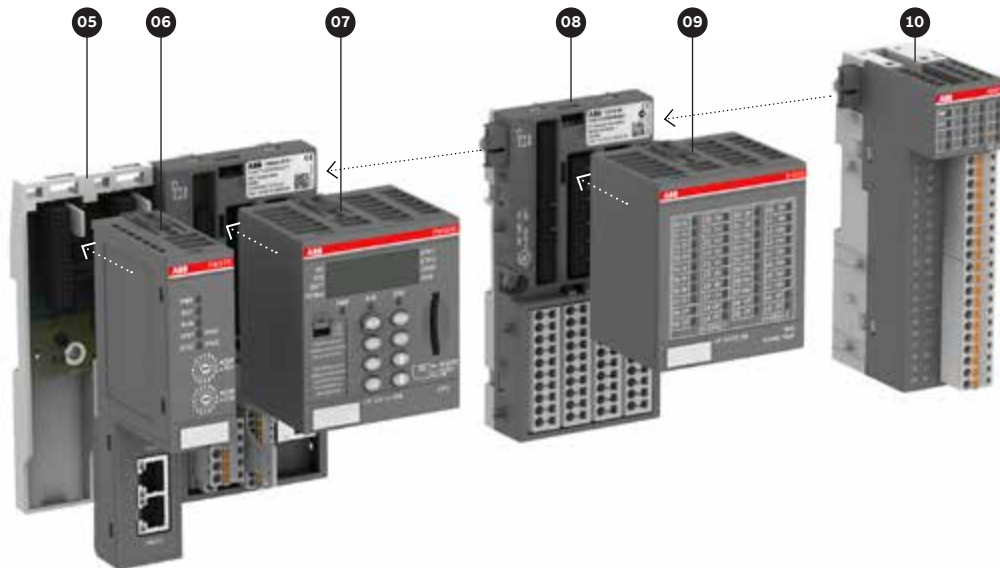

- 05 Terminal base: TB5xxx-2ETH
- 06 Accommodating: 0, 1, 2, 4 or up to 6 communication modules
- 07 PM56xx-2ETH CPU module
- 08 Expandable by I/O terminal units
- 09 Expandable by further I/O modules from the S500 product range
- 10 or S500-eCo product range

Connection to third-party systems in open architecture

Standardized protocols or features such as OPC UA save time and costs and simplify the connection to SCADA.

New Web Server based on HTML 5

Two embedded Ethernet Interfaces:

- Independent (2xMAC) or Switched
- A lot of onboard ETH features:
 - OPC UA Server (easier connection to SCADA, panels, third-party, IoTSP)
- Modbus TCP client/server
- IEC 60870 (with new features)
- Network variables (UDP)
- IEC 61850 protocol licensed

Reduced cabinet space with more integrated features

Integrated interfaces and configurable protocols reduce the CPU size thus saving cabinet space.

Reliability and security

Signed boot project, Firmware and secure download protect your application from unauthorized changes and HTTPs and FTPs strengthen your protection.

Functional safety

Reusing AC500-S safety solutions (*) provides state-of-the-art safety features and reduces engineering time.

Protection of customer investment

Reusing AC500/S500 products protects your investments and allows easy upgrades / migration from current applications to the latest technology for the coming years.

The PM56xx CPU can be used only with the new terminal base range TB56xx but can reuse many existing AC500 platform products like I/O modules, communication modules, etc.

Improved engineering, programming and debugging

Running on the new AC500 V3 CPU, several new features of the Automation Builder software make the AC500 platform more powerful and easier to use:

- Professional Version Control with subversion - application project management
- Object-oriented programming
- New optimized editors for IEC programming languages
- Static code analysis
- Profiler for PLC application performance optimization

For details, please refer to Automation Builder 2.0, section Productivity features page 60.

(*) in preparation

PLC Automation product family

Extreme conditions

AC500-XC – the rugged variant of AC500 for extreme indoor and outdoor conditions.

The PLC AC500-XC is reliable, functionally safe and operational even under rough environmental conditions.





04



01



02



03



05



06

- 01 Terminal base
- 02 Extreme conditions communication module
- 03 Extreme conditions CPU
- 04 Extreme conditions CPU with integrated connectivity and terminal base
- 05 Extreme conditions S500 terminal unit
- 06 Extreme conditions S500 I/O module



Operation in extremely humid environments

- Increased resistance against 100 % humidity and condensation.



Extended operating temperature

- -40 °C up to +70 °C operating temperature.



Reliable in high altitudes

- Operation in altitudes up to 4000 m above sea level or air pressures up to 620 hPa.



Extended immunity to corrosive gases and salt mist

- G3, 3C2 / 3C3 immunity
- Salt mist EN 60068-2-52 / EN 60068-2-11.



Extended immunity to vibration

- 4 g rms random vibration up to 500 Hz
- 2 g sinusoidal vibration up to 500 Hz.



Extended EMC requirements

- EN 61000-4-5 surge immunity test
- EN 61000-4-4 transient / burst immunity test.

PLC Automation product family

Functional Safety

AC500-S safety PLC is the solution for both simple and complex machine and process safety applications requiring maximum reliability, efficiency and flexibility.

This safety PLC protects people, machines and processes, the environment and investments - the ideal choice for wind turbine, crane, material handling, hoist, robot and other factory and process applications.

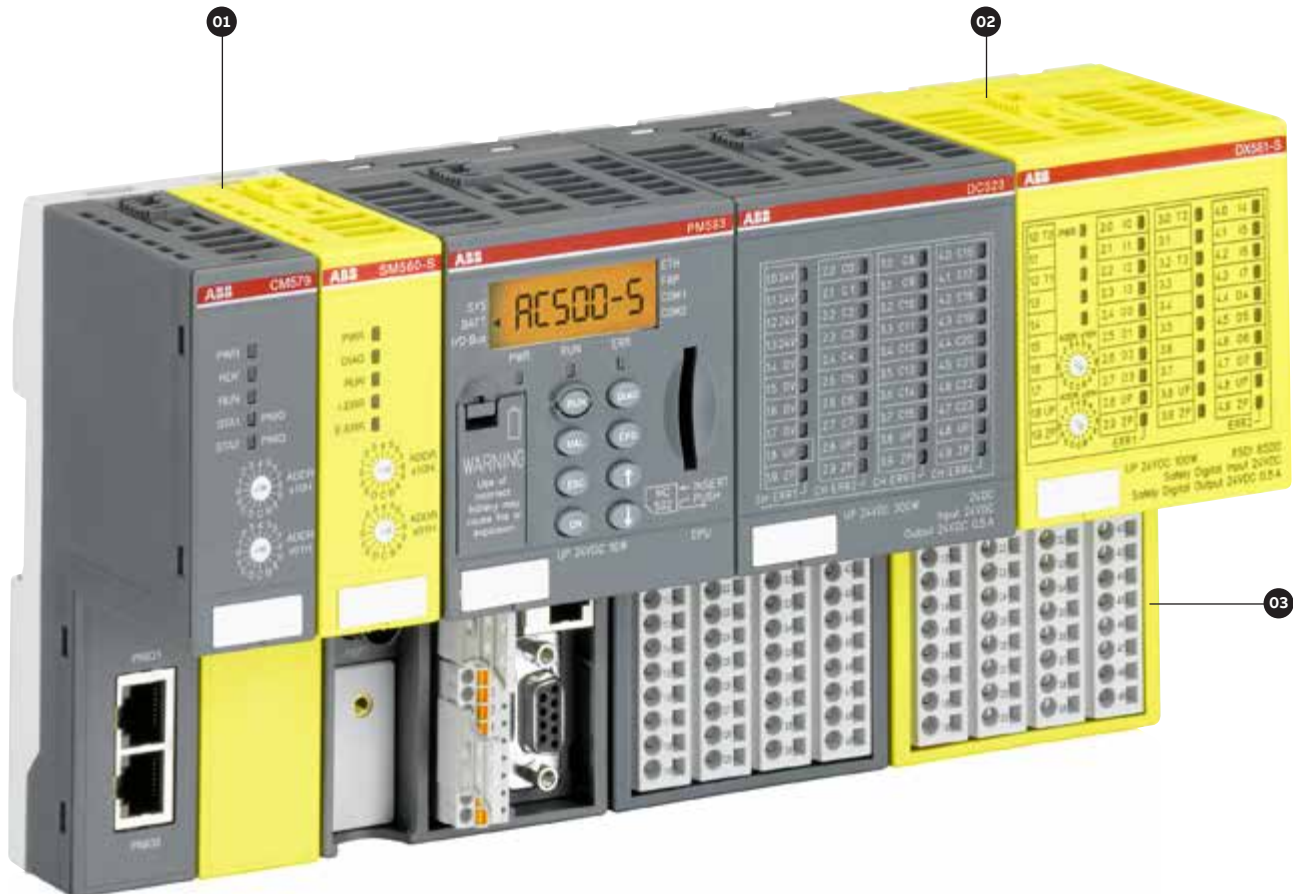



01



02



03

- 01 Safety CPU
- 02 S500 Safety I/O module
- 03 Safety terminal unit

Better integration and ease of programming
 Featuring a consistent look and feel across the entire range, the AC500 is the PLC of choice for applications where uncompromised flexibility, comprehensive integration and seamless communication are a must. Automation Builder seamlessly integrates your safety application in ABB PLC, Safety, Drives, Motion and HMI. Through integrated standard languages, such as IEC 61131-3, Automation Builder is easy to use, thus, allowing you to get started in virtually no time at all. And what is more: intuitive system configuration using one single tool ensures optimal transparency.

The AC500-S safety PLC facilitates the implementation of even most complex safety applications. Support of safety-relevant calculations, such as COS, SIN, TAN, ASIN, ACOS and LOG makes the AC500-S the ideal solution for crane engineering, wind power generation, robotics and hoisting applications. Safety programming with Structured Text (ST) and full support for Function Block Diagram (FBD) and Ladder Diagram (LD) programming and advanced features in PROFIsafe over PROFINET communication, like Shared Device functions, gives you greater flexibility and simplifies safety application development. The AC500-S safety PLC is also available in a version for extreme conditions.

PLC Automation product family

CP600-eCo, CP600 and CP600-Pro control panels at a glance ...

ABB offers a wide range of scalable PLCs and robust HMI control panels.

With comprehensive but easy-to-use functionalities, ABB control panels stand out from competitor products. At one single touch, they intuitively provide operators with tailor-made operational

information for production plants and machines. CP600-eCo, CP600 and CP600-Pro control panels make machine operation efficient, predictable and user-friendly.

New comprehensive CP600 control panels platform for different applications

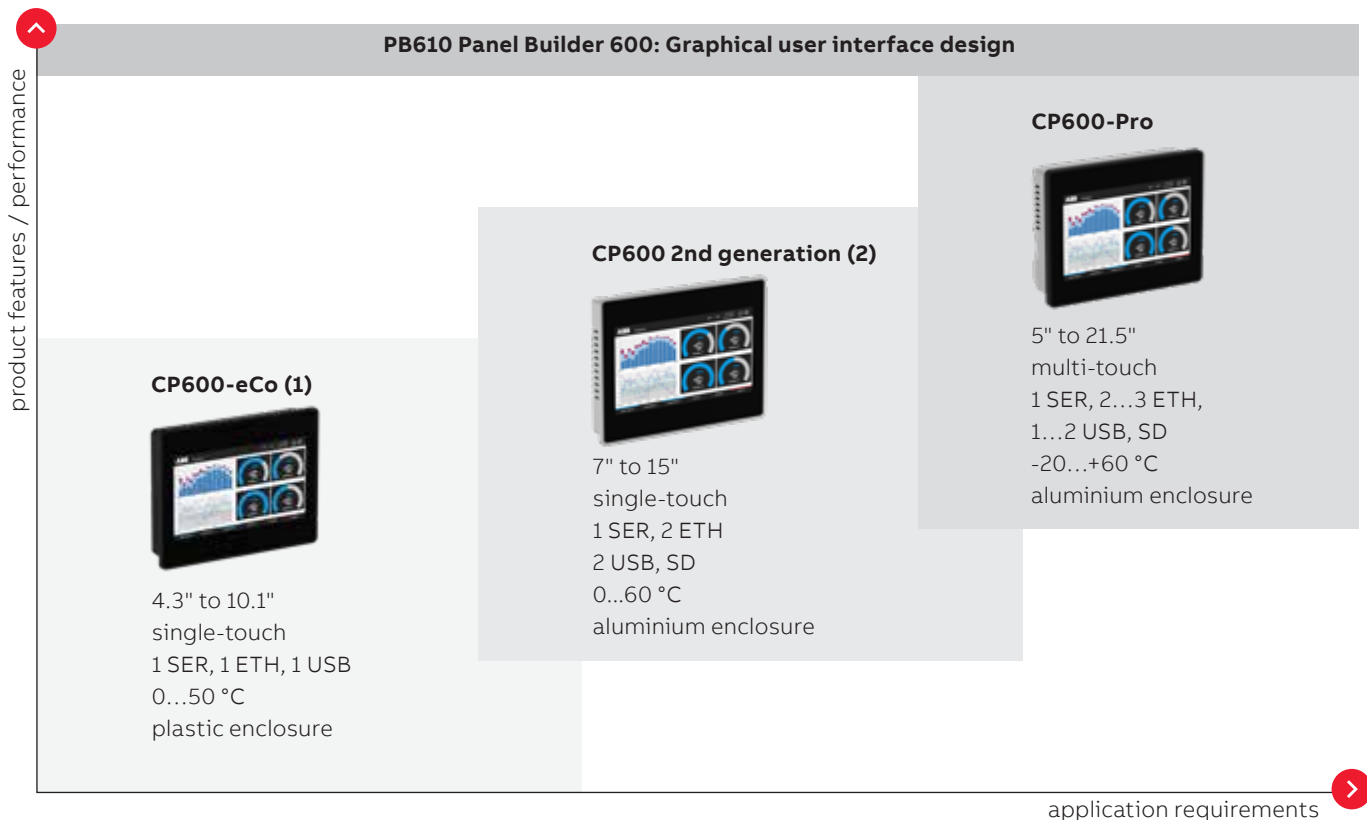

(1) CP600-eCo is available with ABB front design as well as black.

(2) CP600 is available in parallel to CP600 2nd generation. For details refer to chapter 7.



CP600-eCo, CP600, CP600-Pro

Wide range of control panel offerings in three assortments. Ideal choice for visualization of AC500 PLC platform automation solution.

The economical CP600-eCo control panel is aimed for standard functions and high usability for clear interaction with the operation process.

The robust CP600 2nd generation HMI provides state-of-the-art performance, versatile communication and representative design for machines and systems.

The CP600-Pro HMI comes with high end visualization performance, multi-touch operation, versatile trendsetting communication and representative design.

Due to the good scalability between CP600-eCo, CP600 and CP600-Pro, CP600-eCo HMI applications can be re-used easily for CP600 or CP600-Pro control panels and vice versa.

PB610 Panel Builder 600

PB610 Panel Builder 600 is the engineering tool for the entire CP600 control panels platform. PB610 Panel Builder 600 software is integrated in the Automation Builder engineering suite. For integration into a couple of third party automation systems, drivers are available. OPC UA client and server support future-orientated communication solutions.

What does your application need ?

	CP600-eCo	CP600 2nd gen. (1)	CP600-Pro
Screen sizes	sizes from 4" to 10" 4.3", 7", 10.1"	sizes from 7" to 15" 7", 10.4", 15"	wide range from 5" to 21" 5", 7", 10.1", 15.6", 21.5"
Operation	single-touch	single-touch	multi-touch
Communication	1 SER, 1 ETH, 1 USB	1 SER, 2 ETH, 2 USB, 1 SD	1 SER, 3 ETH (2), 2 USB (3), 1 SD
Operating temperature	0...50 °C	0...60 °C	-20...+60 °C
Enclosure	plastic / glass + front foil	aluminium / glass + front foil	aluminium / real glass
Operating system	Linux	Linux	Linux
PB610 application	60 MB	150 MB	240 MB (4)

(1) CP600 is available in parallel to CP600 2nd generation. For details refer to chapter 7.

(2) CP6605: 2 ETH

(3) CP6605: 1 USB

(4) CP6605: 60 MB

PLC Automation product family

CP600-eCo control panels



Economic HMI range for basic applications

Control panels in three different screen sizes from 4.3" to 10.1" in ABB design or just black provide HMI functions typically required for basic applications. The engineering tool PB610 Panel Builder 600, part of Automation Builder, ensures easy scalability on the CP600 platform.

Designed for basic applications

- The widescreens available in 4.3", 7" and 10.1" are suitable for many applications.
- Protocols for ABB PLCs, machinery and motion drives for Ethernet and serial connection make these control panels first choice for ABB automation solutions.
- OPC UA client and server functions make them well prepared for future communication solutions.
- Engineering by means of PB610 Panel Builder 600, part of ABB's Automation Builder, facilitates integration into automation packages and enables good scalability on the CP600 platform for different applications.

Slim industrial design

The slim plastic enclosure in attractive industrial design with a mounting depth of 29 mm enables installation even in narrow spaces. All connectors are located on one side. Landscape and portrait mounting options provide installation flexibility and various HMI presentations. These devices are available either in ABB design or in black.

State-of-the-art connectivity

- Ethernet interface 10/100 Mbit for easy connectivity to ABB automation components.
- Flexible serial connectivity to automation components without Ethernet interface.
- USB host for flexible data storage and easy updating.

PLC Automation product family

CP600 2nd generation control panels



New state-of-the-art HMI range for diverse applications

Three new control panels in screen sizes of 7", 10.4" and 15" provide comprehensive HMI functions for a wide range of applications. The engineering tool PB610 Panel Builder 600, part of Automation Builder, ensures easy scalability on the CP600 platform. Same front dimensions, cutouts and screen resolutions support an easy replacement of current CP600 control panels.

Tailor made for diverse applications

- Three different screen sizes with standard aspect ratio or widescreen from 7" to 15" are suitable for a lot of different applications.
- Protocols for ABB PLCs, machinery and motion drives for Ethernet and serial connection make these control panels first choice for ABB automation solutions. The IRC5 protocol enables easy direct communication with ABB robot controllers.
- OPC UA client and server functions make them well prepared for future communication solutions.

- Engineering by means of PB610 Panel Builder 600, part of ABB's Automation Builder, facilitates integration into automation packages and enables good scalability of the CP600 platform for various applications.

Solid design, wide operating temperature range

The robust aluminum enclosure in attractive industrial design, providing all connectors on one side, enables installation in various environments. Wide operating temperature range up to 60 °C makes these panels suitable for even challenging environments. Landscape and portrait mounting options provide installation flexibility and various HMI presentations.

Various options for flexible connectivity and data storage

- 2 Ethernet interfaces 10/100 Mbit with configurable bridge mode for easy connectivity with ABB automation components.
- Flexible serial connectivity with automation components without Ethernet interface.
- USB hosts for the flexible connection of accessories or data storage and easy updating.
- SD card slot for easy data storage and updating.

PLC Automation product family

CP600 control panels



Comprehensive HMI range for versatile applications

Various control panels in screen sizes from 4.3" to 15" provide comprehensive HMI functions for a wide range of applications. The range is completed by panels in sanitary design (page 41) as well as black variants. The engineering tool PB610 Panel Builder 600, part of Automation Builder, ensures easy scalability on the CP600 platform.

Various designs for diverse applications

- Seven different screen sizes with standard aspect ratio or widescreen from 4.3" to 15" are suitable for the most diverse applications.
- Protocols for ABB PLCs, machinery and motion drives for Ethernet and serial connection make these control panels first choice for ABB automation solutions. The IRC5 protocol enables easy direct communication with ABB robot controllers.
- OPC UA client and server functions make them well prepared for future communication

solutions.

- Engineering by means of PB610 Panel Builder 600, part of ABB's Automation Builder, facilitates integration into automation packages and enables good scalability on the CP600 platform for versatile applications.

Solid aluminum design

The robust aluminum enclosure in attractive industrial design, providing all connectors on one side, enables installation in various environments. Landscape and portrait mounting options provide installation flexibility and various HMI presentations.

Various options for flexible connectivity and data storage

- 2 Ethernet interfaces 10/100 Mbit with integrated switch for easy connectivity to ABB automation components.
- Flexible serial connectivity to automation components without Ethernet interface.
- USB hosts for the flexible connection of accessories or data storage and easy updating.
- SD card slot for easy data storage and updating.

PLC Automation product family

CP600 sanitary design control panels



Control panels in sanitary design for demanding applications

Hygienic standards and cleaning procedures in food & beverage applications typically require a special design of the relevant automation components. Human machine interfaces (HMIs) for meat processing have to comply with really challenging requirements. As a consequence e.g. mixers and cutters for meat processing are usually still equipped with conventional lamps and switches instead of state-of-the-art HMIs.



The CP635-FB and CP635-FW control panels are especially designed for reliable operation in harsh environments such as mixers in meat processing. These panels withstand the demanding cleaning procedures in meat processing better than most of the similar products in the market: stainless steel frame, rounded edges and front protection class IP69K make them withstand harsh cleaning procedures with high-pressure hot water jets directed at the equipment in different angles according to the relevant hygienic standards.

The displays of the control panels CP635-FB and CP635-FW are brighter than standard units, because of real glass screens. This ensures clear information for operators/users even in bright environments. Capacitive touch screens enable quick and easy operation even with gloves.

PLC Automation product family

CP600-Pro control panels



Outstanding HMI range designed for challenging applications

New control panels in screen sizes from 5" to 21.5" provide comprehensive HMI functions with multi-touch operation for a wide range of applications. Real glass fronts and an increased operating temperature range of -20...+60 °C make them first choice even for harsh environments. The engineering tool PB610 Panel Builder 600, part of Automation Builder, ensures easy scalability on the CP600 platform.

New multi-touch control panels for high-end applications

- The portfolio includes five screen sizes from 5" to 21.5", all widescreen, with multi-touch real glass screens for demanding high-end applications.
- The wide range of operating temperatures of -20...+60 °C makes them suitable for versatile applications and first choice for demanding ones.
- Protocols for ABB PLCs, machinery and motion drives for Ethernet and serial connection make these control panels preferred option for ABB automation solutions.
- OPC UA client and server functions make them well prepared for future communication solutions.

- Engineering by means of PB610 Panel Builder 600, part of ABB's Automation Builder, facilitates integration into automation packages and enables good scalability on the CP600 platform for versatile applications.

Real glass front and solid aluminum enclosure

CP600-Pro control panels have real glass fronts and robust aluminum enclosures in attractive industrial design, with all connectors located on one side, for installation in various even demanding environments. Landscape and portrait mounting options support installation flexibility for various HMI presentations.

Flexible connectivity and data storage with a view to the future

- Up to 3 Ethernet networks with different physical layers for easy connectivity to ABB automation components for upcoming networking concepts.
- Flexible serial connectivity to automation components without Ethernet interface.
- USB hosts for connecting printers and accessories, data storage and updating.
- SD card slot for easy data storage and updating.



PLC Automation product family

Mobile / remote access to HMI

Mobile / remote access to HMI

All control panels of the CP600 platform provide a web server for flexible access to HMI applications via mobile devices: PB610 Panel Builder 600 enables easy creation of HTML5 pages for mobile devices like smartphones, tablets etc. within standard HMI applications. Remote devices can log in to the HMI application without installation of an app.



PLC Automation product family

PB610 Panel Builder 600

Engineering tool for easy design of tailor-made graphical user interfaces for the entire CP600 platform

PB610 Panel Builder 600 software is integrated in the Automation Builder engineering suite and can be downloaded via Automation Builder installer.

Tailor-made human machine interface (HMI)

- For the efficient design of flexible HMI applications in versatile automation solutions.
- Vector graphics (*.SVG) for precise, easily scalable and dynamic HMI design.
- Alpha blending for realistic transparency effects.
- Libraries including rich sets of widgets – ready-to-use graphical objects.
- Easy creation of customized widgets through the combination/modification of standard widgets.
- Customized widgets clearly arranged in user galleries.

- Page templates for professional design.
- Numerous configuration options for all HMI elements.
- Realization of customized functions and individual dynamic manipulation via Java Script with debugger.
- Easy data acquisition and trend presentation.
- Reliable user management and secure access control.
- Rich set of configurable features: dynamic objects, data acquisition, alarm handling, multi-language applications, recipes, ...
- HMI simulation for efficient commissioning.
- Numerous drivers for easy connection to e.g. PLCs, drives, robots.
- OPC UA client and server for future-orientated cloud connectivity and IoT.
- Gateway function for easy data exchange between different protocols and systems.



PLC Automation product family

PLC Automation website – online tools

The www.abb.com/plc website is a mine of information on our products and documentation.

The screenshot displays the ABB PLC Automation website interface. At the top left is the ABB logo and navigation menu (HOME, OFFERINGS, PLC AUTOMATION). The top right features a 'GLOBAL SITE' dropdown, a 'LOG IN' button with a user icon, and links for 'Partners' and 'ABB'. A language selector indicates the current page is in English (EN), with other options like DE, IT, ES, PL, SV, FI, ZH, and JA. Social media icons for YouTube and Twitter are also present.

The main heading is 'PLC Automation', followed by a descriptive paragraph: 'ABB's automation devices deliver solutions with high performance and flexibility to be effectively deployed within diverse industries and applications including water, building infrastructure, data centers, renewable energy, machinery automation, material handling, marine and more.'

A call to action asks, 'Are you looking for support or purchase information?' with a 'Contact us' link.

The 'Our offering' section features five numbered items:

- 01 Programmable Logic Controllers PLCs (image of PLC rack)
- 02 Automation Builder (image of computer monitor)
- 03 ABB zenon (image of computer monitor)
- 04 Control panels (image of various control panels)
- 05 Legacy products (image of PLC units)

The 'Highlights' section (06) contains ten featured articles with images and titles:

- 01 Safer, greener and more productive with AC500-S safety PLC
- 02 AC500 PLC Automation for infrastructure
- 03 AC500-S safety PLC facilitates use of fail-safe condition monitoring
- 04 Distribution center using AC500 with new safety CPUs
- 05 Embedding safety I/Os in ABB robots enhances man-machine collaboration
- 06 PLC Automation main catalog pdf
- 07 AC500 PLC & Renewable Energy Generation
- 08 ABB sponsors Control & Motion Laboratory
- 09 Predictive Performance with AC500 Condition Monitoring CMS
- 10 More PLC stories, articles and videos

The 'Popular links' section (07) includes:

- Main catalog flipbook
- Industry solutions
- Documents & Downloads
- Training & support
- Partner network
- Spare parts

The 'Related products' section (08) lists:

- Drives
- Motion control
- Robotics
- Distributed control systems
- Safety solutions

09

Contact us

Submit your inquiry and we will contact you

[CONTACT US](#)

Find a channel partner

Quickly find an ABB channel partner

[FIND A CHANNEL PARTNER](#)

Or contact your [ABB Contact Center](#)

01 – Programmable Logic Controllers PLCs

- AC500-eCo (CPUs, S500-eCo I/O modules, Accessories)
- AC500 (CPUs, Communication modules, Communication interface modules, S500 I/O modules, Accessories, Condition Monitoring CMS)
- AC500-XC (CPUs, Communication modules, Communication interface modules, S500 I/O modules, Accessories, Condition Monitoring CMS)
- AC500-S (CPUs, S500 I/O modules)

02 – Automation Builder engineering suite

- Download link
www.abb.com/automationbuilder

03 – ABB zenon**04 – Control panels**

- CP600-eCo (Devices, Software, Accessories)
- CP600 (Devices, Software, Accessories)
- CP600-Pro (Devices, Software, Accessories)

05 – Legacy products

- AC31 and previous series
- CP400
- CP500
- DigiVis 500
- Wireless products

06 – Highlights

- Articles, videos, product news, success stories and more

07 – Popular links

- Main catalog
- Industry solutions
- Documents & Downloads
- Training & support
- Partner network
- Spare parts

08 – Related products

- Drives
- Motion control
- Robotics
- Distributed control systems
- Safety solutions

09 – Contact information for your country

Please watch our videos on our ABB PLC YouTube channel:



www.youtube.com/user/abbplc

Automation Builder

Integrated engineering suite

051	Key features
052–053	Ordering data
054–055	Software features
056–057	Library features
058–059	Runtime license features
060	Productivity features
061	Virtual Commissioning Platform – advanced simulation support

Automation Builder

Key features



—
• Stay in control of your project: Automation Builder integrates engineering tools for PLCs, safety, drives, motion, control panels and SCADA

—
• Reduce risk: Manage complexity and realize connectivity easily

—
• Increase efficiency: Build comprehensive solutions with integrated engineering that add value to your business

—
• Combine tools: One common intuitive interface for configuring, programming, debugging and maintaining automation projects

—
• Save time: Test systems effortlessly in virtual time without real hardware using Virtual Commissioning technology

Automation Builder

Ordering data

Automation Builder

- Automation Builder connects the engineering tools for PLC, safety, drives, motion, control panels and SCADA. The software suite integrates products into solutions that create value for your customers, giving you greater control of your projects, reducing risk and saving time.
- Open systems win. They lead to more innovation, value and freedom of choice for your business. Automation Builder enables you to adapt the tool chain to your needs and workflows. The software is open for your specific product and communication technology to build your distinct solution.
- Automation Builder provides advanced features, further increasing engineering productivity for your automation solutions.
- Freemium license model with high flexibility in using the licenses. Licenses can be activated on PCs, USB license dongles or license servers (including borrowing of licenses for offline use).
- For details please refer to Automation Builder – Software Features.

Automation Builder Editions

For	Description	Type	Order code
Free 61131-3 engineering for simple PLC solutions	Automation Builder 2.x Basic (1)	-	-
Integrated Engineering for PLC, drives, motion, SCADA, panels	Automation Builder 2.x Standard (2)	DM200-TOOL	1SAS010000R0102
	Automation Builder 2.x Standard Upgrade (2)(3)	DM201-TOOL-UPGR	1SAS010001R0102
	Automation Builder 2.x Standard Network (5)	DM204-TOOL-NW	1SAS010004R0102
Integrated Engineering for PLC, drives, motion, SCADA, panels and features for engineering productivity and collaboration	Automation Builder 2.x Premium (5)	DM202-PREM	1SAS010002R0102
	Automation Builder 2.x Premium Upgrade (4)(5)	DM203-PREM-UPGR	1SAS010003R0102

Automation Builder add-ons

Functional safety engineering	AC500-S Safety PLC programming	DM220-FSE (2) DM221-FSE-NW (5)	1SAS010020R0102 1SAS010021R0102
Collaborative engineering support	Professional Version Control with Subversion for Automation Builder 2.x	DM207-PVC (2) DM214-PVC-NW (5)	1SAS010007R0102 1SAS010014R0102
Static code analysis	Professional Static Analysis for Automation Builder 2.x (6)	DM210-PSA (2) DM217-PSA-NW (5)	1SAS010010R0102 1SAS010017R0102
Optimization of runtime performance	Professional Profiler for Automation Builder 2.x (6)	DM211-PPR (2) DM218-PPR-NW (5)	1SAS010011R0102 1SAS010018R0102
Advanced simulation support	Virtual Commissioning Platform for Automation Builder 2.x (7)	DM250-VCP (2) DM251-VCP-NW (5)	1SAS010050R0102 1SAS010051R0102

Accessories

Automation Builder licensing based on a USB Key	USB Key for Automation Builder without license (8)	DM-KEY	1SAP193600R0001
---	--	--------	-----------------

All Automation Builder PC software licenses can be installed either on engineering PCs or on USB dongles. Network licenses can also be installed on a license server. The licenses can be transferred between computers or dongles unlimited times.

(1) Free license

(2) Single user license - bound to PC or DM-KEY (USB Key)

(3) Purchase this option to upgrade Automation Builder 1.x Standard to Automation Builder 2.x Standard

(4) Purchase this option to upgrade Automation Builder 1.x Premium to Automation Builder 2.x Premium. Edition upgrade licenses from Automation Builder 2.x Standard to Automation Builder 2.x Premium are available on demand.

(5) Network license for shared usage within a local area network or for usage on Windows Server operating systems. Per license one user can use the license at the same time. Network licenses that can be borrowed for offline use are available on request.

(6) In preparation

(7) Expert function - only available on request

(8) Does not contain license. Automation Builder license must be purchased separately. Can carry an arbitrary number of licenses.



Automation Builder

Automation Builder

Ordering data

AC500 Library Licenses

For	Description	Type	Order code
all AC500 V2 CPUs	Solar library	PS562-SOLAR	1SAP195000R0101
all AC500 V2 CPUs	Water library	PS563-WATER	1SAS030000R0101
all AC500 V2 CPUs	Motion Control library, Extended	PS552-MC-E	1SAP192100R0102
all AC500 V2 CPUs	Temperature control library	PS564-TEMPCTRL	1SAS030010R0101
all AC500 V2 CPUs	BACnet library B-ASC profile	PS565-BACnet-ASC	1SAP195500R0101

Delivery includes a single user license, which can be used for creating applications for an unlimited number of CPUs. All library licenses can be installed on engineering PCs, on USB dongles or on Windows Server operating systems. The licenses can be transferred between computers or dongles unlimited times.

AC500 Runtime Licenses

For	Description	Type	Order code
all AC500 CPUs	Modbus TCP HA runtime license	PS5601-HA-MTCP	1SAP195400R0101
all AC500 V3 CPUs	IEC 61850 protocol runtime license	PS5602-61850	1SAP195600R0101
all AC500 V3 CPUs	KNX IP protocol runtime license	PS5604-KNX	1SAP195800R0101
all AC500 V3 CPUs	BACnet protocol B-BC; runtime license (1)	PS5607-BACnet-BC	1SAP195550R0101

For using runtime licensed features one license per CPU is required. The license has to be installed on the AC500 V3 CPU either by connecting it to Automation Builder or via SD card that has been prepared by Automation Builder for license activation.

The licenses can be transferred between AC500 V3 CPUs unlimited times.

(1) In preparation

Further application libraries and examples:

Please check and download further libraries and examples from: www.abb.com/plc

Use English language setting, then click on “Application Examples”.

Application Examples explain functionality by using e.g. standard Automation Builder libraries and functions in simple examples. They are tested in the described example configuration and functionality only, they come with documentation and are free of charge.

Applications Examples help to minimize valuable programming and testing time for specific applications.



AC500 libraries

Automation Builder

Software features

Automation Builder		Basic	Standard	Premium
Features and target hardware		Basic system engineering FREE	Integrated system engineering	Productivity and collaboration
Productive engineering	Integrated engineering for PLCs, safety, robots, motion, drives, SCADA and control panels	○	●	●
	Integrated tool suite installation and maintenance (online and offline)	●	●	●
	Project handling including project archive and backup features	●	●	●
	Project lifecycle support (version profiles and project migration)	●	●	●
	Native language support in EN, DE, ES, FR, CN	●	●	●
	Support of standardization and re-use by flexible configurations of machine variants and advanced IO device handling	●	●	●
	Support of re-use by cross project and cross Automation Builder instance copy&paste	●	●	●
	ECAD roundtrip engineering - AC500 and EPLAN / Zuken E3			●
	ECAD roundtrip engineering for 3rd party devices - PLC and EPLAN / Zuken E3			●
	Bulk data import/export with change control to any tool via CSV (also via copy&paste)			●
	Bulk data import/export of device and I/O lists and IEC 60870-5-104			●
	Change management support by project compare			●
	Automation of engineering (execution of Python scripts)			●
	Virtual system testing based on Virtual Commissioning Technology		○	○
Collaborative engineering support by Professional Version Control with Subversion		○	○	
PLC engineering (AC500 V2)	For: AC500-eCo, AC500 V2, AC500-XC, AC500-S Safety, AC500 local I/O modules, AC500 extension modules			
	PLC application programming (IL, LD, FBD, SFC, ST) plus CFC	●	●	●
	PLC firmware update, download and online change to single or several PLCs	●	●	●
	PLC simulation, diagnosis and debugging	●	●	●
	Integrated firmware identification and update (PM and CM devices)	●	●	●
	Configuration of communication protocols for TCP/IP, Modbus, CS31, IEC60870-5-104	●	●	●
	Configuration of communication protocols for PROFINET, EtherCAT, PROFIBUS DP, CAN (all via coupler)		●	●
	C/ C++ application programming (GNU compiler)			●
Virtual system testing based on Virtual Commissioning Technology		○	○	
PLC engineering (AC500 V3)	For: AC500 V3 and supported AC500 local I/O modules and AC500 extension modules			
	PLC application programming (LD, FBD, SFC, ST) plus CFC	●	●	●
	PLC firmware update, download and online change to single PLC	●	●	●
	PLC diagnosis and debugging	●	●	●
	Integrated firmware identification and update (PM and CM devices)	●	●	●
	Configuration of communication protocols for TCP/IP, Modbus TCP, Modbus RTU, IEC60870-5-104, CAN, BACnet, KNX	●	●	●
	Configuration of communication protocols for PROFINET, EtherCAT, CAN (all via coupler)		●	●
Virtual system testing including PLCs based on Virtual Commissioning Technology (in preparation)		○	○	
Safety PLC engineering (integrated solutions)	For: AC500-S Safety CPU, Safety I/Os and PROFIsafe devices			
	Safety PLC application programming (LD, FBD, ST)		○	○
	Fieldbus protocol engineering for PROFIsafe		○	○
Safety PLC engineering (stand-alone solutions)	For: Pluto Safety PLC			
Safety Engineering with Pluto Manager	○	○	○	
SCADA engineering	For: ABB zenon			
Integrated SCADA and PLC engineering with ABB zenon Editor		○	○	

Automation Builder

Software features

Automation Builder		Basic	Standard	Premium
Features and target hardware		Basic system engineering FREE	Integrated system engineering	Productivity and collaboration
Control Panel engineering	For: CP600, CP600-Pro, CP600-eCo, CP600-WEB, PB610-R			
	CP600 , CP600 2 nd generation and CP600-Pro panel configuration with PB610 Panel Builder 600	○	●	●
	CP600-eCo panel configuration with PB610 Panel Builder 600	●	●	●
	PLC tag data import	●	●	●
	Control Panel simulation for Virtual Commissioning Technology	●	●	●
Drive engineering	For: ACS355, ACS380, ACS480, ACS550, ACS580, ACS850, ACQ810, ACS880, DCS880, ACSM1			
	Drive management, configuration and diagnosis with common process data editor (Drive - PLC)		●	●
	Drive engineering in Drive composer pro	○	●	●
	Virtual system testing including Drives based on Virtual Commissioning Technology (only for ACS880)		○	○
Motion engineering	For: MicroFlex e150, Motiflex e180, Motiflex e190			
	Motion application engineering with Mint WorkBench	●	●	●
	PLC tag data import	●	●	●
Modbus TCP engineering	For: CI521-MODTCP, CI522-MODTCP			
	Configuration and diagnosis of unbundled Modbus TCP CI (communication interface) devices	●	●	●
Solution engineering	Drive library	●	●	●
	MQTT and JSON libraries	●	●	●
	Motion Control for AC500 V2 PLCopen Motion library (PS552-MC-E)	○	○	○
	Solar library (PS562-SOLAR)	○	○	○
	Water library (PS563-WATER)	○	○	○
	Temperature Control library (PS564)	○	○	○
	BACnet – ASC library (PS565) V2; - BC profile (PS5607) f. V3	○	○	○
	AC500 High Availability HA-CS31 library		●	●
	AC500 High Availability HA-Modbus TCP library V2/V3 (1)		○	○
	KNX-protocol V3 (1)		○	○
	IEC61850 for AC500 V3 (1)		○	○
	PackML library (*)		●	●
	FTP client library (PS554) (*)		●	●
	Signal Processing Package (*)		●	●
Pumping library (PS571) (*)		●	●	
HVAC library (*)		●	●	
Process control objects (PCO) library (*)	●	●	●	
Further features	PLC Multidownload tool for large installations		●	●
	OPC server and clients, service tool, PLC gateway, IP configuration and visualization		●	●
Operating systems	Recommended: Windows 7 32/64-bit, Windows 8.1 32/64-bit, Windows 10 32/64-bit (2)	●	●	●
PC requirements	Minimum: 1 GHz, 3 GB RAM, 14 GB free disk space	●	●	●

● included

○ optional (additional license required) as integrated tool / feature / library

○ optional (additional license required) as standalone tool / feature - not integrated in Automation Builder

(1) additional runtime license per PLC required

(2) Limited support for Windows server operating systems - please check release notes for further information

(*) Technology Preview: Technology Previews are non-final versions of our product and should not be taken as a measure of the fit, finish, capability, and overall quality of the product. While we don't stop using these versions in projects, we don't recommend it if data loss and the usual quirks of preview software cannot be afforded.

Automation Builder

Library features



PS562-SOLAR

Solar tracker solution library

Library for solar tracking applications enabling fast engineering, especially together with ABB's drives and motors

Covers different tracker configurations and different algorithms for accuracy needs

- Control of trackers in parabolic trough, power tower, PV and CPV applications.

Complete library package for different tracking use cases, plug and play:

Example program with detailed explanations and visualizations

- Control of the tracker adaptable to different needs and conditions, to achieve maximum efficiency of installation
- Exact positioning of different axes with the following accuracies:
 - NOAA algorithm 0.03 Grad
 - NREL algorithm 0.0003 Grad.
- Input / sensor adaptation
- Communication
- Different actuators / drives control
- All needed modes for simple commissioning and manual operation:
 - Fast and simple calibration of the trackers, offering manual repositioning and fine tuning
 - Safety positions
 - Back tracking.



PS563-WATER

Water solution library

Library supporting the most common functions in many water applications

Flexible data logging options:

- Especially suited for remote communication like GSM/GPRS
- Timestamp in logging
- Integrated variants for simple use with IEC 60870-5-104
- Logging to files: storage capacity only dependent on memory availability
- Flexible log conditions (cyclic, event or tolerance based).

Support for pumping station functions with different operation modes

- Standard multidrive functions (PLC based)
- Advanced functionality together with ABB ACS and ACQ810 drives
- Detailed diagnosis
- Energy efficiency functions
- Multidrive functions
- Flow estimation.

Control Panel CP600 support for ACQ810: Fast and simple configuration for pumping stations with reduced programming effort via pre-built visualization screen templates.

Application examples for fast engineering and startup.



PS564-TEMPCTRL

Temperature control library

Library packet for advanced temperature control applications

Includes extended, flexible PID functionality with Auto-tune for temperature control

- Enhanced response time and reduced overshoots and oscillations
- Option to optimize control for very different heating and cooling characteristics.
- Enhanced tolerance to thermocouple input noise
- Normal and standby- setpoints
- Multi-level temperature monitoring and alarms provides flexible operation and protection for machine and process
- Logging enables complete overview of the actual situation and past behavior
- Configurable output timing, synchronization for peak load shaving in multi-zone setups
- Simulation blocks enable off-line setup and pre-test of a new project
- Group-programming

Example projects, including adaptable HMI project for CP600 family, well suited for multi zone and grouped temperature control e.g. in Extrusion:

- Easy to use operator interface
- Provides quick access to setup, monitoring and tuning screens for multiple zones
- Easily expandable to a large number of zones
- Zones: heat-, cool-only or heat-and-cool

License Package (Software is part of Automation Builder)

All AC500 V2 CPUs
NOAA: PM554-XX and above
NREL: PM573-ETH and above.

All AC500 V2 CPUs
Logging: PM573 and above.

All AC500 V2 CPUs.

Automation Builder

Library features



PS552-MC-E

Motion control library

Library enabling fast and standardized engineering according to PLCopen standard when using ABB's AC500 PLC for motion control, especially together with ABB's motion control Drives.

Covers different motion control options for single and multi-axis motion control applications:

- Drive-Based and PLC-Based motion
- In PLC based motion, the position control loop could be closed in the PLC or drive (with synchronized network)
- Single axis, multi-axis and coordinated motion
- Defined Jerk limitation by polynomial interpolation
- Spline interpolation or polynomial interpolation for cam curves, position velocity or acceleration profiles available
- Possible to switch over between different movements and cam curves directly
- Latch functionality by utilizing fast drive inputs for ACS350, ACS800, ACSM1
- Drive based motion: commands from PLC, drives perform interpolation and control loop
- Supports the new Pulse Train Output module FM562.

PLCopen functions:

- Administrative Function Blocks
- Single axis Function Blocks
- Multiple axis Function Blocks
- Homing Function Blocks
- Coordinated Motion Function Blocks
- Additional ABB specific Function Blocks for further simplification.

PS565-BACnet-ASC

BACnet communication library

This library enables AC500 PLCs to connect OEM or infrastructure applications to BMS (Building Management Systems) or other controllers.

The PS565-BACnet-ASC library enables AC500 to serve as BACnet server device, complying with the B-ASC Device Profile and interfacing control requirements, and acting as hardwired or Modbus-to-BACnet gateway.

It supports BACnet IP (Ethernet) and BACnet MS/TP (serial) networks. The scalable AC500 platform is compatible with the BACnet library starting from eCo PM5x6 with larger memory (~ 300 objects) up to PM595 (more than 5000 objects).

The very transparent, object-oriented publish and subscribe approach of BACnet allows efficient and well-documented engineering and collaboration of many different parties in large infrastructure projects.

Highlights

- Easy-to-use BACnet communication directly in the CPU
- No coupler or gateways required
- Cost-efficient particularly for OEMs and projects
- Interfacing other non-BACnet devices to BMS.

PS565 for AC500 is BTL-approved and certified

PS573-PCO

Process control objects library

Facilitates the use of AC500 as controller in DCS solutions by providing function blocks for easy integration into the process visualization.

Twelve function blocks are available which cover the following functionalities:

- Digital and analog setpoints
- Analog measurement with threshold alarm functions
- Valve control
- Motor control with or without variable speed drives
- Proportional integral controller

The function blocks have an internal interface to the DCS system. Status and control are exchanged with the DCS system via OPC DA. For ABB Ability™ System 800xA an optional object library is available which contains symbols and faceplates that match the function blocks.

License Package (Software is part of Automation Builder)

All AC500 V2 CPUs (options and no. of blocks/ functions and performance will depend on CPU size and memory).

All AC500 V2 CPUs, starting from PM5x6 (~300 objects) up to PM595 (>5000 objects)

(No license required)

All AC500 V2 CPUs have an onboard Ethernet interface (number of function blocks and performance will depend on the CPU size and memory).

Automation Builder

Runtime license features

02



PS5601-HA-MTCP

High availability library using Ethernet (Modbus TCP)

Runtime license per CPU to download library into the CPU.

Same philosophy as proven serial/CS31 based library.

Enables hot-standby redundancy and bumpless transfer with standard AC500 CPUs.

Supports 3 redundancy levels:

- CPU
- I/O communication
- SCADA communication

Library package containing libraries based on Modbus TCP for field communication and using CI52x communication interface modules as I/O clusters with redundant connection.

Ethernet redundancy based on externally managed switches: Ethernet network can be independent of the redundancy mechanism used.

- Daisy chain in ring configuration of CI52x with MRP as redundancy protocol
- Fast reaction and switchover nearly independent of the number of clusters
- Possibility of integrating other devices e.g. ABB drives into the redundancy scheme.

Scalable redundancy, where CPUs can also be placed far away from each other (...kilometers if fiber-optic networks are used).

Includes the AC500 Bulk Data Manager as a tool for efficient configuration and cluster engineering.

- Configuration and export of projects, clusters, modules/parameters, signal names, visualization ("code generation")

Application examples for fast engineering and startup.

PS5602-61850

IEC 61850 MMS server and GOOSE communication

This runtime license enables the AC500 V3 PLC to connect to substation type equipment (IEDs) or act as IED.

The protocol library and configuration tool are part of Automation Builder. The runtime license is needed for download.

61850 server edition 1 allows:

- sending MMS messages to ensure a safe data communication – no real time support
- publishing and subscribing to GOOSE messages for high priority peer-to-peer data exchange between different servers to ensure a data transmission with minimal delay
- up to 5 client connections per server
- up to 50 entries per dataset
- up to 20 datasets

Automation Builder used as IED configuration tool

- Import / export of SCL files formats
- ICD – IED capability description file
- SCD – substation configuration description file
- CID – configured IED description file

Basic display options

Highlights

- Wide set of Logical Nodes provided
- Further Logical Nodes can be defined
- Implementation can be programmed freely in IEC61131.

PS5604-KNX

KNX IP communication

This runtime license enables the AC500 V3 PLC to connect to KNX IP.

The protocol and configuration options are part of Automation Builder and FW. The runtime license is needed for download.

Support of

- Up to 1000 group objects
- Programming the physical address via ETS
- Downloading the KNX group address linking via ETS

Highlights

- Easy to use KNX communication directly in CPU due to tight ETS5 and Automation Builder integration via DCA
- No coupler or gateways needed
- Cost-efficient especially for OEMs and projects
- Enables holistic building automation solutions.

Runtime license (Software is part of Automation Builder)

All AC500 V2 and V3 CPUs

All AC500 V3 CPUs

All AC500 V3 CPUs

Automation Builder

Runtime license features



PS5607-BACnet-BC

BACnet communication

This runtime license enables the BACnet protocol on AC500 PLCs to connect OEM or infrastructure applications to BMS (Building Management Systems) or other controllers.

The PS5607-BACnet-BC license enables AC500 to act as BACnet server and client device, complying with the B-BC device profile.

It supports the use of BACnet IP (Ethernet) and BACnet MS/TP (serial) networks to be used with the scalable AC500 platform V3 CPUs.

The very transparent, object-oriented publish and subscribe approach of BACnet allows efficient and well-documented engineering and collaboration of many different parties in large infrastructure projects.

Highlights

- Comfortable configuration and editing in the Automation Builder with library support
- Easy-to-use BACnet communication directly in the CPU
- No coupler or gateways required
- Cost-efficient, particularly for OEMs and projects
- Interfacing other non-BACnet devices to BMS.

PS5607 for AC500 will be BTL-approved and certified.

Runtime license (Software is part of Automation Builder)

All AC500 V3 CPUs

Automation Builder

Productivity features

Object-oriented programming of AC500 V3 CPUs

All essential features of standard object-oriented programming are included in Automation Builder's object-oriented programming:

- Better structured program code with “separation of concerns” and information hiding
- Flexible extensibility by new types of objects (e.g. software representations of new types of drives)
- Reuse of code for defining specialized sub-classes (inheritance), reuse of code operating on different implementations of an interface (polymorphism)
- New optimized editors for IEC programming languages
- Continuous Function Chart (CFC) with auto routing of connections between POU's, unrestricted definition and display of the execution order
- Structured Text (ST) with Support for quick editing with common help, such as grouping, collapsible tree structure, and indented brackets

HMI integration

Synchronization of connection settings and access to tags on the AC500 PLC.

Drive integration

Seamless integration of ABB Drives connected to AC500 PLCs:

- Common configuration of cyclic data exchange
- Access to the drive via the AC500 PLC - no need for point-to-point connections
- Upload, download and offline editing of drive parameters

Integrated configuration of AC500 software features

All required AC500 software features can be selected and configured by Automation Builder, e.g.

- KNX gateway for connecting to building automation devices
- BACnet B-BC object engineering
- IEC 60870 protocol for data exchange with substations
- Time synchronization via SNTP
- Shared variables with other AC500 PLCs

Professional version control – management of the application project

Professional Version Control is an integrated link to the version control system Subversion (SVN). End users can use this tool to manage independently both the complete IEC 61131-3 project version, as well as the individual application objects. End users benefit from automated management of the source code when developing a project in various teams or over a long period of time.



Automation Builder

Virtual Commissioning Platform – advanced simulation support

Automation Builder 2.0 has introduced advanced simulation support which allows machine builders and system integrators to simulate and automate all kinds of applications with minimum effort. This gives seamless testing of the complete system at an early stage, even when all the necessary hardware is not yet ready. Even complex systems can be built up quickly and efficiently, ensuring smooth interaction of all the components.

Virtual Commissioning Technology lets you build simulation models from virtual devices and manage the virtual time and signal exchange between the virtual devices. Furthermore it provides interfaces to control and manipulate the simulation e.g. via OPC DA or via UDP communication.

Virtual devices emulate real hardware. They function as real hardware, provide signals (onboard, local, fieldbus/remote IOs) and variables. Virtual time lets you control the execution of the simulation. Speed up, slow down or freeze the execution for testing and debugging.

By connecting to external simulation tools (e.g. RobotStudio), additional components can be included to these models. This allows to simulate the real system including physical inputs or actuators. The flexible architecture of the Virtual Commissioning Technology allows to extend your simulation to more advanced aspects, e.g. the dynamic system behavior.



AC500-eCo

Entry level PLC solutions

065	Key features
066–069	Ordering data
070–077	Technical data
078–079	System data

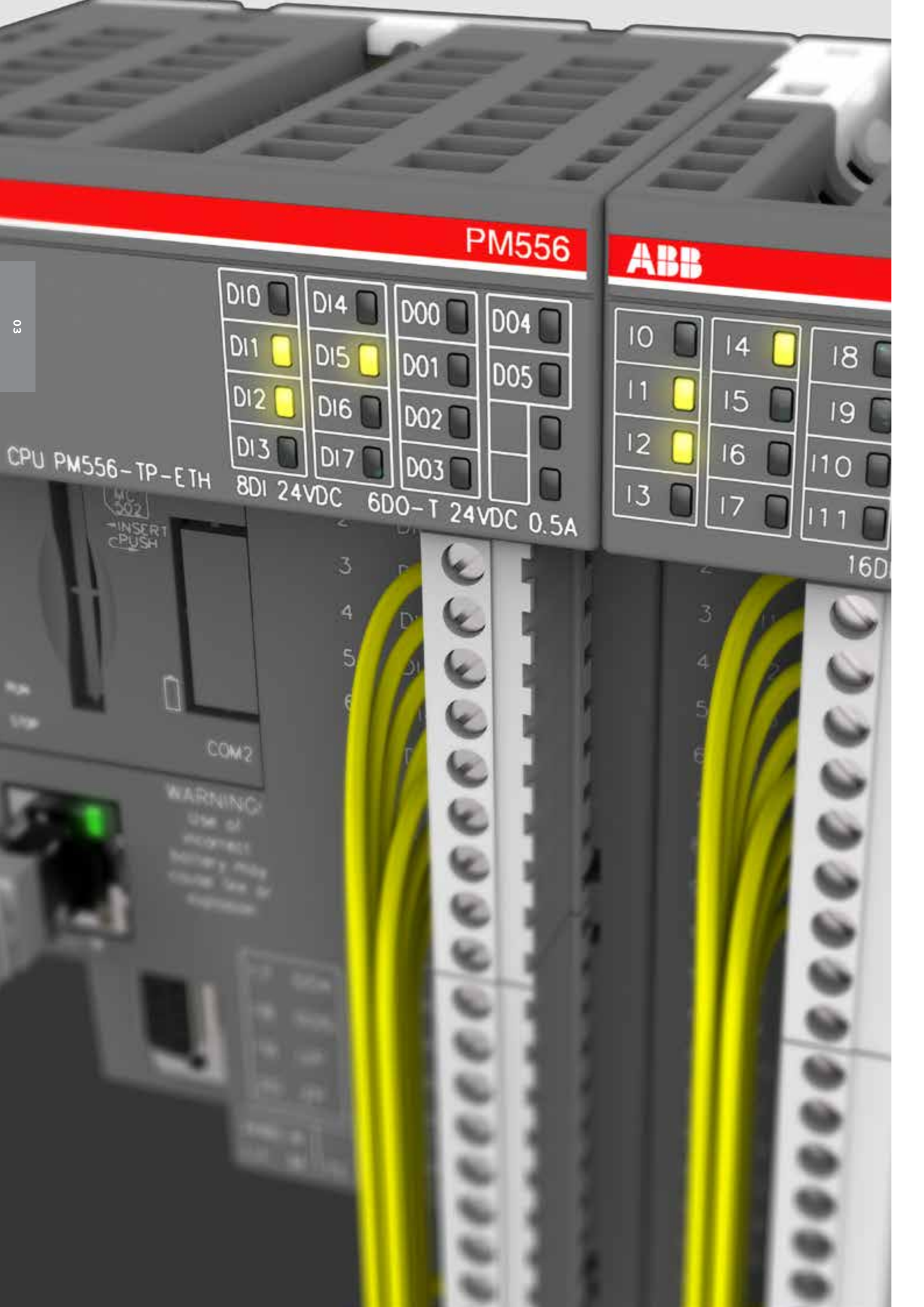

PM556

ABB

DI0	DI4	D00	D04
DI1	DI5	D01	D05
DI2	DI6	D02	
DI3	DI7	D03	

10	14	18
11	15	19
12	16	110
13	17	111

CPU PM556-TP-ETH 8DI 24VDC 6DO-T 24VDC 0.5A

MC 302
→ INSERT
→ PUSH
COM2

WARNING!
Use of
incorrect
battery may
cause fire or
explosion

AC500-eCo

Key features



• High performance variant with large memory available

- Up to 10 I/O modules connected to the CPU
- Compatible with all standard I/O modules (S500 and S500-eCo)
- Digital I/O module with configurable I/O available

- Three different types of terminal blocks available
- Integrated onboard I/O
- AC versions with integrated power supply

- Comprehensive communication options:
 - Ethernet for communication and web server for user defined visualization
 - Up to two serial ports for decentralized I/O and communication

AC500-eCo

Ordering data

AC500-eCo CPUs

- 1 RS485 serial interface (2nd is optional)
- Centrally expandable with up to 10 I/O modules (standard S500 and/or S500-eCo modules can be mixed)
- Optional SD card adapter for data storage and program backup
- Variants with integrated Ethernet (Ethernet includes web server)
- Minimum cycle time per instruction: Bit 0.08 μ s, Word 0.1 μ s, Float-point 1.2 μ s.

Program memory kB	Onboard I/Os DI/DO/AI/AO	Relay /Transistor outputs	Integrated communication	Power supply	Type	Order code	Price	Weight (1 pce) kg
PM554: digital I/Os								
128	8 / 6 / - / -	Transistor	-	24 V DC	PM554-TP	1SAP120600R0001		0.300
128	8 / 6 / - / -	Relay	-	24 V DC	PM554-RP	1SAP120700R0001		0.400
128	8 / 6 / - / -	Relay	-	100-240 V AC	PM554-RP-AC	1SAP120800R0001		0.400
128	8 / 6 / - / -	Transistor	Ethernet	24 V DC	PM554-TP-ETH	1SAP120600R0071		0.400
PM556: digital I/Os, 512 kB program memory								
512	8 / 6 / - / -	Transistor	Ethernet	24 V DC	PM556-TP-ETH	1SAP121200R0071		0.400
PM564: digital and analog I/Os (1)								
128	6 / 6 / 2 / 1	Transistor	-	24 V DC	PM564-TP	1SAP120900R0001		0.300
128	6 / 6 / 2 / 1	Relay	-	24 V DC	PM564-RP	1SAP121000R0001		0.400
128	6 / 6 / 2 / 1	Relay	-	100-240 V AC	PM564-RP-AC	1SAP121100R0001		0.400
128	6 / 6 / 2 / 1	Transistor	Ethernet	24 V DC	PM564-TP-ETH	1SAP120900R0071		0.300
128	6 / 6 / 2 / 1	Relay	Ethernet	24 V DC	PM564-RP-ETH	1SAP121000R0071		0.400
128	6 / 6 / 2 / 1	Relay	Ethernet	100-240 V AC	PM564-RP-ETH-AC	1SAP121100R0071		0.400
PM566: digital and analog I/Os, 512 kB program memory (1)								
512	6 / 6 / 2 / 1	Transistor	Ethernet	24 V DC	PM566-TP-ETH	1SAP121500R0071		0.400

Terminal blocks (9 and 11 poles) are necessary for each AC500-eCo I/O. The terminal blocks must be ordered separately.

(1) All analog inputs on PM564 and PM566 can be configured as digital inputs.



PM554
AC500-eCo CPU
with Ethernet



PM564
AC500-eCo CPU
without Ethernet

AC500-eCo

Ordering data

S500-eCo I/O modules

- For central expansion of the AC500 or AC500-eCo CPUs
- For decentralized expansion in combination with communication interface module DC551-CS31, CI52x-MODTCP, PROFINET CI50x modules, CI592-CS31, PROFIBUS modules CI54x, EtherCAT modules CI51x, and CANopen modules CI58x (not usable with DC505-FBP module and CI590-CS31-HA).

Digital I/O

- DC: Channels can be configured individually as inputs or outputs.

Number of	Input signal	Output type	Output signal	Terminal block required		Type	Order code	Price	Weight (1 pce) kg
				9 poles	11 poles				
DI/DO/DC									
8 / - / -	24 V DC	-	-	1	-	DI561	1TNE968902R2101		0.12
16 / - / -	24 V DC	-	-	1	1	DI562	1TNE968902R2102		0.12
8 / - / -	100-240 V AC	-	-	1	1	DI571	1TNE968902R2103		0.15
16 / - / -	100-240 V AC	-	-	1	1	DI572	1SAP230500R0000		0.19
- / 8 / -	-	Transistor	24 V DC, 0.5 A	-	1	DO561	1TNE968902R2201		0.12
- / 16 / -	-	Transistor	24 V DC, 0.5 A	1	1	DO562	1SAP230900R0000		0.16
- / 8 / -	-	Relay	24 V DC, 120 / 240 V AC, 2 A	-	1	DO571	1TNE968902R2202		0.15
- / 8 / -	-	Triac	100-240 V AC, 0.3 A	1	1	DO572	1TNE968902R2203		0.12
- / 16 / -	-	Relay	24 V DC, 120 / 240 V AC, 2 A	1	1	DO573	1SAP231300R0000		0.19
8 / 8 / -	24 V DC	Transistor	24 V DC, 0.5 A	1	1	DX561	1TNE968902R2301		0.12
8 / 8 / -	24 V DC	Relay	24 V DC, 120 / 240 V AC, 2 A	1	1	DX571	1TNE968902R2302		0.15
- / - / 16	24 V DC	Transistor	24 V DC, 0.5 A	1	1	DC562	1SAP231900R0000		0.15

Terminal blocks (9 or 11 poles) are necessary for each S500-eCo I/O. The terminal blocks must be ordered separately.

Analog I/O

- Each channel can be configured individually
- Resolution:
 - AI561, AO561, AX561: 12 bits/11 bits + sign
 - AI562, AI563: 15 bits + sign.

Number of	Input signal	Output signal	Terminal block required		Type	Order code	Price	Weight (1 pce) kg
			9 poles	11 poles				
AI/AO								
4 / 0	±2.5 V, ±5 V, 0...5 V, 0...10 V, 0...20 mA, 4...20 mA	-	1	1	AI561	1TNE968902R1101		0.12
2 / 0	PT100, PT1000, Ni100, Ni1000, Resistance: 150 Ω, 300 Ω	-	-	1	AI562	1TNE968902R1102		0.12
4 / 0	S, T, R, E, N, K, J, Voltage range: ±80 mV	-	1	1	AI563	1TNE968902R1103		0.12
0 / 2	-	-10...+10 V, 0...20 mA, 4...20 mA	-	1	AO561	1TNE968902R1201		0.12
4 / 2	±2.5 V, ±5 V, 0...5 V, 0...10 V, 0...20 mA, 4...20 mA	-10...+10 V, 0...20 mA, 4...20 mA	1	1	AX561	1TNE968902R1301		0.13

Terminal blocks (9 or 11 poles) are necessary for each S500-eCo I/O. The terminal blocks must be ordered separately.



DI561



AI562



AX561

AC500-eCo

Ordering data

Positioning module

- For central expansion of the AC500 or AC500-eCo CPUs
- For decentralized expansion in combination with communication interface modules CI50X-PNIO or CI54X-DP
- The FM562 module provides Pulse Train Outputs for 2 axes. Profile generator integrated.

Number of axis	Input signal	Output signal	Terminal block required		Type	Order code	Price	Weight (1 pce) kg
			9 poles	11 poles				
2	4 digital inputs 24 V (2 per axis)	4 pulse outputs RS422 (2 per axis)	1	1	FM562	1SAP233100R0001		0.15

Terminal blocks (9 or 11 poles) are necessary for each S500-eCo I/O. The terminal blocks must be ordered separately. Library PS552-MC-E is required for programming this module.



FM562

Accessories

Description	Type	Order code	Price	Weight (1 pce) kg
SD Memory Card 2 GB needs the MC503 option	MC502	1SAP180100R0001		0.020
SD Memory Card adapter	MC503	1TNE968901R0100		0.010
Programming cable USB => RS485 Sub-D, 3 m	TK503	1TNE968901R1100		0.400
Programming cable USB => RS485 Terminal block, 3 m	TK504	1TNE968901R2100		0.400
RS485 isolator, Sub-D 9 poles / Terminal 5 poles for COM1	TK506	1SAP186100R0001		0.080
Real time clock option board, battery CR2032 not included	TA561-RTC (1)	1SAP181400R0001		0.007
RS485 serial adapter COM2, pluggable screw terminal block included	TA562-RS	1TNE968901R4300		0.007
Combined real time clock option with RS485 serial adapter COM2, pluggable screw terminal block, included	TA562-RS-RTC (1)	1SAP181500R0001		0.012
Screw mounting accessory for AC500-eCo CPU and S500-eCo I/O modules (100 pieces per pack)	TA566	1TNE968901R3107		0.450
RS485 isolated serial adapter COM2, pluggable screw terminal block included	TA569-RS-ISO	1SAP186400R0001		0.030
Set of accessories: 6 x plastic cover for option slot, 6 x 5 pole terminal block, 6 x 5 pole screw terminal block for COM2 serial interface.	TA570	1TNE968901R3203		0.090
Digital input simulator for onboard I/O of CPU, 6 x switch, 24 V DC	TA571-SIM	1TNE968903R0203		0.040

(1) Standard battery CR 2032 has to be purchased separately.



TK506



TA561-RTC



TA562-RS
TA569-RS-ISO



TA562-RS-RTC



TA570

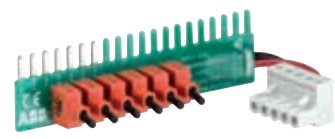

TA571-SIM

AC500-eCo

Ordering data

Terminal blocks for S500-eCo I/O modules and AC500-eCo CPUs

Number of poles	Connection type	Cable entry	Type	Order code	Price	Weight (1 pce) kg
9	Screw	Side	TA563-9	1TNE968901R3101		0.017
11	Screw	Side	TA563-11	1TNE968901R3102		0.020
9	Screw	Front	TA564-9	1TNE968901R3103		0.026
11	Screw	Front	TA564-11	1TNE968901R3104		0.035
9	Spring	Front	TA565-9	1TNE968901R3105		0.016
11	Spring	Front	TA565-11	1TNE968901R3106		0.020

 Only ABB terminal blocks must be used with AC500-eCo.
Package unit for these terminal blocks = 6.



TA563-9



TA564-11



TA565-9

AC500-eCo

Technical data

AC500-eCo CPUs

Type	PM554-TP	PM554-RP	PM554-RP-AC		PM554-TP-ETH	PM556-TP-ETH
Supply voltage	24 V DC		100-240 V AC		24 V DC	
Current consumption on	24 V DC		100 V AC	240 V AC	24 V DC	
Min. (module alone)	0.06 A	0.08 A	0.02 A	0.012 A	0.07 A	0.07 A
Max. (I/Os)	0.18 A	0.22 A	0.2 A	0.11 A	0.19 A	0.19 A
Program memory	128 kB					512 kB
Integrated data memory	14 kB thereof 2 kB saved					130 kB thereof 2 kB saved
Web server's data for user RAM disk	–				512 kB	1024 kB
Data buffering (of saved data)	flash memory					
Real-time clock (option with battery back-up) (1)	●					
Program execution						
Cyclical	●					
Time controlled	●					
Multi tasking	no, 1 task + 1 interrupt task max.					
Interruption	●					
User program protection by password	●					
Cycle time for 1 instruction (minimum)						
Binary	0.08 μs					
Word	0.1 μs					
Floating	1.2 μs					
Onboard digital inputs						
Channels	8 (including 2 counter inputs, or up to 4 interrupt inputs)					
Signal voltage	24 V DC					
Onboard digital outputs						
Channels	6 (including 2 PWM outputs for types with transistor outputs)					
Relay / Transistor	Transistor	Relay	Relay	Relay	Transistor	Transistor
Rated voltage	24 V DC	240 V AC	240 V AC	240 V AC	24 V DC	24 V DC
Nominal current per channel	0.5 A	2 A resistive	2 A resistive	2 A resistive	0.5 A	0.5 A
Onboard analog outputs						
Channels	-					
signal ranges	-					
Onboard analog inputs						
Channels	-					
signal ranges	-					
Max. number of centralized inputs/outputs						
Max. number of extension modules on I/O bus	up to max. 10 (S500 and/or S500-eCo modules allowed)					
Digital	inputs	320 + 8				
	outputs	320 + 6				
Analog	inputs	160				
	outputs	160				
Max. number of decentralized inputs/outputs						
On CS31 bus	up to 31 stations with up to 120 DI / 120 DO each or up to 32 AI/32 AO per station					
Internal interfaces						
COM1						
RS485	●					
Sub-D connection	●					
Programming, Modbus-RTU, ASCII, CS31	●					
COM2 (option) (2)						
RS485 / RS485 isolated	●/●					
Terminal block	●					
Programming, Modbus-RTU, ASCII	●					
Ethernet						
RJ45	–					●
Ethernet functions: Programming, Modbus TCP/IP, UDP/IP, integrated Web server, DHCP, FTP server, SNTTP client	–					●
SMTP	–					●
RUN/STOP switch	●					
LED for power, status and error	●					
Approvals	See detailed page 248 or www.abb.com/plc					

(1) Real-time clock requires optional TA561-RTC or TA562-RS-RTC.

(2) COM2 requires TA562-RS-RTC, TA562-RS or new TA569-RS-ISO.

AC500-eCo

Technical data

AC500-eCo CPUs

Type	PM564-TP	PM564-RP	PM564-RP-AC	
Supply voltage	24 V DC		100-240 V AC	
Current consumption on	24 V DC		100 V AC	240 V AC
Min. (module alone)	0.095 A	0.11 A	0.02 A	0.011 A
Max. (I/Os)	0.21 A	0.24 A	0.21 A	0.125 A
Program memory	128 kB			
Integrated data memory	14 kB thereof 2 kB saved			
Web server's data for user RAM disk				
Data buffering (of saved data)	flash memory			
Real-time clock (option with battery back-up) (1)	●			
Program execution				
Cyclical	●			
Time controlled	●			
Multi tasking	no, 1 task + 1 interrupt task max.			
Interruption	●			
User program protection by password	●			
Cycle time for 1 instruction (minimum)				
Binary	0.08 µs			
Word	0.1 µs			
Floating	1.2 µs			
Onboard digital inputs				
Channels	6 (including 2 counter inputs, or up to 4 interrupt inputs)			
Signal voltage	24 V DC			
Onboard digital outputs				
Channels	6 (including 2 PWM outputs for types with transistor outputs)			
Relay / Transistor	Transistor	Relay	Relay	
Rated voltage	24 V DC	240 V AC	240 V AC	
Nominal current per channel	0.5 A	2 A resistive	2 A resistive	
Onboard analog inputs				
Channels	2			
signal ranges	0...10 V / can be configured as digital input 24 V DC			
Onboard analog outputs				
Channels	1			
signal ranges	0...10 V / 0...20 mA / 4...20 mA			
Max. number of centralized inputs/outputs				
Max. number of extension modules on I/O bus	up to max. 10 (S500 and/or S500-eCo modules allowed)			
Digital	inputs	320 + 8		
	outputs	320 + 6		
Analog	inputs	160 + 2		
	outputs	160 + 1		
Max. number of decentralized inputs/outputs				
On CS31 bus	up to 31 stations with up to 120 DI / 120 DO each or up to 32 AI/32 AO per station			
Internal interfaces				
COM1				
RS485	●			
Sub-D connection	●			
Programming, Modbus-RTU, ASCII, CS31	●			
COM2 (option) (2)				
RS485 / RS485 isolated	●/●			
Terminal block	●			
Programming, Modbus-RTU, ASCII	●			
Ethernet				
RJ45	–			
Ethernet functions: Programming, Modbus TCP/IP, UDP/IP, integrated Web server, DHCP, FTP server, SNMP client	–			
SMTP	–			
RUN/STOP switch	●			
LED for power, status and error	●			
Approvals	See detailed page 248 or www.abb.com/plc			

(1) Real-time clock requires optional TA561-RTC or TA562-RS-RTC.

(2) COM2 requires TA562-RS-RTC, TA562-RS or new TA569-RS-ISO.

AC500-eCo

Technical data

AC500-eCo CPUs

Type	PM564-TP-ETH	PM566-TP-ETH	PM564-RP-ETH	PM564-RP-ETH-AC
Supply voltage	24 V DC			100-240 V AC
Current consumption on	24 V DC			100 V AC 240 V AC
Min. (module alone)	0.10 A	0.10 A	0.12 A	0.023 A 0.014 A
Max. (I/Os)	0.22 A	0.22 A	0.25 A	0.22 A 0.13 A
Program memory	128 kB	512 kB	128 kB	
Integrated data memory	14 kB thereof 2 kB saved	130 kB thereof 2 kB saved	14 kB thereof 2 kB saved	
Web server's data for user RAM disk	512 kB	1024 kB	512 kB	
Data buffering (of saved data)	flash memory			
Real-time clock (option with battery back-up) (1)	●			
Program execution				
Cyclical	●			
Time controlled	●			
Multi tasking	no, 1 task + 1 interrupt task max.			
Interruption	●			
User program protection by password	●			
Cycle time for 1 instruction (minimum)				
Binary	0.08 μs			
Word	0.1 μs			
Floating	1.2 μs			
Onboard digital inputs				
Channels	6 (including 2 counter inputs, or up to 4 interrupt inputs)			
Signal voltage	24 V DC			
Onboard digital outputs				
Channels	6 (including 2 PWM outputs for types with transistor outputs)			
Relay / Transistor	Transistor	Transistor	Relay	Relay
Rated voltage	24 V DC	24 V DC	240 V AC	240 V AC
Nominal current per channel	0.5 A	0.5 A	2 A resistive	2 A resistive
Onboard analog inputs				
Channels	2			
signal ranges	0...10 V / can be configured as digital input 24 V DC			
Onboard analog outputs				
Channels	1			
signal ranges	0...10 V / 0...20 mA / 4...20 mA			
Max. number of centralized inputs/outputs				
Max. number of extension modules on I/O bus	up to max. 10 (S500 and/or S500-eCo modules allowed)			
Digital	inputs	320 + 8		
	outputs	320 + 6		
Analog	inputs	160 + 2		
	outputs	160 + 1		
Max. number of decentralized inputs/outputs				
On CS31 bus	up to 31 stations with up to 120 DI / 120 DO each or up to 32 AI/32 AO per station			
Internal interfaces				
COM1				
RS485	●			
Sub-D connection	●			
Programming, Modbus-RTU, ASCII, CS31	●			
COM2 (option) (2)				
RS485 / RS485 isolated	●/●			
Terminal block	●			
Programming, Modbus-RTU, ASCII	●			
Ethernet				
RJ45	●			
Ethernet functions: Programming, Modbus TCP/IP, UDP/IP, integrated Web server, DHCP, FTP server, SNMP client	●			
SMTP	–	●	–	–
RUN/STOP switch	●			
LED for power, status and error	●			
Approvals	See detailed page 248 or www.abb.com/plc			

(1) Real-time clock requires optional TA561-RTC or TA562-RS-RTC.

(2) COM2 requires TA562-RS-RTC, TA562-RS or new TA569-RS-ISO.

AC500-eCo

Technical data

Digital S500-eCo I/O modules

Type	DI561	DI562	DI571	DI572	DO561	DO562
Supply voltage	–	–	–	–	24 V DC	24 V DC
Current consumption on UP						
Max. (without load current)	–	–	–	–	0.005 A	0.005 A
Number of channels per module						
Digital						
inputs	8	16	8 (AC)	16 (AC)	–	–
outputs	–	–	–	–	8	16
Configurable as Input or Output DC	–	–	–	–	–	–
Relay / Transistor	–	–	–	–	Transistor	Transistor
Additional configuration of channels as:						
Fast Counter	no				not applicable	
Digital inputs						
Input signal voltage	24 V DC	24 V DC	100-240 V AC	100-240 V AC	–	–
Input time delay	typically 4...8 ms	typically 4...8 ms	typically 15 ms / 30 ms	typically 15 ms / 30 ms	–	–
Input current per channel						
At Input voltage						
24 V DC	typically 5 mA	typically 5 mA	–	–	–	–
5 V DC	typically 1 mA	typically 1 mA	–	–	–	–
15 V DC	> 2.5 mA	> 2.5 mA	–	–	–	–
30 V DC	< 8 mA	< 8 mA	–	–	–	–
40 V AC	–	–	< 3 mA	< 3 mA	–	–
164 V AC	–	–	> 6 mA	> 6 mA	–	–
Output current						
Nominal current per channel	–	–	–	–	0.5 A	–
Maximum (total current of all channels)	–	–	–	–	4 A	8 A
Residual current at signal state 0	–	–	–	–	< 0.5 mA	–
Demagnetization when switching off inductive loads	–	–	–	–	must be provided externally	–
Switching frequency						
For resistive load	–	–	–	–	limited by CPU cycle time	–
For inductive load	–	–	–	–	max. 0.5 Hz	–
For lamp load	–	–	–	–	max. 11 Hz at max. 5 W	–
Short circuit / overload proofness	–	–	–	–	no	–
Overload indication (I > 0.7 A)	–	–	–	–	no	–
Output current limiting	–	–	–	–	no	–
Resistance against reverse feeding of 24 V signals	–	–	–	–	no	–
Contact rating						
For resistive load, max.	–	–	–	–	–	–
For inductive load, max.	–	–	–	–	–	–
For lamp load	–	–	–	–	–	–
Lifetime (switching cycles)						
Mechanical lifetime	–	–	–	–	–	–
Lifetime under load	–	–	–	–	–	–
Maximum cable length for connected process signals						
Cable						
shielded	500 m					
unshielded	300 m				150 m	
Potential isolation						
Per module	●	●	●	●	●	●
Between the channels						
input	–	per group of 8	●	per group of 8	–	–
output	–	–	–	–	–	–
Voltage supply for the module's logic	internal via I/O bus					
Fieldbus connection						
Suitable communication interface module	CI501-PNIO, CI502-PNIO, CI504-PNIO, CI506-PNIO, CI511-ETHCAT, CI512-ETHCAT, CI541-DP, CI542-DP, CI581-CN, CI582-CN, DC551-CS31, CI592-CS31, CI521-MODTCP, CI522-MODTCP					

AC500-eCo

Technical data

Digital S500-eCo I/O modules

Type	D0571	D0572	D0573
Supply voltage	24 V DC		
Current consumption on UP			
Max. (without load current)	0.050 A	–	0.050 A
Number of channels per module			
Digital			
inputs	–	–	–
outputs	8	8	16
Configurable as Input or Output DC	–	–	–
Relay / Transistor	Relay (n.o.)	Triac (AC)	Relay (n.o.)
Process voltage			
DC	24 V	–	–
Digital inputs			
Input signal voltage	–	–	–
Input time delay	–	–	–
Input current per channel			
At Input voltage			
24 V DC	–	–	–
5 V DC	–	–	–
15 V DC	–	–	–
30 V DC	–	–	–
Output current			
Nominal current per channel	2 A	0.3 A	2 A
Maximum (total current of all channels)	2 x 8 A	2.4 A	max 10 A per group (20 A per module)
Residual current at signal state 0	–	1.1 mA rms at 132 V AC and 1.8 mA rms at 264 V AC	–
Demagnetization when switching off inductive loads	must be performed externally		
Switching frequency			
For resistive load	1 Hz max.	10 Hz max.	1 Hz max.
For inductive load	–	–	–
For lamp load	1 Hz max.	10 Hz max.	1 Hz max.
Short circuit / overload proofness	no		
Overload indication (I > 0.7 A)	no		
Output current limiting	no		
Resistance against reverse feeding of 24 V signals	●	–	●
Output rating for different loads			
For resistive load, max.	2 A	0.3 A	2 A
For inductive load, max.	–	–	–
For lamp load	200 W at 230 V AC 30 W at 24 V DC	–	200 W at 230 V AC 30 W at 24 V DC
Lifetime (switching cycles)			
Mechanical lifetime	100 000	–	100 000
Lifetime under load	100 000 at rated load	–	100 000 at rated load
Maximum cable length for connected process signals			
Cable			
shielded	500 m		
unshielded	150 m		
Potential isolation			
Per module	between outputs and logic	●	between outputs and logic
Between the channels			
input	–	–	–
output	per group of 4	●	per group of 8
Voltage supply for the module's logic	internal via I/O bus		
Fieldbus connection			
Suitable communication interface module	CI501-PNIO, CI502-PNIO, CI504-PNIO, CI506-PNIO, CI511-ETHCAT, CI512-ETHCAT, CI541-DP, CI542-DP, CI581-CN, CI582-CN, DC551-CS31, CI592-CS31, CI521-MODTCP, CI522-MODTCP		

AC500-eCo

Technical data

Digital S500-eCo I/O modules

Type		DX561	DX571	DC562
Supply voltage		24 V DC		
Current consumption on UP				
Max. (without load current)		0.005 A	0.050 A	0.010 A
Number of channels per module				
Digital	inputs	8	8	–
	outputs	8	8	–
Configurable as Input or Output DC		–	–	16
Relays / Transistor		Transistor	Relay (n.o.)	Transistor
Process voltage				
DC		24 V	24 V	24 V
Digital inputs				
Input signal voltage		24 V DC	24 V DC	24 V DC
Input time delay		typically 4...8 ms		typically 8 ms
Input current per channel				
At Input voltage	24 V DC	typically 5 mA	typically 5 mA	typically 5 mA
	5 V DC	< 1 mA	< 1 mA	typically 1 mA
	15 V DC	> 2.5 mA	> 2.5 mA	> 2.5 mA
	30 V DC	< 6.5 mA	< 6.5 mA	< 8 mA
Output current				
Nominal current per channel		0.5 A	2 A	0.5 A
Maximum (total current of all channels)		4 A	2 x 8 A	8 A
Residual current at signal state 0		< 0.5 mA	–	< 0.5 mA
Demagnetization when switching off inductive loads		must be performed externally		
Switching frequency				
For resistive load		Limited by CPU cycle time	1Hz max.	Limited by CPU cycle time
For inductive load		0.5 Hz max.	–	0.5 Hz max.
For lamp load		11 Hz max. at max. 5 W	1 Hz max.	11 Hz max. at max. 5 W
Short circuit / overload proofness		no		
Overload indication (I > 0.7 A)		no		
Output current limiting		no		
Resistance against reverse feeding of 24 V signals		no	yes	no
Output rating for different loads				
For resistive load, max.		–	2 A	–
For inductive load, max.		–	–	–
For lamp load		–	200 W at 230 V AC 30 W at 24 V DC	–
Lifetime (switching cycles)				
Mechanical lifetime		–	100 000	–
Lifetime under load		–	100 000 at rated Load DC-13 according to IEC 60947-5-1	–
Maximum cable length for connected process signals				
Cable	shielded	500 m		
	unshielded	150 m		
Potential isolation				
Per module		●	–	●
Between the channels	input	–	per group of 8	–
	output	–	per group of 4	–
Voltage supply for the module's logic		internal via I/O bus		
Fieldbus connection				
Suitable communication interface module		CI501-PNIO, CI502-PNIO, CI504-PNIO, CI506-PNIO, CI511-ETHCAT, CI512-ETHCAT, CI541-DP, CI542-DP, CI581-CN, CI582-CN, DC551-CS31, CI592-CS31, CI521-MODTCP, CI522-MODTCP		

AC500-eCo

Technical data

Analog S500-eCo I/O modules

Type		AI561	AO561	AX561	AI562	AI563
Supply voltage		24 V DC				
Current consumption on UP						
Max. (without load current)		0.100 A	0.100 A	0.140 A	0.040 A	0.100 A
Number of channels per module						
Analog	inputs	4	–	4	2	4
	outputs	–	2	2	–	–
Inputs, individually configurable						
-2.5...+2.5 V	11 bits + sign	●	–	●	–	–
-5...+5 V	11 bits + sign	●	–	●	–	–
-10...+10 V	11 bits + sign	–	–	–	–	–
0...5 V	12 bits	●	–	●	–	–
0...10 V	12 bits	●	–	●	–	–
0...20 mA, 4...20 mA	12 bits	●	–	●	–	–
RTD		–	–	–	2	–
Pt100	-50...+400 °C (2/3-wire)	–	–	–	●	–
Pt1000	-50...+400 °C (2/3-wire)	–	–	–	●	–
Ni100 / Ni1000	-50...+150 °C (2/3-wire)	–	–	–	●	–
Resistor	0...150 Ω/0...300 Ω	–	–	–	●	–
Thermocouple	Types J, K, T, N, S, E, R	–	–	–	–	●
Voltage	-80...+80 mV	–	–	–	–	●
Resolution of temperature measurement 0.1°C		–	–	–	●	●
Outputs, individually configurable						
-10...+10 V	11 bits + sign	–	●	●	–	–
0...20 mA	12 bits	–	●	●	–	–
4...20 mA	12 bits	–	●	●	–	–
Potential isolation						
Per module		–	–	–	●	●
Fieldbus connection						
Suitable communication interface module		CI501-PNIO, CI502-PNIO, CI504-PNIO, CI506-PNIO, CI511-ETHCAT, CI512-ETHCAT, CI541-DP, CI542-DP, CI581-CN, CI582-CN, DC551-CS31, CI592-CS31, CI521-MODTCP, CI522-MODTCP				

AC500-eCo

Technical data

FM562 positioning module

The FM562 module contains Pulse Train Outputs for 2 axes. Profile generator for simple motion control tasks are integrated. The RS422 outputs allow a direct connection to Stepper- or Servo drives. Function blocks in PLCopen motion control style allow the integration of the module in an application. These function blocks are contained in the library PS552-MC-E.

Type	FM562	
Functionality		
Number of axis	2	
Digital inputs	2 digital inputs per axis Function: for axis enable or limit switch	
Pulse outputs	Modes cw/ccw or pulse/direction Built in profile generators	
Data of the digital inputs		
Signal voltage	24 V DC	
Input current at 24 V DC	typically 5 mA	
Potential isolation	by groups of 2	
Data of pulse outputs		
Signal	RS422 (differential)	
Frequency range	0...250 kHz	
Potential isolation	RS422 outputs of both axes in one group isolated against the inputs, the process voltage and the PLC CPU logic	
Maximum cable length for digital inputs		
Cable	shielded	500 m
	unshielded	300 m
Maximum cable length for pulse outputs		
Cable	shielded	300 m
	unshielded	30 m
Process voltage UP		
Nominal voltage	24 V DC	
Current consumption on UP	typically 0.04 A	
Reverse polarity protection	●	
Potential isolation		
Per module	●	
Voltage supply for the internal logic	From UP / ZP with isolation	
Fieldbus connection		
Suitable communication interface module	CI501-PNIO, CI502-PNIO, CI504-PNIO, CI506-PNIO, CI541-DP, CI542-DP	

AC500-eCo

System data

Environmental Conditions

Process and supply voltages

24 V DC	Voltage	24 V (-15 %, +20 %)
	Protection against reverse polarity	yes
100 V...240 V AC Wide Range Supply	Voltage	100...240 V (-15 %, +10 %)
	Frequency	50/60 Hz (-6 %, +4 %)
Allowed interruptions of power supply	DC supply	Interruption < 10 ms, time between 2 interruptions > 1 s, PS2
	AC supply	Interruption < 0.5 periods, time between 2 interruptions > 1 s

Important: Exceeding the maximum process and supply voltages could lead to unrecoverable damage of the system. The system could be destroyed. For the supply of the modules, power supply units according to PELV or SELV specifications must be used. The creepage distances and clearances meet the requirements of the overvoltage category II, pollution degree 2.

Assembly position

Horizontal	•
Vertical	•

Temperature

Operating	0 °C ... +60 °C	Preferred mounting position horizontal. Other mounting positions see manual.
Storage / Transport	-40 °C ... +70 °C	

Humidity

Operating / Storage	Max 95 % r. H. without condensation
---------------------	-------------------------------------

Air pressure

Operating	-1000 m ... 2000 m (1080 hPa ... 800 hPa)
Storage	<3500 m (>660 hPa)

Electromagnetic Compatibility

Radiated emission (radio disturbances)	Yes, in accordance with CISPR 16-2-3
Conducted emission (radio disturbances)	Yes, in accordance with CISPR 16-2-1, CISPR 16-1-2
Electrostatic discharge (ESD)	Yes, in accordance with IEC 61000-4-2, zone B, criterion B Electrostatic voltage in case of air discharge: 8 kV Electrostatic voltage in case of contact discharge: 6 kV
Fast transient interference voltages (burst)	Yes, in accordance with IEC 61000-4-4, zone B, criterion B Supply voltage units (DC): 2 kV Supply voltage units (AC): 2 kV Digital inputs/outputs (24 V DC): 1 kV Digital inputs/outputs (100...240 V AC): 2 kV Analog inputs/outputs: 1 kV Communication lines shielded: 1 kV I/O supply (DC-out): 1 kV
High energy transient interference voltages (surge)	Yes, in accordance with IEC 61000-4-5, zone B, criterion B Supply voltage units (DC): 1 kV CM* / 0.5 kV DM* Supply voltage units (AC): 2 kV CM* / 1 kV DM* Digital inputs/outputs (24 V DC): 1 kV CM* / 0.5 kV DM* Digital inputs/outputs (100...240 V AC): 2 kV CM* / 1 kV DM* Analog inputs/outputs: 1 kV CM* / 0.5 kV DM* Communication lines shielded: 1 kV CM* I/O supply (DC-out): 0.5 kV CM* / 0.5 kV DM* * CM = Common Mode, * DM = Differential Mode
Influence of radiated disturbances	Yes, in accordance with IEC 61000-4-3, zone B, criterion A Test field strength: 10 V/m
Influence of line-conducted interferences	Yes, in accordance with IEC 61000-4-6, zone B, criterion A Test voltage: 10 V
Influence of power frequency magnetic fields	Yes, in accordance with IEC 61000-4-8, zone B, criterion A 30 A/m 50 Hz 30 A/m 60 Hz

WARNING!

Risk of malfunctions and damages to persons!

Unused slots for communication modules are not protected against contact discharge. Dust and Dirt may cause contact problems and malfunctions.

I/O-Bus connectors must not be touched during operation.

In order to prevent malfunctions, it is recommended that the operating personnel discharge themselves prior to touching communication connectors or perform other suitable measures to reduce effects of electrostatic discharges.

AC500-eCo

System data

Environmental Conditions

Environmental Tests		
Storage		IEC 60068-2-1 Test Ab: cold withstand test -40 °C / 16 h
		IEC 60068-2-2 Test Bb: dry heat withstand test +70 °C / 16 h
Humidity		IEC 60068-2-30 Test Db: Cyclic (12 h / 12 h) Damp-Heat Test 55 °C, 93 % r. H. / 25 °C, 95 % r. H., 2 cycles
Vibration resistance		IEC 61131-2 / IEC 60068-2-6: 5 Hz ... 150 Hz, 1 g (with SD Memory Card inserted)
Shock resistance		IEC 60068-2-27: all 3 axes 15 g, 11 ms, half-sinusoidal
Mechanical Data		
Wiring method		Spring terminals / Screw terminals
Degree of protection		IP 20
Assembly on DIN rail	DIN rail type	According to IEC 60715
		35 mm, depth 7.5 mm or 15 mm
Assembly with screws	Screw diameter	4 mm
	Fastening torque	1.2 Nm

Main dimensions mm, inches

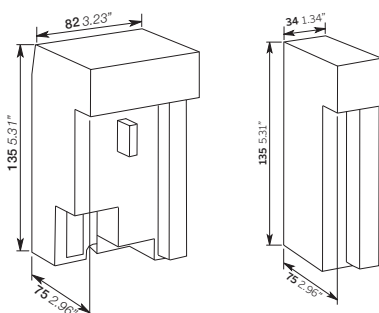

AC500

High performance
modular PLC

083	Key features
084–096	Ordering data
097–126	Technical data
127–128	System data

ABB

PM592

SYS
BATT
I/O-Bus

run

ETH
FBP
COM1
COM2

PWR



RUN



ERR



RUN

DIAG

VAL

CFG

ESC



OK



WARNING

Use of
incorrect
battery may
cause fire or
explosion.

MC
502

← INSERT
→ PUSH

UP 24VDC 10W

CPU

AC500

Key features



—

- A high performance PLC:
 - Large memory up to 160 MB
 - Highly modular
 - From 8 to +80 000 I/Os
 - More communication possibilities (Ethernet, Internet, PROFINET, PROFIBUS, Modbus, CANopen, EtherCAT, EthernetIP, OPC UA, OPC DA, IEC 60870-5-104, IEC61850, MQTT, ...)

—

- Common AC500 platform benefits: Automation Builder engineering suite, I/O modules, scalable and flexible

-
- Eight programming languages available (five IEC 61131-3, CFC, C-code and C++)
 - Object oriented engineering
 - Virtual controller
 - Webvisu
 - Data logging
 - SD card for program back-up
 - High Availability (HA) option
 - Screw or spring terminal for I/Os
 - Extensive programming libraries

AC500

Ordering data

AC500 CPUs

- 2 internal serial interfaces, RS232 / RS485 configurable
- Display and 8 function keys for diagnosis and status
- Centrally expandable with up to 10 I/O modules, 320 I/Os (S500 and/or S500-eCo modules allowed)
- Simultaneous operation of up to 4 external communication modules in any desired combination
- Optional SD card for data storage and program backup
- Can also be used as slave on PROFIBUS DP, CANopen or PROFINET IO using CM582-DP, CM588-CN, CM589-PNIO or CM589-PNIO-4 communication modules
- Ethernet version provides web server and IEC 60870-5-104 remote control protocol

Program memory kB	Cycle time in μ s per instruction min. Bit/Word/Float. point	Integrated communication	Type	Order code	Price	Weight (1 pce) kg
128	0.06 / 0.09 / 0.7	2 x serial	PM572	1SAP130200R0200		0.135
512	0.06 / 0.09 / 0.7	Ethernet (1), 2 x serial	PM573-ETH	1SAP130300R0271		0.150
512	0.05 / 0.06 / 0.5	2 x serial	PM582	1SAP140200R0201		0.135
1024	0.05 / 0.06 / 0.5	Ethernet (1), 2 x serial	PM583-ETH	1SAP140300R0271		0.150
1024	0.004 / 0.008 / 0.008	Ethernet (1), 2 x serial	PM585-ETH	1SAP140500R0271		0.150
2048	0.002 / 0.004 / 0.004	Ethernet (1), 2 x serial	PM590-ETH	1SAP150000R0271		0.150
2048	0.002 / 0.004 / 0.004	ARCNET BNC, 2 x serial	PM590-ARCNET	1SAP150000R0261		0.150
4096	0.002 / 0.004 / 0.004	Ethernet (1), 2 x serial	PM591-ETH	1SAP150100R0271		0.150
4096	0.002 / 0.004 / 0.004	2 x Ethernet (1), 1 x serial	PM591-2ETH (3)	1SAP150100R0277		0.150
4096	0.002 / 0.004 / 0.004	Ethernet (1), 2 x serial	PM592-ETH (2)	1SAP150200R0271		0.150

AC500 Machine controller kits

- Complete product bundle providing all the needed devices for a machine controller delivered under one single order code

Program memory kB	Cycle time in μ s per instruction min. Bit/Word/Float. point	Contents / Integrated communication	Type	Order code	Price	Weight (1 pce) kg
1024	0.004 / 0.008 / 0.008	PM585-ETH, CM579-ETHCAT, TB511-ETH Ethernet (1), 2 x serial, EtherCAT Master	PM585-MC-KIT	1SAP140500R0379		0.500
2048	0.002 / 0.004 / 0.004	PM590-ETH, CM579-ETHCAT, TB521-ETH, TA524 Ethernet (1), 2 x serial, EtherCAT Master	PM590-MC-KIT	1SAP150000R0379		0.500

(1) Provides integrated web server and IEC 60870-5-104 remote control protocol on each interface independently.

(2) Provides integrated 4 GB flashdisk for user data storage and data logging.

(3) Only to be used with dedicated terminal base TB523-2ETH.



PM572



PM592



PM585-MC-KIT

AC500

Ordering data

AC500 CPU PM595

- 2 Ethernet interfaces with integrated switch and software configurable protocol (PROFINET, EtherCAT or Ethernet e.g. Modbus TCP)
- 2 independent Ethernet interfaces for programming, online access, web server, Modbus TCP, IEC 60870-5-104 protocol e.g.
- 2 serial interfaces, RS232 / RS485 configurable
- Centrally expandable with up to 10 I/O modules (S500 and/or S500-eCo modules allowed)
- Simultaneous operation of up to 2 external communication modules in any desired combination, no need of additional terminal base

Program memory MB	Cycle time in μ s per instruction min. Bit/Word/Float. point	Integrated communication	Type	Order code	Price	Weight (1 pce) kg
16	0.0006/0.001/0.001	2 x Ethernet for Fieldbus (2 Ports switch), 2 x Ethernet (1), 2 x serial	PM595-4ETH-F (2)	1SAP155500R0279		1.050

(1) Provides integrated web server and IEC 60870-5-104 remote control protocol on each interface independently.

(2) Provides integrated 4 GB flashdisk for user data storage and data logging.



PM595-4ETH-F

AC500

Ordering data

Terminal base

- For mounting and connection of the CPUs and communication modules, not needed for PM595
- 1 to 4 plug-in communication modules
- Connection for communication coupler integrated in the CPU
- I/O interface for direct connection of up to 10 expansion modules
- Fieldbus-neutral FieldBusPlug-Slave interface not for TB523-2ETH
- Connection COM1: 9-pole pluggable terminal block
- Connection COM2: D-Sub 9 (not for TB523-2ETH).

Number of coupler slots	Connection for coupler integrated in the CPU	Type	Order code	Price	Weight (1 pce) kg
1	ARCNET BNC	TB511-ARCNET (2)	1SAP111100R0260		0.215
2	ARCNET BNC	TB521-ARCNET (2)	1SAP112100R0260		0.215
1	Ethernet RJ45	TB511-ETH	1SAP111100R0270		0.215
2	Ethernet RJ45	TB521-ETH	1SAP112100R0270		0.215
2	2x Ethernet RJ45	TB523-2ETH (1)	1SAP112300R0277		0.250
4	Ethernet RJ45	TB541-ETH	1SAP114100R0270		0.215

Note: These TBs are compatible with previous AC500 CPU versions (R01xx) and new ones (R02xx).

(1) Can only be used together the PM591-2ETH.

(2) Can be only used with PM590-ARCNET CPU.



TB511-ETH



TB541-ETH

AC500

Ordering data

AC500 Condition Monitoring CMS

- PLC integrated condition monitoring and fast protection for high frequency signals (vibration, current, voltage, speed/encoder)
- FM502-CMS module needs function module terminal base TF5x1 for direct interfacing to CPU, communication couplers, other I/O
 - for stand-alone or control/safety integrated condition monitoring
- PM592 CPU to be used on same TF5x1 for data storage and signal processing or communication
 - C-code interface for own complex diagnosis algorithms, 4GB Flash disk for raw fingerprints and indicator trending
- FM502-CMS module:
 - 16 fast, precise analog inputs, all synchronously sampled; configurable as IEPE or +-10V
 - individual measurement configuration (start,stop,trigger) per channel
 - per channel up to 50ksamples/s and 24bit ADC resolution, adjustable sampling
 - encoder inputs (5V or 24V) up to 300kHz counter; 12 modes, incl. absolute SSI (1MHz)
 - fast data logging, compact WAV-Files delivered automatically to CPU, incl. synchronized encoder signal if configured
 - analogue values always available for fast protection in I/O image of CPU
- Included in Automation Builder: Configuration, libraries for CMS control and wav file handling, examples
- Available download package: Signal processing library, example programs with simple diagnosis, logging and automated triggering (2)

Number of coupler slots	Description	Type	Order code	Price	Weight (1 pce) kg
n.a.	Function Module for Condition Monitoring Systems, 16AI, 2DI, 2DC, 1x Encoder (A, B, Z)	FM502-CMS	1SAP260400R0001		0.215
0	Function module terminal base for FM502, no coupler slots, 1x ETHERNET, 1x serial, spring terminals, 24 V DC	TF501-CMS (1)	1SAP117000R0271		0.350
2	Function module terminal base for FM502, 2x coupler slots, 1x ETHERNET, 1x serial, spring terminals, 24 V DC	TF521-CMS (1)	1SAP117200R0271		0.400

(1) Can only be used together with FM502 and PM592-ETH

(2) Download of Package under "Application Examples" at www.abb.com/plc



FM502-CMS



TF501-CMS



TF521-CMS

AC500

Ordering data

AC500 V3 CPUs

- 1x internal serial interface, RS232 / RS485 configurable (ACSII or Modbus RTU Master/Slave)
- 2x independant Ethernet interfaces which can also be used as switch and software configurable protocols like ModbusTCP, PROFINET IO Controller (2)(3), Ethernet IP Adapter (2)(3), EtherCAT Master (2)(3), IEC60870-5-104 or IEC61850 (3)
- Web server with WebVisu HTML5 Remove RTV for use with CP600 with Web interface
- 1x internal CAN interface, with CANopen Master/Slave (2), CAN 2A/2B and J1939 protocols
- Display and 8 function keys for diagnosis and status
- Centrally expandable with up to 10 I/O modules, 320 I/Os (S500 and/or S500-eCo modules allowed)
- Simultaneous operation of several external communication modules in any desired combination
- To be used exclusively with new TB56xx-2ETH
- Optional SD card for data storage and program backup
- To be used only with Automation Builder 2.x

Program and Data memory MB	Cycle time in μ s per instruction min. Bit/Word/Float. point	Integrated communication	Type	Order code	Price	Weight (1 pce) kg
8	0.020 / 0.020 / 0.120	2 x Ethernet with configurable protocols PROFINET IO Controller (2)(3) / EtherCAT Master (2)(3) or EthernetIP (2)(3), 1 x serial, 1x CAN interface	PM5630-2ETH (1) (4)	1SAP131000R0278		0.135
80	0.010 / 0.010 / 0.010	2 x Ethernet with configurable protocols PROFINET IO Controller (2)(3) / EtherCAT Master (2)(3) or EthernetIP (2)(3), 1 x serial, 1x CAN interface	PM5650-2ETH (1) (4)	1SAP141000R0278		0.135
160	0.002 / 0.002 / 0.002	2 x Ethernet with configurable protocols PROFINET IO Controller (2) / EtherCAT Master (2) or EthernetIP (2)(3), 1 x serial, 1x CAN interface	PM5670-2ETH (1) (4)	1SAP151000R0278		0.135
160 / 8GB Flash disk	0.002 / 0.002 / 0.002	2 x Ethernet with configurable protocols PROFINET IO Controller (2) / EtherCAT Master (2) or EthernetIP (2)(3), 1 x serial, 1x CAN interface	PM5675-2ETH (1) (4)	1SAP151500R0278		0.150

(1) Ethernet communication provides integrated web server, IEC 60870-5-104 remote control protocol and OPC UA Server on each interface independently.

(2) In preparation

(3) Some communication protocols are licensed see following lines

(4) Only to be used with dedicated terminal base TB56xx-2ETH



PM5630-2ETH



PM5650-2ETH



PM5670-2ETH



PM5675-2ETH

Feature licenses

Some HW or FW features need to be licensed to be used on the new CPU. Which allows:

- more flexibility
- better adaptation to the needs

License Type	CPU runtime license to be used on internal Ethernet interface	Type	Order code
HW	Modbus TCP HA runtime license	PS5601-HA-MTCP	1SAP195400R0101
HW	IEC 61850 protocol runtime license	PS5602-61850	1SAP195600R0101
HW	Runtime license for KNX controller	PS5604-KNX	1SAP195800R0101
HW	BACnet protocol B-BC; runtime license (1)	PS5607-BACnet-BC	1SAP195550R0101

(1) In preparation

AC500

Ordering data

AC500 V3 Terminal base

- For mounting and connection of the AC500 V3 CPUs only and communication modules
- 0, 1, 2, 4 or up to 6 (2) plug-in communication modules
- Connection for communication coupler integrated in the CPU
- I/O interface for direct connection of up to 10 expansion modules
- Connection COM1: 9-pole pluggable spring terminal block
- Connection CAN: 2x 5-pole pluggable spring terminal block
- 2x RJ45 Ethernet interfaces with configurable switch functionality

Number of coupler slots	Connection for coupler integrated in the CPU	Type	Order code	Price	Weight (1 pce) kg
0	2x RJ45 for Ethernet, 1x serial COM1 with pluggable spring connector and 1x2x5 poles pluggable spring connector for CAN/CANopen interface	TB5600-2ETH	1SAP110300R0278		0.165
1		TB5610-2ETH	1SAP111300R0278		0.190
2		TB5620-2ETH	1SAP112300R0278		0.215
4		TB5640-2ETH	1SAP114300R0278		0.265
6		TB5660-2ETH (2)	1SAP116300R0278		0.315

2) In preparation



TB5600-2ETH



TB5610-2ETH



TB5620-2ETH



TB5640-2ETH

AC500

Ordering data

Communication modules

Protocol	Connections	CPU V3 Support	Type	Order code	Price	Weight (1 pce) kg
PROFIBUS DP V0/V1 master	D-Sub 9	-	CM592-DP	1SAP173200R0001		0.115
PROFIBUS DP V0/V1 slave	D-Sub 9	-	CM582-DP	1SAP172200R0001		0.115
Ethernet (TCP/IP, UDP/IP, Modbus TCP)	2 x RJ45 - integrated switch	-	CM597-ETH	1SAP173700R0001		0.115
CANopen master	Terminal block 2 x 5 poles spring	(1)	CM598-CN	1SAP173800R0001		0.115
CANopen slave	Terminal block 2 x 5 poles spring	-	CM588-CN	1SAP172800R0001		0.115
PROFINET I/O RT controller	2 x RJ45 - integrated switch	Yes	CM579-PNIO	1SAP170901R0101		0.115
PROFINET IO RT device	2 x RJ45 - integrated switch	(2)	CM589-PNIO	1SAP172900R0011		0.115
PROFINET IO RT with 4 devices	2 x RJ45 - integrated switch	(2)	CM589-PNIO-4	1SAP172900R0111		0.115
EtherCAT master	2 x RJ45	Yes	CM579-ETHCAT	1SAP170902R0101		0.115
Serial + co-processor	2 x RS-232/485 on spring terminal blocks	-	CM574-RS	1SAP170400R0201		0.115
Serial RCOM	2 x RS-232/485 (1 x RCOM/1 x Console)	-	CM574-RCOM	1SAP170401R0201		0.115

(1) Only with CAN 2A/2B protocol

(2) In preparation



CM592-DP



CM574-RS
CM574-RCOM



CM598-CN



CM579-PNIO

I/O modules

- Hot swap capable when mounted on hot swap terminal unit
- For central expansion of the AC500 or AC500-eCo CPUs
- For decentralized expansion in combination with communication interface modules on CS31, PROFINET IO, EtherCAT, Modbus TCP, PROFIBUS DP, CANopen modules
- DC and AC: Channels can be configured individually as inputs or outputs
- Plug-in electronic modules, terminal unit required (refer to table below).

Digital I/O

Number of	Input signal	Output type	Output signal	Terminal units Screw / Spring	Type	Order code	Price	Weight (1 pce) kg
DI/DO/DC								
32 / - / -	24 V DC	-	-	TU515 / TU516	DI524	1SAP240000R0001		0.200
- / - / 16	24 V DC	Transistor	24 V DC, 0.5 A	TU515 / TU516	DC522	1SAP240600R0001		0.200
- / - / 24	24 V DC	Transistor	24 V DC, 0.5 A	TU515 / TU516	DC523	1SAP240500R0001		0.200
16 / - / 16	24 V DC	Transistor	24 V DC, 0.5 A	TU515 / TU516	DC532	1SAP240100R0001		0.200
8 / 8 / -	24 V DC	Relay	230 V AC, 3 A (2)	TU531 / TU532	DX522	1SAP245200R0001		0.300
8 / 4 / -	230 V AC	Relay	230 V AC, 3 A (2)	TU531 / TU532	DX531	1SAP245000R0001		0.300
- / 32 / -	-	Transistor	24 V DC, 0.5 A	TU515 / TU516	DO524	1SAP240700R0001		0.200
- / 8 / -	-	Transistor	24 V DC, 2 A	TU541 / TU542	DO526	1SAP240800R0001		0.200

(2) Relay outputs, changeover contacts.



DO524

AC500

Ordering data

Analog I/O

Number of	Input signal	Output signal	Terminal units Screw / Spring	Type	Order code	Price	Weight (1 pce) kg
AI/AO/AC							
16 / 0 / 0	0...10 V, ±10 V	–	TU515 / TU516	AI523	1SAP250300R0001		0.200
4 / 4 / 0	0/4...20 mA, PT100, PT1000, Ni1000	±10 V	TU515 / TU516	AX521	1SAP250100R0001		0.200
0 / 0 / 8 (max. 4 current outputs)		0/4...20 mA	TU515 / TU516	AC522 (1)	1SAP250500R0001		0.200
8 / 8 / 0 (max. 4 current outputs)			TU515 / TU516	AX522	1SAP250000R0001		0.200
0 / 16 / 0 (max. 8 current outputs)	–		TU515 / TU516	AO523	1SAP250200R0001		0.200
8 / 0 / 0	0...5 V, 0...10 V, ±50 mV, ±500 mV, 1 V, ±5 V, ±10 V, 0/4...20 mA, ±20 mA, PT100, PT1000, Ni1000, Cu50, 0...50 kΩ, S, T, N, K, J	–	TU515 / TU516	AI531	1SAP250600R0001		0.200

(1) In preparation

Analog/digital mixed I/O

Number of	Input signal	Output type	Output signal	Terminal unit Screw / Spring	Type	Order code	Price	Weight (1 pce) kg
AI/AO/DI/DO/DC								
4 / 2 / 16 / - / 8	24 V DC/0...10 V, -10...+10 V, 0...20 mA, 4...20 mA,	Transistor	24 V DC, 0.5 A/ -10...+10 V,	TU515 / TU516	DA501	1SAP250700R0001		0.200
4 / 2 / - / 16 / 8	PT100, PT1000, Ni100, Ni1000		0...20 mA, 4...20 mA	TU515 / TU516	DA502 (1)	1SAP250800R0001		0.200

(1) In preparation

Multifunctional modules

- Not hot swap capable

Functionality	Number of	Input signal	Output type	Output signal	Terminal units Screw / Spring	Type	Order code	Price	Weight (1 pce) kg
DI/DO/DC									
Encoder and PWM module	2 / - / 8	24 V DC and 2 encoder inputs A/B/C differential	2 PWM outputs	24 V DC, 0.1 A	TU515 / TU516	CD522	1SAP260300R0001		0.125
Positioning module	0 / 8 / 0	4 inputs 0...10 V for position feedback	4 H-bridge outputs	24 V DC, 4 A	TU541 / TU542	PD501-4CH (1)	1SAP260100R0001		0.200

(1) In preparation

Fast I/O module for direct mounting on the terminal base of the AC500 CPU

Functionality	Number of	Input signal	Output type	Output signal	Terminal unit	Type	Order code	Price	Weight (1 pce) kg
DI/DO/DC									
Interrupt I/O and fast counter	- / - / 8	24 V DC	Transistor	24 V DC, 0.5 A	N/A (2)	DC541-CM (1)	1SAP270000R0001		0.100

(1) Multifunctional module, refer to table on page 110 for details. Terminal block for I/O signal connection included.

(2) Occupies a communication module slot.



AO523



AI531



DA501



CD522



DC541-CM

AC500

Ordering data

Communication interface modules

Number of	Input signal	Output type	Output signal	Terminal units Screw / Spring	Type	Order code	Price	Weight (1 pce) kg
AI/AO/DI/DO/DC								
For CS31-Bus								
- / - / 8 / - / 16	24 V DC	Transistor	24 V DC, 0.5 A	TU551-CS31 / TU552-CS31	DC551-CS31	1SAP220500R0001		0.200
- / - / - / - / 16	24 V DC	Transistor	24 V DC, 0.5 A	TU551-CS31 / TU552-CS31	CI590-CS31-HA	1SAP221100R0001		0.200
4 / 2 / 8 / - / 8	24 V DC/ 0...10 V, -10...+10 V, 0...20 mA, 4...20 mA, PT100, PT1000, Ni100, Ni1000	Transistor	24 V DC, 0.5 A/ -10...+10 V, 0...20 mA, 4...20 mA	TU551-CS31 / TU552-CS31	CI592-CS31	1SAP221200R0001		0.200
For PROFIBUS-DP								
4 / 2 / 8 / 8 / -	24 V DC/ 0...10 V, -10...+10 V, 0...20 mA, 4...20 mA, PT100, PT1000, Ni100, Ni1000	Transistor	24 V DC, 0.5 A/ -10...+10 V, 0...20 mA, 4...20 mA (1)	TU509/TU510/ TU517/TU518	CI541-DP	1SAP224100R0001		0.200
- / - / 8 / 8 / 8	24 V DC	Transistor	24 V DC, 0.5 A	TU509/TU510/ TU517/TU518	CI542-DP	1SAP224200R0001		0.200
For CANopen								
4 / 2 / 8 / 8 / -	24 V DC/ 0...10 V, -10...+10 V, 0...20 mA, 4...20 mA, PT100, PT1000, Ni100, Ni1000	Transistor	24 V DC, 0.5 A/ -10...+10 V, 0...20 mA, 4...20 mA	TU509/TU510/ TU517/TU518	CI581-CN	1SAP228100R0001		0.200
- / - / 8 / 8 / 8	24 V DC	Transistor	24 V DC, 0.5 A	TU509/TU510/ TU517/TU518	CI582-CN	1SAP228200R0001		0.200
For Ethernet based protocol - EtherCAT								
4 / 2 / 8 / 8 / -	24 V DC/ 0...10 V, -10...+10 V, 0...20 mA, 4...20 mA, PT100, PT1000, Ni100, Ni1000	Transistor	24 V DC, 0.5 A/ -10...+10 V, 0...20 mA, 4...20 mA	TU507-ETH / TU508-ETH	CI511-ETHCAT	1SAP220900R0001		0.200
- / - / 8 / 8 / 8	24 V DC	Transistor	24 V DC, 0.5 A	TU507-ETH / TU508-ETH	CI512-ETHCAT	1SAP221000R0001		0.200
For Ethernet based protocol - PROFINET IO RT								
4/2/8/8/-	24 V DC/ 0...10 V, -10...+10 V, 0...20 mA, 4...20 mA, PT100, PT1000, Ni100, Ni1000	Transistor	24 V DC, 0.5 A/ -10...+10 V, 0...20 mA, 4...20 mA	TU507-ETH / TU508-ETH	CI501-PNIO	1SAP220600R0001		0.200
- / - / 8 / 8 / 8	24 V DC	Transistor	24 V DC, 0.5 A	TU507-ETH / TU508-ETH	CI502-PNIO	1SAP220700R0001		0.200
For Ethernet based protocol - Modbus TCP								
4/2/8/8/-	24 V DC/ 0...10 V, -10...+10 V, 0...20 mA, 4...20 mA, PT100, PT1000, Ni100, Ni1000	Transistor	24 V DC, 0.5 A/ -10...+10 V, 0...20 mA, 4...20 mA	TU507-ETH / TU508-ETH	CI521-MODTCP	1SAP222100R0001		0.200
- / - / 8 / 8 / 8	24 V DC	Transistor	24 V DC, 0.5 A	TU507-ETH / TU508-ETH	CI522-MODTCP	1SAP222200R0001		0.200



CI541-DP



CI581-CN



CI511-ETHCAT



CI501-PNIO



CI521-MODTCP

AC500

Ordering data

Communication interface modules

From	To	Output signal	Terminal units	Type	Order code	Price	Weight (1 pce) kg
Gateway on Ethernet based protocol - PROFINET IO RT							
PROFINET I/O	-	3 x RS232/422/485 ASCII serial interfaces	TU520-ETH	CI504-PNIO	1SAP221300R0001		0.200
PROFINET I/O	1x CAN 2A/2B or CANopen Master	2 x RS232/422/485 ASCII serial interfaces	TU520-ETH	CI506-PNIO	1SAP221500R0001		0.200



CI504-PNIO

Hot swap terminal units

For loadless hot swapping of digital and analog expansion modules, when used in configurations with communication interface modules or AC500 CPU supporting hot swap. Hot swapping of attached expansion module mounted on hot swap terminal unit is supported by AC500 V3 CPU modules as of PM5630-2ETH, AC500 V2 CPU modules as of PM585-ETH, CI501-PNIO, CI502-PNIO, CI541-DP, CI542-DP, CI521-MODTCP and CI522-MODTCP. AC500-S safety I/O modules cannot be used in configurations containing hot swap terminal units. Mixed configurations of hot swap terminal units with normal terminal units for digital and analog expansion modules are possible. In the installation hot swap terminal units can be identified by the word Hot Swap and a white frame around the connection terminal area.

For	Supply	Connection type	Type	Order code	Price	Weight (1 pce) kg
I/O modules - for Hot Swap (1)	24 V DC	Spring	TU516-H	1SAP215000R0001		0.300
I/O modules AC / relay - for Hot Swap (1)	230 V AC	Spring	TU532-H	1SAP215100R0001		0.300
High current I/O module - for Hot Swap (1)	24 V DC	Spring	TU542-H	1SAP215200R0001		0.300

(1) I/O module as of index F0 needed for Hot Swap



TU516-H

AC500

Ordering data

Terminal units

For digital and analog expansion modules and interface modules. Please note: for modules with relay outputs, terminal units for 230 V AC (TU531 / TU532) are required.

For	Supply	Connection type	Type	Order code	Price	Weight (1 pce) kg
Ethernet communication interface modules	24 V DC	Screw	TU507-ETH	1SAP214200R0001		0.300
		Spring	TU508-ETH	1SAP214000R0001		0.300
Ethernet gateway modules	24 V DC	Spring	TU520-ETH	1SAP214400R0001		0.300
CANopen / PROFIBUS DP (1) communication interface modules	24 V DC	Screw	TU517	1SAP211400R0001		0.300
		Spring	TU518	1SAP211200R0001		0.300
PROFIBUS DP / CANopen communication interface modules	24 V DC	Screw	TU509	1SAP211000R0001		0.300
		Spring	TU510	1SAP210800R0001		0.300
I/O modules	24 V DC	Screw	TU515	1SAP212200R0001		0.300
		Spring	TU516	1SAP212000R0001		0.300
I/O modules AC / relay	230 V AC	Screw	TU531	1SAP217200R0001		0.300
		Spring	TU532	1SAP217000R0001		0.300
High current I/O module (DO526, PD501-4CH)	24 V DC	Screw	TU541	1SAP213000R0001		0.300
	24 V DC	Spring	TU542	1SAP213200R0001		0.300
CS31 interface modules	24 V DC	Screw	TU551-CS31	1SAP210600R0001		0.300
		Spring	TU552-CS31	1SAP210400R0001		0.300

(1) TU517/TU518 Terminal units can also be used with PROFIBUS DP CI54x modules up to 1 Mbit/s.



TU515



TU520-ETH



TU510



TU518



TU508-ETH

AC500

Ordering data

Terminal units compatibility

Type	For I/O modules			For communication interface modules				
	TU515 TU516 TU516-H	TU541 TU542 TU542-H	TU531 TU532 TU532-H	TU507-ETH TU508-ETH	TU509 TU510	TU517 TU518	TU520-ETH	TU551-CS31 TU552-CS31
DA501	•							
DA502	•							
DC522	•							
DC523	•							
DC532	•							
DI524	•							
DX522			•					
DX531			•					
DO524	•							
DO526		•						
CD522	• (2)							
AC522	•							
AI523	•							
AI531	•							
AO523	•							
AX521	•							
AX522	•							
PD501-4CH		• (2)						
DC551-CS31								•
CI590-CS31-HA								•
CI592-CS31								•
CI501-PNIO				•				
CI502-PNIO				•				
CI504-PNIO							•	
CI506-PNIO							•	
CI511-ETHCAT				•				
CI512-ETHCAT				•				
CI521-MODTCP				•				
CI522-MODTCP				•				
CI541-DP					•			• (1)
CI542-DP					•			• (1)
CI581-CN					•			•
CI582-CN					•			•

(1) Can be used with baud rate up to 1 Mbaud.

(2) CD522 cannot be used on TU516-H and PD501-4CH cannot be used on TU542-H.

AC500

Ordering data

Accessories for AC500

For	Description	Type	Order code	Price	Weight (1 pce) kg
AC500 CPUs COM1	Programming cable Sub-D / terminal block, length 5 m	TK502	1SAP180200R0101		0.400
AC500 CPUs COM2	Programming cable Sub-D / Sub-D, length 5 m	TK501	1SAP180200R0001		0.400
AC500 CPUs	Memory card (2 GB SD card)	MC502	1SAP180100R0001		0.020
	Lithium battery for data buffering	TA521	1SAP180300R0001		0.100
I/O modules	Pluggable marker holder for I/O modules, packing unit incl. 10 pcs. Template available in the AC500 online help	TA523	1SAP180500R0001		0.300
AC500 CPU's, interface module, communication module and I/O modules	White labels, packing unit incl.10 pcs.	TA525	1SAP180700R0001		0.100
Terminal base	Communication Module, blind cap	TA524	1SAP180600R0001		0.120
CPU terminal base	Accessories for screw mounting, packing unit includes 10 pcs	TA526	1SAP180800R0001		0.200
	5-pole power plug for AC500. Spare part. Can be plugged to CPU terminal base TB5x1. Packing unit includes 5 pcs	TA527	1SAP181100R0001		0.200
	9-pole COM1 plug for AC500. Spare part. Can be plugged to CPU terminal base TB5x1 or on TU520-ETH. Packing unit includes 5 pcs	TA528	1SAP181200R0001		0.200
Communication modules	9-pole spring plug for CM574-RS/RCOM. Spare part. Packing unit includes 10 pcs	TA532	1SAP182000R0001		
	5-pole spring plug for CM575-DN/CM578-CN. Spare part. Packing unit includes 5 pcs	TA533	1SAP182100R0001		
	2x5-pole spring plug for CM588-CN and CM598-CN. Spare part. Packing unit includes 5 pcs.	TA534	1SAP182200R0001		
	10-pole spring plug for DC541-CM. Spare part. Packing unit includes 10 pcs.	TA536	1SAP183100R0001		
AC500 V2 training case	PM583-ETH + TB521-ETH + CM579-PNIO + DA501 + CI502-PNIO + CP6607 + Case + 115-230 V AC power supply + Ethernet cables + demo program + SD memory card + simulation stand	TA515-CASE	1SAP182400R0002		7.000
AC500 V3 training case	PM5630-2ETH + TB5620-2ETH + CM579-PNIO + DA501 + CI502-PNIO + CP6607 + Case + 115-230 V AC power supply + Ethernet cables + demo program + SD memory card + simulation stand	TA5450-CASE	1SAP187700R0001		7.000
AC500 CPUs PM595	Protective cap, spare-parts. Packing unit includes 3 pcs	TA540	1SAP182600R0001		0.200
	Lithium battery for real-time-clock buffering	TA541	1SAP182700R0001		0.030
	Accessories for screw-mounting. Packing unit includes 20 pcs	TA543	1SAP182800R0001		0.100



MC502

AC500 training case
CPU, I/Os, HMI

AC500

Technical data

AC500 CPUs

Type	PM572	PM573-ETH	PM582	PM583-ETH	PM585-ETH
Supply voltage	24 V DC				
Current consumption on 24 V DC					
Min. (module alone)	0.050 A	0.110 A	0.050 A	0.110 A	0.150 A
Max. (all couplers and I/Os)	0.750 A	0.810 A	0.750 A	0.810 A	0.850 A
User program memory – Flash EPROM and RAM	128 kB	512 kB	512 kB	1024 kB	1024 kB
Integrated user data memory	128 kB thereof 12 kB saved	512 kB thereof 288 kB saved	416 kB thereof 288 kB saved	1024 kB thereof 288 kB saved	2560 kB thereof 1536 kB saved
User Flashdisk (Data-storage, programm access or also external with FTP)	–				
Plug-in memory card	Depending on SD-Card used : no SD-HC card allowed, use MC502 accessory				
Web server's data for user RAM disk	–	1 024 kB	–	4 096 kB	4 096 kB
Data buffering	battery				
Real-time clock (with battery back-up)	●				
Cycle time for 1 instruction (minimum)					
Binary	0.06 μs	0.06 μs	0.05 μs	0.05 μs	0.004 μs
Word	0.09 μs	0.09 μs	0.06 μs	0.06 μs	0.008 μs
Floating-point	0.7 μs	0.7 μs	0.5 μs	0.5 μs	0.008 μs
Max. number of centralized inputs/outputs					
Max. number of extension modules on I/O bus	up to max. 10 (S500 and/or S500-eCo modules allowed)				
Digital	inputs/outputs 320/320				
Analog	inputs/outputs 160/160				
Max. number of decentralized inputs/outputs	depends on the used standard Fieldbus (1)				
Program execution					
Cyclical / Time controlled / Multi tasking	●/●/●				
User program protection by password	●				
Internal interfaces					
COM1					
RS232 / RS485 configurable	●				
Connection (on terminal bases or CPU module)	pluggable spring terminal block, use TK502 cable in accessory				
Programming, Modbus RTU, ASCII, CS31 master	●				
COM2					
RS232 / RS485 configurable	●				
Connection (on terminal bases or CPU module)	D-Sub 9 female, use TK501 cable in accessory				
Programming, Modbus RTU, ASCII	●				
FieldBusPlug					
Serial neutral interface	●				
Connection (on terminal bases)	M12 male, 5 pole				
Functions	programming cable UTF-21-FBP, slave communication depending on FieldBusPlug used (PROFIBUS DP, CANopen, DeviceNet)				
Ethernet					
Ethernet connection (on terminal bases)	–	RJ45	–	RJ45	RJ45
Ethernet functions: Programming, TCP/IP, UDP/IP, Modbus TCP, integrated Web server, IEC60870-5-104 remote control protocol, MQTT, SNTP (simple Network Time Protocol), DHCP, FTP server HTTP, SMTP, PING	–	●	–	●	●
Ethernet based Fieldbus					
Ethernet connection (on CPU module)	–				
Downloadable protocols like: PROFINET IO RT Controller / EtherCAT Master	–				
CPU display	LC display and 8 function keys				
Function	RUN / STOP, status, diagnosis				
LEDs for various status display	Run, Stop, Error				
Timer/Counter	unlimited/unlimited				
Approvals	See detailed page 248 or www.abb.com/plc				

(1) e.g. CS31 Fieldbus: up to 31 stations with up to 120 DIs / 120 DOs or up to 32 AIs / 32 AOs per station.

AC500

Technical data

AC500 CPUs

Type	PM590-ETH	PM591-ETH	PM591-2ETH	PM592-ETH	PM595-4ETH-F
Supply voltage	24 V DC				
Current consumption on 24 V DC					
Min. (module alone)	0.150 A	0.150 A	0.150 A	0.150 A	0.400 A
Max. (all couplers and I/Os)	0.850 A	0.850 A	0.850 A	0.850 A	1.2 A
User program memory – Flash EPROM and RAM	2048 kB	4096 kB	4096 kB	4096 kB	16384 kB
Integrated user data memory	3072 kB thereof 1536 kB saved	5632 kB thereof 1536 kB saved	5632 kB thereof 1536 kB saved	5632 kB thereof 1536 kB saved	16384 kB thereof 3072 kB saved
User Flashdisk (Data-storage, programm access or also external with FTP)	-			Yes, 4 GB Flash non removable	
Plug-in memory card	Depending on SD-Card used : no SD-HC card allowed, use MC502 accessory				
Web server's data for user RAM disk	8 MB				32 MB
Data buffering	battery				
Real-time clock (with battery back-up)	●				
Cycle time for 1 instruction (minimum)					
Binary	0.002 μs	0.002 μs	0.002 μs	0.002 μs	0.0006 μs
Word	0.004 μs	0.004 μs	0.004 μs	0.004 μs	0.001 μs
Floating-point	0.004 μs	0.004 μs	0.004 μs	0.004 μs	0.001 μs
Max. number of centralized inputs/outputs					
Max. number of extension modules on I/O bus	up to max. 10 (S500 and/or S500-eCo modules allowed)				
Digital	inputs/outputs 320/320				
Analog	inputs/outputs 160/160				
Max. number of decentralized inputs/outputs					
depends on the used standard Fieldbus (1)					
Program execution					
Cyclical / Time controlled / Multi tasking	●/●/●				
User program protection by password	●				
Internal interfaces					
COM1					
RS232 / RS485 configurable	●				
Connection (on terminal bases or CPU module)	pluggable spring terminal block, use TK502 cable in accessory				
Programming, Modbus RTU, ASCII, CS31 master	●				
COM2					
RS232 / RS485 configurable	●				
Connection (on terminal bases or CPU module)	D-Sub 9 female, use TK501 cable in accessory				
Programming, Modbus RTU, ASCII	●				
FieldBusPlug					
Serial neutral interface	●				-
Connection (on terminal bases)	M12 male, 5 pole				-
Functions	programming cable UTF-21-FBP, slave communication depending on FieldBusPlug used (PROFIBUS DP, CANopen, DeviceNet)				-
Ethernet					
Ethernet connection (on terminal bases)	RJ45	RJ45	2 x RJ45	RJ45	2 x RJ45
Ethernet functions: Programming, TCP/IP, UDP/IP, Modbus TCP, integrated Web server, IEC60870-5-104 remote control protocol, MQTT, SNTP (simple Network Time Protocol), DHCP, FTP server HTTP, SMTP, PING	●	●	●	●	●
Ethernet based Fieldbus					
Ethernet connection (on CPU module)	-				4 x RJ45 (2 x interfaces with 2-port switch)
Downloadable protocols like: PROFINET IO RT Controller / EtherCAT Master or Ethernet like ModbusTCP	-				●
CPU display					
Function	LC display and 8 function keys				RUN / STOP, status, diagnosis, RESET
LEDs for various status display	Run, Stop, Error				●
Timer/Counter	unlimited/unlimited				
Approvals					
See detailed page 248 or www.abb.com/plc					

(1) e.g. CS31 Fieldbus: up to 31 stations with up to 120 DIs / 120 DOs or up to 32 AIs / 32 AOs per station.

(2) Availability on demand

AC500

Technical data

AC500 V3 CPUs

Type	PM5630-2ETH	PM5650-2ETH	PM5670-2ETH	PM5675-2ETH
Supply voltage	24 V DC			
Current consumption on 24 V DC				
Min. typ. (module alone)	0.150 A	0.200 A	0.250 A	0.250 A
Max. typ. (all couplers and I/Os)	0.850 A	0.900 A	0.950 A	0.950 A
User program memory / User Data memory	8 MB	80 MB	160 MB	160 MB
Web server's data – Flash EPROM and DRAM				
User data memory saved	256 KB	256 KB	1.5 MB	1.5 MB
User Flashdisk (Data-storage, programm access or also external with FTP)				8 GB Flash non removable
Plug-in memory card	Depending on SD-Card used : SD / SDHC supported, use MC502 preferably accessory			
Web server's data for user RAM disk	8 MB	No limitation, included into the global User Program/ Data memory		
Data buffering	battery			
Real-time clock (with battery back-up)	●			
Cycle time for 1 instruction (minimum)				
Binary	0.02 μs	0.01 μs	0.002 μs	0.002 μs
Word	0.03 μs	0.01 μs	0.002 μs	0.002 μs
Floating-point	0.12 μs	0.01 μs	0.002 μs	0.002 μs
Communication modules supported				
Max. number of communication modules on TBs	up to 2	Up to 6 depending on available terminal bases (2)		
Type of communication module supported	CM579-PNIO, CM589-PNIO, CM579-ETHCAT, CM582-DP (2), CM592-DP (2), CM597-ETH (2) and CM598-CN (2)			
Max. number of centralized inputs/outputs				
Max. number of extension modules on I/O bus	up to max. 10 (S500 and/or S500-eCo modules allowed)			
Digital	inputs/outputs		320/320	
Analog	inputs/outputs		160/160	
Max. number of decentralized inputs/outputs	depends on the used standard Fieldbus (1)			
Program execution				
Cyclical / Time controlled / multi tasking	●/●/●			
User program protection by password	●			
Internal interfaces				
COM1				
RS232 / RS485 configurable	●			
Connection (on terminal bases or CPU module)	pluggable spring terminal block, use TK502 cable in accessory			
Modbus RTU Master/Slave, ASCII	●			
CANopen				
Serial interface	CAN serial interface			
Connection (on terminal bases)	Pluggable spring terminal block, 2x 5 poles			
Functions	CANopen Master / Slave (2) communication, CAN 2A/2B, J1939 protocol			

(1) e.g. CANopen Fieldbus: up to 127 stations with up to 320 Digital channels or up to 160 Analog channels per station.

(2) In preparation

(3) Feature is licensed

AC500

Technical data

AC500 V3 CPUs

Type	PM5630-2ETH	PM5650-2ETH	PM5670-2ETH	PM5675-2ETH
Ethernet	2x independent Ethernet interfaces for several uses			
Ethernet connection (on terminal bases)	2x RJ45 with 2x separated interfaces and MAC-Address, could be used as 2-port switch with 1x interface			
Ethernet functions:				
Online Access, ICMP (Ping), DHCP	●			
IP configuration protocol	●			
UDP data exchange, Network variables	●			
Modbus TCP Client / Server	●			
IEC60870-5-104 remote control protocol	●			
HTTP / HTTPS (integrated Web server)	●			
SNTP (Time synchronization)	●			
FTP / FTPs server	●			
SMTP client	●			
Socket programming	●			
WebVisu for data visualisation on webserver HTML5	●			
Valid for all CPU before OPC UA MQTT protocol	●			
OPC UA Server (Micro Embedded Device Server) with security	●			
Ethernet Switch on ETH1 / ETH2	●			
Ethernet based Fieldbus				
Downloadable protocols (licensed feature):	available on one Ethernet interface, the other interface can be sometimes used as switch			
IEC 61850 server	● (3)	● (3)	● (3)	● (3)
PROFINET IO RT Controller	● (2)(3)	● (2)(3)	● (2)	● (2)
EtherCAT Master	● (2)(3)	● (2)(3)	● (2)	● (2)
EthernetIP Adapter	● (2)(3)	● (2)(3)	● (2)(3)	● (2)(3)
CPU display	LC display and 8 function keys			
Function	RUN / STOP, status, diagnosis			
LEDs for various status display	●			
Timer/Counter	unlimited/unlimited			
Approvals	See detailed page 248 or www.abb.com/plc			

(1) e.g. CANopen Fieldbus: up to 127 stations with up to 320 Digital channels or up to 160 Analog channels per station.

(2) In preparation

(3) Feature is licensed

AC500

Technical data

Digital S500 I/O modules

Type	DI524	DC522	DC523	DC532
Number of channels per module				
Digital				
inputs	32	–	–	16
outputs	–	–	–	–
Configurable channels DC (configurable as inputs or outputs)	–	16	24	16
Additional configuration of channels as				
Fast counter	configuration of max. 2 channels per module, operating modes see table on page 126			
Occupies max. 1 DO or DC when used as counter	–	●	●	●
Connection via terminal unit	●	●	●	●
Digital inputs				
Input signal voltage	24 V DC			
Input characteristic acc. to EN 61132-2	Type 1			
0 signal	-3...+5 V DC			
Undefined signal state	5...15 V DC			
1 signal	15...30 V DC			
Input time delay (0 -> 1 or 1 -> 0)	8 ms typically, configurable from 0.1 up to 32 ms			
Input current per channel				
At input voltage	24 V DC 5 mA typically			
	5 V DC > 1 mA			
	15 V DC > 5 mA			
	30 V DC < 8 mA			
Digital outputs				
Transistor outputs 24 V DC, 0.5 A	–	●	●	●
Readback of output	–	●	●	●
Switching of load 24 V	–	●	●	●
Output voltage at signal state 1	–	process voltage UP minus 0.8 V		
Output current				
Nominal current per channel	–	0.5 A		
Maximum (total current of all channels)	–	8 A		
Residual current at signal state 0	–	< 0.5 mA		
Demagnetization when switching off inductive loads	–	by internal varistors		
Switching frequency				
For inductive load	–	0.5 Hz max.		
For lamp load	–	11 Hz max. at max. 5 W		
Short-circuit / overload proofness	–	●	●	●
Overload indication (I > 0.7 A)	–	after approx. 100 ms		
Output current limiting	–	yes, with automatic reclosure		
Proofness against reverse feeding of 24 V signals	–	●	●	●
Process voltage UP				
Nominal voltage	24 V DC			
Current consumption on UP				
Min. (module alone)	0.150 A	0.100 A	0.150 A	
Max. (min. + loads)	0.150 A	0.100 A + load	0.150 A + load	
Reverse polarity protection	●	●	●	●
Fuse for process voltage UP	10 A fast acting fuse			
Connections for sensor voltage supply. Terminal 24 V and 0 V for each connection. Permitted load for each group of 4 or 8 connections: 0.5 A	–	8	4	–
Short-circuit and overload proof 24 V DC sensor supply voltage	–	●	●	–
Maximum cable length for connected process signals				
Cable	shielded	1000 m		
	unshielded	600 m		
Potential isolation				
Per module		●	●	●
Between channels	input	–	–	–
	output	–	–	–
Voltage supply for the module	internally via extension bus interface (I/O bus)			
Fieldbus connection	via AC500 CPU or all communication interface modules			
Address setting	automatically (internal)			

AC500

Technical data

Digital S500 I/O modules

Type		DX522	DX531	DO524	DO526
Number of channels per module					
Digital	inputs	8	8	–	–
	outputs	8 relays	4 relays	32	8
Configurable channels DC (configurable as inputs or outputs)		–	–	–	–
Additional configuration of channels as					
Fast counter		configuration of max. 2 channels per module, operating modes see page 126	–	–	–
Occupies max. 1 DO or DC when used as counter		–	–	–	–
Connection via terminal unit		●	●	●	●
Digital inputs					
Input signal voltage		24 V DC	230 V AC or 120 V AC	–	–
Frequency range		–	47...63 Hz	–	–
Input characteristic acc. to EN 61132-2		Type 1	Type 2	–	–
0 signal		-3...+5 V DC	0...40 V AC	–	–
Undefined signal state		5...15 V DC	> 40 V AC...< 74 V AC	–	–
1 signal		15...30 V DC	74...265 V AC	–	–
Input time delay (0 -> 1 or 1 -> 0)		8 ms typically, configurable from 0.1 up to 32 ms	20 ms typically	–	–
Input current per channel					
At input voltage		24 V DC	5 mA typically	–	–
		5 V DC	> 1 mA	–	–
		15 V DC	> 5 mA	–	–
		30 V DC	< 8 mA	–	–
		40 V AC	–	< 5 mA	–
		74 V AC	–	> 6 mA	–
Digital outputs					
Transistor outputs 24 V DC		–	–	●	●
Readback output		–	–	–	–
Relay outputs, supplied via process voltage UP, changeover contacts		●	●	–	–
Switching of load		24 V	●	●	●
		230 V	●	●	–
Output voltage at signal state 1		–	–	process voltage UP minus 0.8 V	process voltage UP minus 0.4 V
Output current					
Nominal current per channel		–	–	0.5 A	2 A
Maximum (total current of all channels)		–	–	8 A	16 A
Residual current at signal state 0		–	–	< 0.5 mA	< 0.1 mA
Demagnetization when switching off inductive loads		–	–	yes	yes
Switching frequency					
For inductive load		2 Hz	–	0.5 Hz max.	2 Hz max.
For lamp load		11 Hz max. at max. 5 W	–	–	11 Hz max. 48 W
Short-circuit / overload proofness		by external fuse / circuit breaker. 6 A gL/gG per channel	–	●	by external fuse 10A fast
Overload indication (I > 0.7 A)		–	–	after approx. 100 ms	–
Output current limiting		–	–	yes, with automatic reclosure	–
Resistance against reverse feeding of 24 V signals		–	–	●	●

AC500

Technical data

Digital S500 I/O modules

Type	DX522	DX531	DO524	DO526
Contact rating				
For resistive load, max.	3 A at 230 V AC 2 A at 24 V DC		–	–
For inductive load, max.	1.5 A at 230 V AC 1.5 A at 24 V DC		–	–
For lamp load	60 W at 230 V AC 10 W at 24 V DC		–	–
Lifetime (switching cycles)				
Mechanical lifetime	300 000		–	–
Lifetime under load (DC13)	300 000 at 24 V DC / 2 A 200 000 at 120 V AC / 2 A 100 000 at 230 V AC / 3 A		–	–
Spark suppression for inductive AC load	external measure depending on the switched load		–	–
Demagnetization for inductive DC load	external measure: free-wheeling diode connected in parallel to the load		–	–
Process voltage UP				
Nominal voltage	24 V DC			
Current consumption on UP				
Min. (module alone)	0.050 A	0.150 A	0.050 A	0.050 A
Max. (module + loads)	0.050 A + load	0.150 A + load	0.100 A + load	0.100 A + load
Reverse polarity protection	●	●	●	●
Fuse for process voltage UP	10 A			
Maximum cable length for connected process signals				
Cable	shielded	1000 m		
	unshielded	600 m		
Potential isolation				
Per module	●	●	●	●
Between the channels	input	–	● (per 2)	–
	output	●	●	–
Voltage supply for the module	internally via extension bus interface (I/O bus)			
Fieldbus connection	via AC500 CPU or all communication interface modules			
Address setting	automatically (internal)			

AC500

Technical data

Analog S500 I/O modules

Type		AX521	AX522	AC522	AI523	AO523	AI531	
Number of channels per module								
Individual configuration, analog	inputs	4	8	–	16	–	8	
	outputs	4	8	–	–	16	–	
	configurable	–	–	8	–	–	–	
Signal resolution for channel configuration								
-10...+10 V		12 bits + sign						15 bits + sign
0...10 V		12 bits						15 bits
0...20 mA, 4...20 mA		12 bits						15 bits
Temperature: 0.1 °C		•	•	•	•	–	0.1/0.01	
Monitoring configuration per channel								
Plausibility monitoring		•	•	•	•	•	•	
Wire break & short-circuit monitoring		•	•	•	•	•	•	
Analog Inputs AI								
Signal configuration per AI		max. number per module and with regard to the configuration: AIs / Measuring points (depending on the use of 2/3-wire connection or differential input)						
-50...+50 mV, -500...+500 mV, -1...+1 V, -5...+5 V, 0...+5 V		–	–	–	–	–	8 / 8	
0...10 V		4 / 4	8 / 8	8 / 8	16 / 16	–	8 / 8	
-10...+10 V		4 / 4	8 / 8	8 / 8	16 / 16	–	8 / 8	
0...20 mA		4 / 4	8 / 8	8 / 8	16 / 16	–	8 / 8	
4...20 mA		4 / 4	8 / 8	8 / 8	16 / 16	–	8 / 8	
-20...+20 mA		–	–	–	–	–	8 / 8	
Pt100								
-50...+400 °C (2-wire)		4 / 4	8 / 8	8 / 8	16 / 16	–	8 / 8	
-50...+400 °C (3-wire), 2 channels		4 / 2	8 / 4	8 / 4	16 / 8	–	8 / 8	
-50...+400 °C (4-wire)		–	–	–	–	–	8 / 8	
-50...+70 °C (2-wire)		4 / 4	8 / 8	8 / 8	16 / 16	–	8 / 8	
-50...+70 °C (3-wire), 2 channels		4 / 2	8 / 4	8 / 4	16 / 8	–	8 / 8	
-50...+70 °C (4-wire)		–	–	–	–	–	8 / 8	
Pt1000								
-50...+400 °C (2-wire)		4 / 4	8 / 8	8 / 8	16 / 16	–	8 / 8	
-50...+400 °C (3-wire), 2 channels		4 / 2	8 / 4	8 / 4	16 / 8	–	8 / 8	
-50...+400 °C (4-wire)		–	–	–	–	–	8 / 8	
Ni1000								
-50...+150 °C (2-wire)		4 / 4	8 / 8	8 / 8	16 / 16	–	8 / 8	
-50...+150 °C (3-wire), 2 channels		4 / 2	8 / 4	8 / 4	16 / 8	–	8 / 8	
-50...+150 °C (4-wire)		–	–	–	–	–	8 / 8	
Cu50 -200...+200 °C		–	–	–	–	–	8 / 8	
Resistor 0...50 kΩ		–	–	–	–	–	8 / 8	
Thermocouples of types J, K, T, N, S		–	–	–	–	–	•	
0...10 V using differential inputs, 2 channels		4 / 2	8 / 4	8 / 4	16 / 8	–	8 / 8	
-10...+10 V using differential inputs, 2 channels		4 / 2	8 / 4	8 / 4	16 / 8	–	8 / 8	
Digital signals (digital input)		4 / 4	8 / 8	8 / 8	16 / 16	–	8 / 8	
Input resistance per channel		voltage: > 100 kΩ current: approx. 330 Ω				–	voltage: > 100 kΩ current: approx. 330 Ω	
Time constant of the input filter		voltage: 100 μs current: 100 μs				–	voltage: 100 μs current: 100 μs	
Conversion cycle		2 ms (for 8 AI + 8 AO), 1 s for Pt100/1000, Ni1000				–	1 ms 1 s for Pt100/1000, Ni1000	
Overvoltage protection		•	•	•	•	–	•	

AC500

Technical data

Analog S500 I/O modules

Type		AX521	AX522	AC522	AI523	AO523	AI531	
Data when using the AI as digital input								
Input	time delay	8 ms typically, configurable from 0.1 up to 32 ms				–	8 ms typically, configurable from 0.1 up to 32 ms	
	signal voltage	24 V DC				–	24 V DC	
Signal	0	-30...+5 V				–	-30...+5 V	
	1	13...30 V				–	13...30 V	
Analog outputs AO								
Possible configuration per AO		Max. number of AOs per module and with regard to the configuration:						
	-10...+10 V	4	8	8	–	16	–	
	0...20 mA	4	4	4	–	8	–	
	4...20 mA	4	4	4	–	8	–	
Output	resistance (burden) when used as current output	0...500 Ω				–	0...500 Ω	–
	loading capability when used as voltage output	Max. ±10 mA				–	Max. ±10 mA	–
Process voltage UP								
Nominal voltage		24 V DC						
Current consumption on UP								
	Min. (module alone)	0.150 A					0.130 A	
	Max. (min. + loads)	0.150 A + load	0.150 A + load		–	0.150 A + load		
Reverse polarity protection		●	●	●	●	●	●	
Max. line length of the analog lines, conductor cross section > 0.14 mm ²		100 m						
Conversion error of analog values caused by non-linearity, calibration errors ex works and the resolution in the nominal range		0.5 % typically, 1 % max.					Voltage: 0.1 % typically, current/resistor 0.3 % typically	
Potential isolation								
Per module		●	●	●	●	●	–	
Fieldbus connection		Via AC500 CPU or all communication interface modules						
Voltage supply for the module		Internally via extension bus interface (I/O bus)						

(1) Half can be used on current (the other half remains available).

AC500

Technical data

CD522 encoder module

The CD522 module offers accuracy and dynamic flexibility for a customized solution. It has two independent encoder inputs onboard and is easily configured using the Automation Builder software for 10 different operation modes and for frequencies up to 300 kHz (depending on CPU cycle time). The CD522 module also integrates outputs for pulses and for PWM as well as normal inputs and outputs, depending on selected encoder mode.

Type		CD522
Functionality		
Digital inputs/outputs		24 V DC, dedicated inputs/outputs can be used for specific counting functions. All unused inputs/outputs can be used as input/output with standard specification.
	Input options	Catch/Touch operation, counter value stored in separate variable on external event (rising or falling) Set to preset counter register with predefined value Set to reset counter register
	End value output	Output set when predefined value is reached
	Reference point initialization (RPI) input for relative encoder initialization	●
High-speed counter/encoder		
Integrated counters		
	Counter characteristics	2 counters (24 V DC, 5 V DC, differential and 1 Vpp sinus input)
	Counter mode	one 32 bits or two 16 bits
	Relative position encoder	X1, X2, X4
	Absolute SSI encoder	●
	Time frequency meter	●
	Frequency input	up to 300 kHz
PWM/pulse outputs		
Output mode specification		
	Number of outputs	2
	Push pull output	24 V DC, 100 mA max
	Current limitation	Thermal and overcurrent
PWM mode specification		
	Frequency	1...100 kHz
	Value	0...100 %
Pulse mode specification		
	Frequency	1...15 kHz
	Pulse emission	1...65535 pulses
	Number of pulses emitted indicator	0...100 %
Frequency mode specification		
	Frequency output	100 kHz
	Duty Cycle	Set to 50 %
Number of channels per module		
Digital		
	input	2
	output	2
Configurable channels DC (configurable as inputs or outputs)		8
Additional configuration of channels as		
Fast counter		Integrated 2 counter encoders
Connection via terminal unit		●
Digital Inputs		
Input		
	signal voltage	24 V DC
	time delay	8 ms typically configurable from 0.1 up to 32 ms
Input current per channel		
At input voltage		
	24 V DC	Typically 5 mA
	5 V DC	> 1 mA
	15 V DC	> 5 mA
	30 V DC	< 8 mA
Digital outputs		
Output voltage at signal state 1		UP – 0.8 V

AC500

Technical data

CD522 encoder module

Type	CD522	
Output current		
Nominal current per channel	0.5 A	
Maximum (total current of all channels)	8 A	
Residual current at signal state 0	< 0.5 mA	
Demagnetization when switching off inductive loads	By internal varistors	
Switching frequency		
For inductive load	Max. 0.5 Hz	
For lamp load	Max. 11 Hz with max. 5 W	
Short-circuit / Overload proofness	•	
Overload indication ($I > 0.7 \text{ A}$)	After approx. 100 ms	
Output current limiting	•	
Proofness against reverse feeding of 24 V signals	•	
Maximum cable length for connected process signals		
Cable	shielded	1000 m
	unshielded	600 m
Potential isolation		
Per module	•	
Technical data of the high-speed inputs		
Number of channels per module	6	
Input type	24 V DC, 5 V DC / Differential / Sinus 1 Vpp	
Frequency	300 kHz	
Technical data of the fast outputs		
Number of channels	2	
Indication of the output signals	Brightness of the LED depends on the number of pulses emitted (0 % to 100 %) (pulse output mode only)	
Output current		
Rated value, per channel	100 mA	
Maximum value (all channels together, configurable outputs included)	8 A	
Leakage current with signal 0	< 0.5 mA	
Rated protection fuse on UP	10 A fast	
De-magnetization when inductive loads are switched off	with varistors integrated in the module	
Overload message ($I > 0.1 \times I_A$)	Yes, after ca. 100 ms	
Output current limitation	Yes, automatic reactivation after short-circuit/overload	
Resistance to feedback against 24 V signals	Yes	
Process voltage UP		
Nominal voltage	24 V DC	
Maximum ripple	5 %	
Current consumption on UP		
Min. (module alone)	0.070 A	
Max. (min. + loads)	0.070 A + load	
Reverse polarity protection	•	
Fuse for process voltage UP	10 A miniature fuse	

AC500

Technical data

Analog/digital mixed I/O expansion modules

For all modules: max cable length for connected process signals is 1000 m for shielded cable and 600 m for unshielded ones. For all Input modules, the signal resolution for channel configuration is: -10...+10 V: 12 bit + sign; 0...10 V, 0...20 mA, 4...20 mA: 12 bits.

Type	DA501	DA502
Number of Channels per Module		
Digital	16	–
inputs	–	16
outputs	–	–
Analog	4	4
inputs	2	2
outputs	–	–
Digital configurable channels DC (configurable as inputs or outputs)	8	8
Additional configuration of channels as		
Fast counter	Yes	
Occupies max. 1 DO or DC when used as counter	Configuration of max. 2 channels per module. Operating modes see table on page 126	
Connection via terminal unit TU 5xx	●	
Digital inputs		
Input	24 V DC	
signal voltage	Type 1	
characteristic acc. to EN 61132-2		
0 signal	-3...+5 V DC	
Undefined signal state	5...15 V DC	
1 signal	15...30 V DC	
Residual ripple, range for	-3...+5 V DC	
0 signal	15...30 V DC	
1 signal		
Input time delay (0 -> 1 or 1 -> 0)	8 ms typically, configurable from 0.1 up to 32 ms	
Digital outputs		
Transistor outputs 24 V DC, 0.5 A	●	
Readback of output	●	
Outputs, supplied via process voltage UP	●	
Switching of 24 V load	●	
Output voltage at signal state 1	Process voltage UP - 0.8 V	
Output current		
Nominal current per channel	0.5 A	
Maximum (total current of all channels)	4 A	
Residual current at signal state 0	< 0.5 mA	
Demagnetization when switching off inductive loads	By internal varistors	
Analog inputs AI		
Max. number per module and with regard to the configuration: AIs / Measuring points		
Signal configuration per AI	●	
0...10 V / -10 ... +10 V	4 / 4	
0...20 mA / 4...20 mA	4 / 4	
RTD using 2/3 wire needs 1/2 channel(s)	4 / 2	
0...10 V using differential inputs, needs 2 channels	4 / 2	
-10...+10 V using differential inputs, needs 2 channels	4 / 2	
Digital signals (digital input)	4 / 4	
Data when using the AI as digital input		
Input	8 ms typically, configurable from 0.1 up to 32 ms	
time delay	24 V DC	
signal voltage		
Outputs, single configurable as		
Possible configuration per AO	●	
-10...+10 V	●	
0...20 mA / 4...20 mA	●	
Output resistance (load) when used as current output	0...500 Ω	
Output loading capability when used as voltage output	±10 mA max.	
Potential isolation		
Per module	●	
Process voltage UP		
Nominal voltage	24 V DC	
Maximum ripple	5 %	
Current consumption on UP		
Min. (module alone)	0.070 A	
Max. (min. + loads)	0.070 A + load	
Reverse polarity protection	●	
Fuse for process voltage UP	10 A fast	
Approvals	See detailed page 248 or www.abb.com/plc	

AC500

Technical data

Positioning module PD501-4CH

The module is intended for positioning with 24 V DC motors. The movement of 4 motors can be controlled in forward and reverse direction. One analog input per axis is provided to read back the position.

Type	PD501-4CH
Number of channels per module	
Digital outputs	4
Analog inputs	4
Sensor supply output	1
Digital outputs	
Type of outputs	Full H bridge with transistor
Rating of outputs	24 V DC, 4 A
Analog inputs	
Input type	Voltage
Input range	0 to 10 V
Error at 25°C	0.5 %
Resolution	12 bit
Sensor supply output	
Output voltage	10 V DC
Accuracy	0.1 %
Max. load current	90 mA
Overload protection	
Process voltage UP	•
Nominal voltage	24 V DC
Potential isolation	
Per module	•
Between digital output channels	In groups of 2 outputs
Between analog and digital channels	•

AC500

Technical data

DC541-CM interrupt I/O and fast counter module

In the operating mode counter, the channels can be configured as follows:

Input, Output, 32-bit up/down counter (uses C0...C3) as a 32-bit counter without limit, 32-bit periodic counter as a 32-bit counter with a limit, limiter for a 32-bit counter (limit channel 0), 32-bit up counter (forward counter) with the frequencies 50 kHz, 5 kHz and 2.5 kHz, pulse-width modulation (PWM) with a resolution of 10 kHz, time and frequency measurement, frequency output.

Type	DC541-CM	
Number of channels per module		
Configurable channels DC (configurable as inputs or outputs)	8	
Additional configuration of channels as		
Fast counter	Yes	
Connection via CPU terminal base. Occupies one communication module slot	●	
Digital inputs		
Input	signal voltage	24 V DC
	characteristic acc. to EN 61132-2	Type 1
0 signal	-3...+5 V DC	
Undefined signal state	5...15 V DC	
1 signal	5...30 V DC	
Input time delay (0 -> 1 or 1 -> 0)	20 µs Clamp to clamp - 300 µs with interrupt task	
Input current per channel		
At input voltage	24 V DC	5 mA typically
	5 V DC	> 1 mA
	15 V DC	> 5 mA
	30 V DC	< 8 mA
Digital outputs		
Transistor outputs 24 V DC, 0.5 A	●	
Readback of output	●	
Switching of 24 V load	●	
Output voltage at signal state 1	Process voltage UP minus 0.8 V	
Output current		
Nominal current per channel	0.5 A	
Maximum (total current of all channels)	4 A	
Residual current at signal state 0	< 0.5 mA	
Demagnetization when switching off inductive loads	yes	
Potential isolation		
Per module	●	
Voltage supply for the module	Internally via backplane bus	

Interrupt I/O table

Configuration as		Configuration for channel no.					Max. no. of channels for this function	Remarks and notes regarding possible alternative combinations of the remaining channels (a and b)
		Chan. 0	Chan. 1	Chan. 2	Chan. 3	Chan. 4-7		
Mode 1: Interrupt functionality								
Interrupt	Digital input	1	1	1	1	4	8	Each channel can be configured individually as interrupt input or output
	Digital output	1	1	1	1	4	8	
Mode 2: Counting functionality								
Digital I/Os PWM (1)	Digital input	1	1	1	1	4	8	Usual input
	Digital output	1	1	1	1	4	8	Usual output
	PWM, resolution 10 kHz	1	1	1	1	4	8	Outputs and pulsed signal with and adjustable on-off ratio

(1) Counter and fast counter data available on technical documentation.

AC500

Technical data

AC500 Condition Monitoring CMS: FM502-CMS

The FM502-CMS function module offers precision and dynamic flexibility for customized solutions in condition monitoring, precise measurement or fast data logging applications. It has 16 fast, precise and synchronized analog inputs with 50k Samples/s (SPS), 24bit ADC resolution, completed with encoder inputs (incremental or absolute) with counter and additional DI and DC inputs/outputs onboard. It is easily configured using the Automation Builder software and the special libraries. Overall it has 12 different operation modes. One FM502 function module can be placed on the right side of PM592-ETH CPU with a special function module terminal base TF5x1, to interface directly to the CPU. While long measurements can be flexibly configured, started and stopped, all inputs are available in the I/O Image of CPU for immediate use (measurement, protection, control, ...)

Type	FM502-CMS	
Data storage		
Fast user data memory of FM502	128 MB (ca. 33 million Samples: e.g 40 s record length on 16 channels at 50k SPS or 5.8 h record length on 16 channels at 100 SPS or 93 h on 1 channel at 100 SPS)	
File Format delivered to PM592 flash	WAV (compact binary) per channel, all channels in one *.zip w. time stamp	
Analog inputs		
Number of channels	16 (synchronous sampled)	
Resolution	24 bit ADC, stored in DINT in WAV file (4byte per value)	
Accuracy at +25 °C	< +/- 0.1 %	
Accuracy over operating temperature and vibration	< +/- 0.5 %	
Sample rate / Bandwidth (High, 0 dB)	50k SPS / 20 kHz to 100 SPS / 40 Hz (digitally downsampled, selectable per channel)	
Indication of the input signal	One bicolor LED per channel for configuration, measurement status, error messages	
Input option:	IEPE (with Sensor supply current)	+ - 10 V
Bandwidth low (- 3 dB)	digital < 0.1 Hz	digital < 0.1 Hz or DC (selectable)
Pass band high (- 3 dB)	analog > 90 kHz, digital > 24.5 kHz	
Stop band high (> - 100 dB)	analog > 1 MHz, digital > 27.5 kHz	
Dynamic Range (SFDR)	> 100 dB	
SINAD (300 Hz/1 kHz sine, 50 k SPS) 0dB from full scale	< -90 dB	< - 95 dB
IEPE Current Source per channel	Typ. 4.2 mA (+/- 7 % over temperature)	(n.a.)
Resistance AI- to M (ground)	Typ ~ 270Ohm (PTC)	
Channel input impedance (AI+/AI-):		
< 1kHz	> 1 MOhm	> 2 MOhm
5kHz	> 100 kOhm	> 40 kOhm
10kHz	> 60 kOhm	> 25 kOhm
20kHz	> 40 kOhm	> 8 kOhm
Error detection	Short circuit, open wire	
Max. cable length, shielded (depending on sensor)	100 m	
Digital inputs/outputs		
	24 V DC, dedicated inputs/outputs can be used for specific counting functions. All unused inputs/outputs can be used as normal input/output with standard specification.	
Channels and types	2 DI + 2 DC (configurable inputs/outputs); Type 1, LED indication	
Input options	Catch/Touch operation, counter value stored in separate variable on external event (rising or falling) Set to preset counter register with predefined value Set to reset counter register	
End value output	Output set when predefined value is reached	
Reference point initialization (RPI) input for relative encoder initialization	●	
Input current p. channel @ V DC		
24 V DC	Typically 5 mA	
5 V DC	> 1 mA	
15 V DC	> 5 mA	
30 V DC	< 8 mA	

AC500

Technical data

AC500 communication modules

- Up to 4 communications modules can be used on an AC500 CPU
- No external power supply required.

Type	CM592-DP	CM582-DP	CM597-ETH	CM598-CN	CM588-CN	CM579-PNIO
Communication interfaces						
RJ45	–	–	● (x 2) (2)	–	–	● (x 2) (2)
RS-232 / 485	–	–	–	–	–	–
Terminal blocks (1)	–	–	–	●	●	–
Sub-D socket	●	●	–	–	–	–
Protocols	PROFIBUS DP V0/V1 master	PROFIBUS DP V0/V1 slave	Ethernet (TCP/IP, UDP/IP, Modbus TCP)	CANopen master	CANopen slave	PROFINET IO controller
CPU interface	8 kB Dual-port memory	8 kB Dual-port memory	8 kB Dual-port memory	8 kB Dual-port memory	8 kB Dual-port memory	8 kB Dual-port memory
Transfer Rate	9.6 kbit/s to 12 Mbit/s	9.6 kbit/s to 12 Mbit/s	10 / 100 Mbit/s	10 kbit/s to 1 Mbit/s	10 kbit/s to 1 Mbit/s	100 Mbit/s
Co-processor						
Memory	–	–	–	–	–	–
Additional features	Multi master functionality Max. Number of subscribers: • 126 (V0) • 32 (V1)	–	Online access, ICMP (Ping), DHCP, IP configuration protocol, UDP data exchange, Modbus TCP	CAN 2.0A CAN 2.0B CANopen	NMT Slave PDO SDO server Heartbeat Nodeguard	RTC - Real-time Cyclic Protocol, Class 1 RTA - Real-time Acyclic Protocol DCP Discovery and Configuration Protocol CL-RPC - Connectionless Remote Procedure Call

Type	CM589-PNIO	CM589-PNIO-4	CM579-ETHCAT	CM574-RS	CM574-RCOM
Communication interfaces					
RJ45	● (x 2) (2)	● (x 2) (2)	● (x 2)	–	–
RS-232 / 485	–	–	–	● (x 2)	● (x 2)
Terminal blocks (1)	–	–	–	● (x 2)	● (x 2)
Sub-D socket	–	–	–	–	–
Protocols	PROFINET IO device	PROFINET IO 4 x devices	EtherCAT master	Serial COM ASCII, Modbus RTU, CS31	Serial RCOM/RCOM+
CPU interface	8 kB Dual-port memory	8 kB Dual-port memory	8 kB Dual-port memory	8 kB Dual-port memory	8 kB Dual-port memory
Transfer Rate	100 Mbit/s	100 Mbit/s	10 / 100 Mbit/s	9.6 kBit/s up to 187.5 kBit/s	2,4 kBit/s to 19.2 kBit/s
Co-processor					
Memory	–	–	–	Programmable CPU like PM57x with PowerPC 50 MHz processor 256 kB program memory 384 kB data memory	–
Additional features	RTC - Real-time Cyclic Protocol, Class 1 RTA - Real-time Acyclic Protocol DCP Discovery and Configuration Protocol LLDP - Link Layer Discovery Protocol	RTC - Real-time Cyclic Protocol, Class 1 RTA - Real-time Acyclic Protocol DCP Discovery and Configuration Protocol LLDP - Link Layer Discovery Protocol	CoE (Can over Ethercat) process data (PDO) (cyclic) CoE Mailbox data (SDO) (acyclic) Distributed Clock (32-bit, 64-bit)	• Stand alone CPU in coupler module housing allowing to be used as standard serial interface or as free programmable serial interface coupler. • Independant internal CPU programmable for own communication protocol or data processing. • 2 x CS31 master, Modbus master/slave, free configurable, protocols ASCII.	–

(1) Plug-in terminal block included.

(2) 10 / 100 Mbit/s, full/half duplex with auto-sensing, 2-port switch integrated

AC500

Technical data

Communication interface modules

For all modules: max cable length for connected process signals is 1000 m for shielded cable and 600 m for unshielded ones. For all Input modules, the signal resolution for channel configuration is:
 -10...+10 V: 12 bits + sign; 0...10 V, 0...20 mA, 4...20 mA: 12 bits. Temperature: 0.1 °C.

Type	DC551-CS31	CI590-CS31-HA (1)	CI592-CS31	
Communication Interface				
Protocol	Proprietary CS31 bus protocol on RS485 interface			
ID configuration	Per rotary switches on front face from 00d to 99d			
Field bus connection on terminal units	CS31 field bus, via terminal / redundant for CI590-CS31-HA on TU551-CS31 or TU552-CS31			
Number of Channels per Module				
Digital	inputs	8	-	8
	outputs	-	-	-
Analog	inputs	-	-	4
	outputs	-	-	2
Digital configurable channels DC (configurable as inputs or outputs)		16	16	8
Additional configuration of channels as				
Fast counter	Configuration of max. 2 channels per module			
Occupies max. 1 DO or DC when used as counter	●	●	●	
Connection				
Via terminal unit TU5xx	●	●	●	
Local I/O extension				
Max. number of extension modules	max. 7 x S500 extension modules (standard or eCo), up to 31 stations with up to 120 DIs/120 DOs or up to 32 AIs/32AOs per station			
			not for S500-eCo I/O modules	
Digital inputs				
Input	signal voltage	24 V DC		
	characteristic acc. to EN 61132-2	Type 1		
0 signal		-3...+5 V DC		
Undefined signal state		5...15 V DC		
1 signal		15...30 V DC		
Residual ripple, range for	0 signal	-3...+5 V DC		
	1 signal	15...30 V DC		
Input time delay (0 -> 1 or 1 -> 0)	8 ms typically, configurable from 0.1 up to 32 ms			
Digital outputs				
Transistor outputs 24 V DC, 0.5 A	●			
Readback of output	●			
Outputs, supplied via process voltage UP	●			
Switching of 24 V load	●			
Output voltage at signal state 1	Process voltage UP - 0.8 V			
Output current				
Nominal current per channel	0.5 A			
Maximum (total current of all channels)	8 A	8 A	4 A	
Residual current at signal state 0	< 0.5 mA			
Demagnetization when switching off inductive loads	By internal varistors			
Analog inputs AI				
Max. number per module and with regard to the configuration: AIs / Measuring points				
Signal configuration per AI	-		●	
0...10 V / -10...+10 V	-		4 / 4	
0...20 mA / 4...20 mA	-		4 / 4	
RTD using 2/3 wire needs 1/2 channel(s)	-		4 / 2	
0...10 V using differential inputs, needs 2 channels	-		4 / 2	
-10...+10 V using differential inputs, needs 2 channels	-		4 / 2	
Digital signals (digital input)	-		4 / 4	

(1) Dedicated to High Availability.

AC500

Technical data

Communication interface modules

Type	DC551-CS31	CI590-CS31-HA (1)	CI592-CS31
Data when using the AI as digital input			
Input	time delay	–	8 ms typically, configurable from 0.1 up to 32 ms
	signal voltage	–	24 V DC
Outputs, single configurable as			
Possible configuration per AO		–	•
-10...+10 V		–	•
0...20 mA / 4...20 mA		–	•
Output	resistance (load) when used as current output	–	0...500 Ω
	loading capability when used as voltage output	–	±10 mA max.
Potential isolation			
Per module		•	•
Between fieldbus interface against the rest of the module		•	•
Voltage supply for the module		By external 24 V DC voltage via terminal UP	
Process voltage UP			
Nominal voltage		24 V DC	
Current consumption on UP			
Min. (module alone)		0.100 A	0.100 A
Max. (min. + loads)		0.100 A + load	0.100 A + load
Reverse polarity protection		•	
Fuse for process voltage UP		10 A miniature fuse	
Approvals		See detailed page 248 or www.abb.com/plc	

(1) Dedicated to High Availability.

AC500

Technical data

PROFIBUS-DP modules

Type	CI541-DP	CI542-DP
Communication Interface		
Protocol	PROFIBUS DP (DP-V0 and DP-V1 slave)	
ID configuration	Per rotary switches on front face from 00h to FFh	
Field bus connection on terminal units	Sub-D 9 poles on TU509, TU510 preferred but TU517/TU518 can be used with baud rate up to 1Mbaud	
Number of Channels per Module		
Digital	inputs	8
	outputs	8
Analog	inputs	–
	outputs	–
Digital configurable channels DC (configurable as inputs or outputs)	–	8
Additional configuration of channels as		
Fast counter (onboard I/O)	Configuration of max. 2 DI channels per module	
Occupies max 1 DO or DC when used as counter	●	
Connection		
Local I/O extension	●	
Max. number of extension modules	max. 10 x S500 extension modules (standard or eCo modules allowed). Fast counter from digital IO modules can be also used.	
Via terminal unit TU5xx	●	
Digital inputs		
Input	signal voltage	24 V DC
	characteristic acc. to EN 61132-2	Type 1
0 signal		-3...+5 V DC
Undefined signal state		5...15 V DC
1 signal		15...30 V DC
Residual ripple, range for	0 signal	-3...+5 V DC
	1 signal	15...30 V DC
Input time delay (0 -> 1 or 1 -> 0)	8 ms typically, configurable from 0.1 up to 32 ms	
Digital outputs		
Transistor outputs 24 V DC, 0.5 A	●	
Readback of output	–	● (on DC outputs)
Outputs, supplied via process voltage UP	●	
Switching of 24 V load	●	
Output voltage at signal state 1	Process voltage UP - 0.8 V	
Output current		
Nominal current per channel	0.5 A	
Maximum (total current of all channels)	8 A	
Residual current at signal state 0	< 0.5 mA	
Demagnetization when switching off inductive loads	By internal varistors	
Analog Inputs AI		
	Max. number per module and with regard to the configuration: AIs / Measuring points	
Signal configuration per AI	4	–
0...10 V / -10...+10 V	4 / 4	–
0...20 mA / 4...20 mA	4 / 4	–
RTD using 2/3 wire needs 1/2 channel(s)	4 / 2	–
0...10 V using differential inputs, needs 2 channels	4 / 2	–
-10...+10 V using differential inputs, needs 2 channels	4 / 2	–
Digital signals (digital input)	4 / 4	–
Data when using the AI as digital input		
Input	Input time delay	8 ms typically, configurable from 0.1 up to 32 ms
	signal voltage	24 V DC

AC500

Technical data

PROFIBUS-DP modules

Type	CI541-DP	CI542-DP
Outputs, single configurable as		
Possible configuration per AO	●	–
-10...+10V	●	–
0...20 mA / 4...20 mA	●	–
Output resistance (load) when used as current output	0...500 Ω	–
loading capability when used as voltage output	±10 mA max.	–
Potential isolation		
Per module	●	●
Between fieldbus interface against the rest of the module	●	●
Between the channels		
input	–	–
output	–	–
Voltage supply for the module	By external 24 V DC voltage via terminal UP	
Process voltage UP		
Nominal voltage	24 V DC	
Current consumption on UP		
Min. (module alone)	0.260 A	
Max. (min. + loads)	0.260 A + load	
Reverse polarity protection	●	
Fuse for process voltage UP	10 A miniature fuse	
Approvals	See detailed page 248 or www.abb.com/plc	

AC500

Technical data

CANopen modules

Type	CI581-CN	CI582-CN	
Communication interface			
Protocol	CANopen slave, DS401 profile selectable using rotary switches		
ID configuration	Per rotary switches on front face for CANopen ID node from 00h to 7Fh and 80h to FFh for CANopen DS401 profile		
Field bus connection on terminal units	Terminal blocks on TU517/TU518 or TU509/TU510		
Number of channels per module			
Digital	inputs	8	
	outputs	8	
Analog	inputs	–	
	outputs	–	
Digital configurable channels DC (configurable as inputs or outputs)	–	8	
Additional configuration of channels as			
Fast counter (onboard I/O)	Configuration of max. 2 DI channels per module		
Occupies max. 1 DO or DC when used as counter	●	●	
Connection			
Local I/O extension	●		
Max. number of extension modules	max. 10 x S500 extension modules (standard or eCo modules are allowed)		
Via terminal unit TU5xx	●	●	
Digital inputs			
Input	signal voltage	24 V DC	
	characteristic acc. to EN 61132-2	Type 1	
0 signal		-3...+5 V DC	
Undefined signal state		5...15 V DC	
1 signal		15...30 V DC	
Residual ripple, range for	0 signal	-3...+5 V DC	
	1 signal	15...30 V DC	
Input time delay (0 -> 1 or 1 -> 0)	8 ms typically, configurable from 0.1 up to 32 ms		
Digital outputs			
Transistor outputs 24 V DC, 0.5 A	●		
Readback of output	–	● (on DC outputs)	
Outputs, supplied via process voltage UP	●		
Switching of 24 V load	●		
Output voltage at signal state 1	Process voltage UP - 0.8 V		
Output current			
Nominal current per channel	0.5 A		
Maximum (total current of all channels)	8 A		
Residual current at signal state 0	< 0.5 mA		
Demagnetization when switching off inductive loads	By internal varistors		
Analog Inputs AI	Max. number per module and with regard to the configuration: AIs / Measuring points		
Signal configuration per AI	4	–	
0...10 V / -10...+10 V	4 / 4	–	
0...20 mA / 4...20 mA	4 / 4	–	
RTD using 2/3 wire needs 1/2 channel(s)	4 / 2	–	
0...10 V using differential inputs, needs 2 channels	4 / 2	–	
-10...+10 V using differential inputs, needs 2 channels	4 / 2	–	
Digital signals (digital input)	4 / 4	–	
Data when using the AI as digital input			
Input	time delay	8 ms typically, configurable from 0.1 up to 32 ms	–
	signal voltage	24 V DC	–

AC500

Technical data

CANopen modules

Type	CI581-CN	CI582-CN
Outputs, single configurable as		
Possible configuration per AO	●	–
-10...+10 V	●	–
0...20 mA / 4...20 mA	●	–
Output		
resistance (load) when used as current output	0...500 Ω	–
loading capability when used as voltage output	±10 mA max.	–
Potential isolation		
Per module	●	●
Between fieldbus interface against the rest of the module	●	●
Between the channels		
input	–	–
output	–	–
Voltage supply for the module	By external 24 V DC voltage via terminal UP	
Process voltage UP		
Nominal voltage	24 V DC	
Current consumption on UP		
Min. (module alone)	0.260 A	
Max. (min. + loads)	0.260 A + load	
Reverse polarity protection	●	
Fuse for process voltage UP	10 A miniature fuse	
Approvals	See detailed page 248 or www.abb.com/plc	

AC500

Technical data

PROFINET IO RT device modules

Type	CI501-PNIO	CI502-PNIO	CI504-PNIO	CI506-PNIO
Communication interface				
Ethernet Interface				
Main protocol	PROFINET IO RT device			
ID Device configuration	By rotary switch on the front side, from 00h to FFh			
Ethernet connection on terminal units	2 x RJ45 with switch functionality for simple daisy chain on TU507-ETH or TU508-ETH or TU520-ETH			
Gateway Interface				
Gateway to	-	-	3 x RS232 / RS422 / RS485 ASCII serial interfaces	CAN / CANopen Master + 2 x RS232 / RS422 / RS485 ASCII serial interfaces
Fieldbus Protocol used	-	-	-	CAN 2A/2B Master - CANopen Master (1)
CAN physical interface	-	-	-	1 x 10 poles pluggable spring connector
Baudrate	-	-	-	Baudrate up to 1 MBit/s, Support for up to 126 CANopen Slaves
Serial interface				
Protocol used	-	-	3 x RS232 / RS422 or RS485	2 x RS232 / RS422 or RS485
Baudrate	-	-	Configurable from 300 bit/s to 115200 bit/s	
Fieldbus or serial connection on terminal units	-	-	3 x pluggable terminal blocks with spring on TU520-ETH	
Number of channels per module				
Digital	inputs	8	8	-
	outputs	8	8	-
Analog	inputs	4	-	-
	outputs	2	-	-
Digital configurable channels DC (configurable as inputs or outputs)		-	8	-
Additional configuration of channels as				
Fast counter (onboard I/O)		Configuration of max. 2 DI channels per module		
Occupies max. 1 DO or DC when used as counter		●	-	-
Connection				
Local I/O extension		●	●	●
Max. number of extension modules		max. 10 x S500 extension modules (standard or eCo modules allowed). Fast counter from digital IO modules can be also used.		
Via terminal unit TU5xx		●	●	●
Digital inputs				
Input	signal voltage	24 V DC		
	characteristic acc. to EN 61132-2	Type 1		
0 signal		-3...+5 V DC		
Undefined signal state		5...15 V DC		
1 signal		15...30 V DC		
Residual ripple, range for	0 signal	-3...+5 V DC		
	1 signal	15...30 V DC		
Input time delay (0 -> 1 or 1 -> 0)		8 ms typically, configurable from 0.1 up to 32 ms		
Digital outputs				
Transistor outputs 24 V DC, 0.5 A		●	-	-
Readback of output		-	● (on DC outputs)	-
Outputs, supplied via process voltage UP		●	-	-
Switching of 24 V load		●	-	-
Output voltage at signal state 1		Process voltage UP - 0.8 V		

(1) Not simultaneously.

AC500

Technical data

PROFINET IO RT device modules

Type	CI501-PNIO	CI502-PNIO	CI504-PNIO	CI506-PNIO
Output current				
Nominal current per channel	500 mA at UP = 24 V DC		–	–
Maximum (total current of all channels)	8 A		–	–
Residual current at signal state 0	< 0.5 mA		–	–
Demagnetization when switching off inductive loads	By internal varistors		–	–
Analog inputs AI				
	Max. number per module and with regard to the configuration: AIs / Measuring points			
Signal configuration per AI	4	–	–	–
0...10 V / -10... +10 V	4 / 4	–	–	–
0...20 mA / 4...20 mA	4 / 4	–	–	–
RTD using 2/3 wire needs 1/2 channel(s)	4 / 2	–	–	–
0...10 V using differential inputs, needs 2 channels	4 / 2	–	–	–
-10...+10 V using differential inputs, needs 2 channels	4 / 2	–	–	–
Digital signals (digital input)	4 / 4	–	–	–
Data when using the AI as digital input				
Input	time delay	8 ms typically, configurable from 0.1 up to 32 ms	–	–
	signal voltage	24 V DC	–	–
Outputs, single configurable as				
Possible configuration per AO	●	–	–	–
-10...+10 V	●	–	–	–
0...20 mA / 4...20 mA	●	–	–	–
Output	resistance (load) when used as current output	0...500 Ω	–	–
	loading capability when used as voltage output	±10 mA max.	–	–
Potential isolation				
Per module	●	●	●	●
Between Ethernet interface against the rest of the module	●	●	●	●
Voltage supply for the module	By external 24 V DC voltage via terminal UP			
Process voltage UP				
Nominal voltage	24 V DC			
Current consumption on UP				
	min. (module alone)	0.260 A	0.150 A	
	max. (min. + loads)	0.260 A + load	0.150 A	
Reverse polarity protection	●			
Fuse for process voltage UP	10 A miniature fuse			
Approvals	See detailed page 248 or www.abb.com/plc			

(1) Not simultaneously.

AC500

Technical data

EtherCAT modules

Type	CI511-ETHCAT	CI512-ETHCAT	
Communication interface			
Protocol	EtherCAT slave with CAM-Switch configurable function on the digital outputs		
ID Device configuration	Address is defined by position on Ethernet bus		
Field bus connection on TUs	2 x RJ45 with switch functionality for simple daisy chain on TU507-ETH or TU508-ETH		
Number of channels per module			
Digital	inputs	8	8
	outputs	8	8
Analog	inputs	4	-
	outputs	2	-
Digital configurable channels DC (configurable as inputs or outputs)	-	-	8
Additional configuration of channels as			
Fast counter (onboard I/O)	-	-	-
Occupies max. 1 DO or DC when used as counter	-	-	-
Connection			
Local I/O extension	●	-	-
Max. number of extension modules	max. 10 x S500 extension modules (standard or eCo modules allowed). Fast counter from digital IO modules can be also used.		
Via terminal unit TU5xx	●	-	-
Digital inputs			
Input signal voltage	24 V DC		
Input characteristic acc. to EN 61 132-2	Type 1		
0 signal	-3...+5 V DC		
Undefined signal state	5...15 V DC		
1 signal	15...30 V DC		
Residual ripple, range for	0 signal	-3...+5 V DC	
	1 signal	15...30 V DC	
Input time delay (0 -> 1 or 1 -> 0)	8 ms typically, configurable from 0.1 up to 32 ms		
Digital outputs			
Transistor outputs 24 V DC, 0.5 A	●	-	-
Readback of output	-	●	(on DC outputs)
Outputs, supplied via process voltage UP	●	-	-
Switching of 24 V load	●	-	-
Output voltage at signal state 1	Process voltage UP - 0.8 V		
Output current			
Nominal current per channel	500 mA at UP = 24 V DC		
Maximum (total current of all channels)	8 A		
Residual current at signal state 0	< 0.5 mA		
Demagnetization when switching off inductive loads	By internal varistors		
Analog inputs AI			Max. number per module and with regard to the configuration: AIs / Measuring points
Signal configuration per AI	4	-	-
0...10 V / -10 V... +10 V	4 / 4	-	-
0...20 mA / 4...20 mA	4 / 4	-	-
RTD using 2/3 wire needs 1/2 channel(s)	4 / 2	-	-
0...10 V using differential inputs, needs 2 channels	4 / 2	-	-
-10...+10 V using differential inputs, needs 2 channels	4 / 2	-	-
Digital signals (digital input)	4 / 4	-	-
Data when using the AI as digital input			
Input	time delay	8 ms typically, configurable from 0.1 up to 32 ms	-
	signal voltage	24 V DC	-

AC500

Technical data

EtherCAT modules

Type	CI511-ETHCAT	CI512-ETHCAT
Outputs, single configurable as:		
Possible configuration per AO	●	–
-10...+10 V	●	–
0...20 mA / 4...20 mA	●	–
Output resistance (load) when used as current output	0...500 Ω	–
Output loading capability when used as voltage output	±10 mA max.	–
Potential isolation		
Per module	●	●
Between Ethernet interface against the rest of the module	●	●
Between the channels		
input	–	–
output	–	–
Voltage supply for the module	By external 24 V DC voltage via terminal UP	
Process voltage UP		
Nominal voltage	24 V DC	
Current consumption on UP		
min. (module alone)	0.260 A	
max. (min. + loads)	0.260 A + load	
Reverse polarity protection	●	
Fuse for process voltage UP	10 A miniature fuse	
Approvals	See detailed page 248 or www.abb.com/plc	

AC500

Technical data

Modbus TCP modules

Type	CI521-MODTCP	CI522-MODTCP	
Communication interface			
Ethernet Interface			
Main protocol	Modbus TCP		
ID Device configuration	By rotary switch on the front side, from 00h to FFh		
Ethernet connection on terminal units	2 x RJ45 with switch functionality for simple daisy chain on TU507-ETH or TU508-ETH		
Number of channels per module			
Digital	inputs	8	8
	outputs	8	8
Analog	inputs	4	-
	outputs	2	-
Digital configurable channels DC (configurable as inputs or outputs)		-	8
Additional configuration of channels as			
Fast counter (onboard I/O)	Configuration of max. 2 DI channels per module		
Occupies max. 1 DO or DC when used as counter	●		
Connection			
Local I/O extension	●		
Max. number of extension modules	max. 10 x S500 extension modules (standard or eCo modules allowed). Fast counter from digital IO modules can be also used.		
Via terminal unit TU5xx	●	●	
Digital inputs			
Input	signal voltage	24 V DC	
	characteristic acc. to EN 61132-2	Type 1	
0 signal	-3...+5 V DC		
Undefined signal state	5...15 V DC		
1 signal	15...30 V DC		
Residual ripple, range for	0 signal	-3...+5 V DC	
	1 signal	15...30 V DC	
Input time delay (0 -> 1 or 1 -> 0)	8 ms typically, configurable from 0.1 up to 32 ms		
Digital outputs			
Transistor outputs 24 V DC, 0.5 A	●		
Readback of output	-	● (on DC outputs)	
Outputs, supplied via process voltage UP	●		
Switching of 24 V load	●		
Output voltage at signal state 1	Process voltage UP - 0.8 V		
Output current			
Nominal current per channel	500 mA at UP = 24 V DC		
Maximum (total current of all channels)	8 A		
Residual current at signal state 0	< 0.5 mA		
Demagnetization when switching off inductive loads	By internal varistors		
Analog inputs AI			Max. number per module and with regard to the configuration: AIs / Measuring points
Signal configuration per AI	4	-	
0...10 V / -10... +10 V	4 / 4	-	
0...20 mA / 4...20 mA	4 / 4	-	
RTD using 2/3 wire needs 1/2 channel(s)	4 / 2	-	
0...10 V using differential inputs, needs 2 channels	4 / 2	-	
-10...+10 V using differential inputs, needs 2 channels	4 / 2	-	
Digital signals (digital input)	4 / 4	-	

(1) Not simultaneously.

AC500

Technical data

Modbus TCP modules

Type		CI521-MODTCP	CI522-MODTCP
Data when using the AI as digital input			
Input	time delay	8 ms typically, configurable from 0.1 up to 32 ms	–
	signal voltage	24 V DC	–
Outputs, single configurable as			
Possible configuration per AO		•	–
-10...+10 V		•	–
0...20 mA / 4...20 mA		•	–
Output	resistance (load) when used as current output	0...500 Ω	–
	loading capability when used as voltage output	±10 mA max.	–
Potential isolation			
Per module		•	•
Between Ethernet interface against the rest of the module		•	•
Voltage supply for the module		By external 24 V DC voltage via terminal UP	
Process voltage UP			
Nominal voltage		24 V DC	
Current consumption on UP			
min. (module alone)		0.260 A	
max. (min. + loads)		0.260 A + load	
Reverse polarity protection		•	
Fuse for process voltage UP		10 A miniature fuse	
Approvals		See detailed page 248 or www.abb.com/plc	

(1) Not simultaneously.

AC500

Technical data

CS31 functionality

	AC500 CPU with integrated CS31 interface	S500 I/O with communication interface DC551-CS31 CI590-CS31-HA CI592-CS31
Master	Yes, at COM1	–
Slave	No	Yes / Redundant for CI590-CS31-HA
Protocols supported	ABB CS31 protocol	
Diagnosis		
Error indication	On LCD display of the CPU / AC500-eCo error LED	Via module LEDs
Online diagnosis	Yes	
Error code	Errors are recorded in the diagnosis system of the CPU	
Associated function blocks	Yes	
Physical layer		
Connection	Plug at COM1	Screw-type or spring-type terminals
Baud rate	187.5 kbit/s	
Distance	AC500-eCo: up to 50 m and up to 500 m using the isolator TK506 / AC500: up to 500 m; up to 2000 m using a repeater	
Max. number of modules on fieldbus	31 modules max. Please note: The CS31 bus interface occupies one or two module addresses (if counters are configured onboard or if the module is a mixed digital analog module). Depending on the configuration, or if the module contains also mixed digital analog I/O, connected extension modules can occupy further module addresses.	
Configuration		
Station address configuration	No	Using rotary switches (99 max.)

Digital and mixed signal I/O modules, “Fast Counter” operating modes. Not applicable for DC541 or eCo-I/O modules (1)

Operating mode, configured in the user program of the AC500	Occupied inputs DI or DC	Occupied outputs DO or DC	Maximum counting frequency kHz
0 No counter	0	0	–
1 One count-up counter with “end value reached” indication	1	1	50
2 One count-up counter with “enable” input and “end value reached” indication	2	1	50
3 Two up/down counters	2	0	50
4 Two up/down counters with 1 counting input inverted	2	0	50
5 One up/down counter with “dynamic set” input	2	0	50
6 One up/down counter with “dynamic set” input	2	0	50
7 One up/down counter with directional discriminator For synchro transmitters using two counting pulses with an offset of 90° (track A and B)	2	0	50
8 –	0	0	–
9 One up/down counter with directional discriminator and double evaluation For synchro transmitters using two counting pulses with an offset of 90° towards each other (track A and B)	2	0	30
10 One up/down counter with directional discriminator and fourfold evaluation For synchro transmitters using two counting pulses with an offset of 90° towards each other (track A and B)	2	0	15

(1) See technical documentation for details.

AC500

System data

Environmental Conditions

Process and supply voltages

24 V DC	Voltage	24 V (-15 %, +20 %)
	Protection against reverse polarity	yes

Allowed interruptions of power supply	DC supply	Interruption < 10 ms, time between 2 interruptions > 1 s, PS2
---------------------------------------	-----------	---

Important: Exceeding the maximum process and supply voltages could lead to unrecoverable damage of the system. The system could be destroyed. For the supply of the modules, power supply units according to PELV or SELV specifications must be used. The creepage distances and clearances meet the requirements of the overvoltage category II, pollution degree 2.

Assembly position

Horizontal	•
Vertical	•

Temperature

Operating	0 °C ... +60 °C	Preferred mounting position horizontal. Other mounting positions see manual.
Storage / Transport	-40 °C ... +70 °C	

Humidity

Operating / Storage	Max 95 % r. H. without condensation
---------------------	-------------------------------------

Air pressure

Operating	-1000 m ... 2000 m (1080 hPa ... 800 hPa)
Storage	<3500 m (>660 hPa)

Electromagnetic Compatibility

Radiated emission (radio disturbances)	Yes, Yes, in accordance with CISPR 16-2-3
Conducted emission (radio disturbances)	Yes, Yes, in accordance with CISPR 16-2-1, CISPR 16-1-2
Electrostatic discharge (ESD)	Yes, in accordance with IEC 61000-4-2, zone B, criterion B Electrostatic voltage in case of air discharge: 8 kV Electrostatic voltage in case of contact discharge: 6 kV
Fast transient interference voltages (burst)	Yes, in accordance with IEC 61000-4-4, zone B, criterion B Supply voltage units (DC): 2 kV Supply voltage units (AC): 2 kV Digital inputs/outputs (24 V DC): 1 kV Digital inputs/outputs (120...240 V AC): 2 kV Analog inputs/outputs: 1 kV Communication lines shielded: 1 kV I/O supply (DC-out): 2 kV
High energy transient interference voltages (surge)	Yes, in accordance with IEC 61000-4-5, zone B, criterion B Supply voltage units (DC): 1 kV CM* / 0.5 kV DM* Supply voltage units (AC): 2 kV CM* / 1 kV DM* Digital inputs/outputs (24 V DC): 1 kV CM* / 0.5 kV DM* Digital inputs/outputs (120...240 V AC): 2 kV CM* / 1 kV DM* Analog inputs/outputs: 1 kV CM* / 0.5 kV DM* Communication lines shielded: 1 kV CM* I/O supply (DC-out): 0,5 kV CM* / 0.5 kV DM* * CM = Common Mode, * DM = Differential Mode
Influence of radiated disturbances	Yes, in accordance with IEC 61000-4-3, zone B, criterion A Test field strength: 10 V/m
Influence of line-conducted interferences	Yes, in accordance with IEC 61000-4-6, zone B, criterion A Test voltage: 10 V
Influence of power frequency magnetic fields	Yes, in accordance with IEC 61000-4-8, zone B, criterion A 30 A/m 50 Hz 30 A/m 60 Hz

WARNING!

Risk of malfunctions and damages to persons!

Unused slots for communication modules are not protected against contact discharge. Dust and Dirt may cause contact problems and malfunctions.

Unused slots for Communication Modules must be covered with Dummy Communication Modules ("TA524 - Dummy Communication Module").

I/O-Bus connectors must not be touched during operation.

In order to prevent malfunctions, it is recommended that the operating personnel discharge themselves prior to touching communication connectors or perform other suitable measures to reduce effects of electrostatic discharges.

AC500

System data

Environmental Conditions

Environmental Tests

Storage	IEC 60068-2-1 Test Ab: cold withstand test -40 °C / 16 h IEC 60068-2-2 Test Bb: dry heat withstand test +70 °C / 16 h
Humidity	IEC 60068-2-30 Test Db: Cyclic (12 h / 12 h) Damp-Heat Test 55 °C, 93 % r. H. / 25 °C, 95 % r. H., 2 cycles
Vibration resistance	IEC 61131-2 / IEC 60068-2-6: 15 Hz ... 150 Hz, 1 g (with SD Memory Card inserted)
Shock resistance	IEC 60068-2-27: all 3 axes 15 g, 11 ms, half-sinusoidal

Mechanical Data

Wiring method	Spring terminals / Screw terminals	
Degree of protection	IP 20	
Assembly on DIN rail	DIN rail type	According to IEC 60715
		35 mm, depth 7.5 mm or 15 mm
Assembly with screws	Screw diameter	4 mm
	Fastening torque	1.2 Nm

Main dimensions mm, inches

Type	Nr communication modules	Length L	
		mm	inches
TB511-ETH	1	95.5	3.76
TB521-ETH / TB523-2ETH	2	123.5	4.86
TB541-ETH	4	179.5	7.07
TB5600-2ETH	0	67.5	2.66
TB5610-2ETH	1	95.5	3.76
TB5620-2ETH	2	123.5	4.86
TB5640-2ETH	4	179.5	7.07

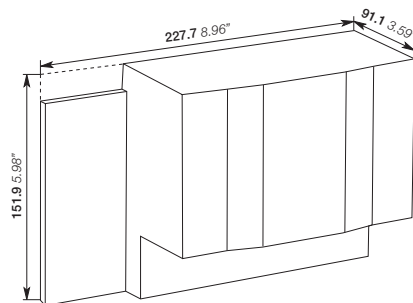
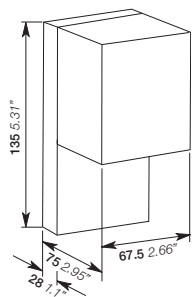
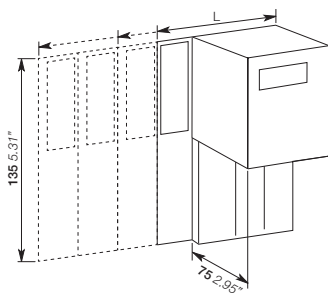

AC500-XC

PLC operating in eXtreme Conditions

133	Key features
134–144	Ordering data
145–171	Technical data
172–173	System data

79

ABB

PM592



SYS
BATT
I/O-Bus

ETH
FBP
COM1
COM2

run

PWR



RUN



ERR



WARNING
Use of
incorrect
battery may
cause fire or
explosion.

RUN
VAL
ESC
OK

DIAG
CFG





MC
502

← INSERT
→ PUSH

UP 24VDC 10W

CPU

05

AC500-XC

Key features



—

• Lower lifetime cost and many of the traditional practices are not required, such as: HVAC for the panel, shock absorbers, door sealing, etc...

—

• Resistance to:

- High humidity
- Salt mist
- Vibration
- High altitude
- Corrosive gases
- Temperature: from -40 to +70 °C

—

• All the benefits from AC500 range: Automation Builder engineering suite, I/O modules, scalable and flexible, same high performance communication, libraries and web services

AC500-XC

Ordering data

AC500 CPUs

- 2 internal serial interfaces, RS232 / RS485 configurable
- Display and 8 function keys for diagnosis and status
- Centrally expandable with up to 10 I/O modules (S500) for a total of 320 Digital I/Os or 160 Analog I/Os
- Simultaneous operation of up to 4 external communication modules in any desired combination
- Optional SD card for data storage and program backup
- Can also be used as slave for PROFIBUS DP, CANopen or PROFINET IO using CM582-DP-XC, CM588-CN-XC, CM589-PNIO-XC or CM589-PNIO-4-XC communication modules
- Ethernet version provides web server and IEC 60870-5-104 remote control protocol.

Program memory kB	Cycle time in μ s per instruction min. Bit/Word/Float. point	Integrated communication	Type	Order code	Price	Weight (1 pce) kg
512	0.06 / 0.09 / 0.7	Ethernet (1), 2 x serial	PM573-ETH-XC	1SAP330300R0271		0.150
512	0.05 / 0.06 / 0.5	2 x serial	PM582-XC	1SAP340200R0201		0.135
1024	0.05 / 0.06 / 0.5	Ethernet (1), 2 x serial	PM583-ETH-XC	1SAP340300R0271		0.150
4096	0.002 / 0.004 / 0.004	Ethernet (1), 2 x serial	PM591-ETH-XC	1SAP350100R0271		0.150
4096	0.002 / 0.004 / 0.004	Ethernet (1), 2 x serial	PM592-ETH-XC (2)	1SAP350200R0271		0.150



PM573-ETH-XC



PM592-ETH-XC

AC500 CPU PM595

- 2 Ethernet interfaces with integrated switch and software configurable protocol (PROFINET IO Controller, EtherCAT Master or Ethernet e.g. Modbus TCP client/server)
- 2 independent Ethernet interfaces for programming, online access, web server, ModbusTCP, IEC 60870-5-104 protocol e.g.
- 2 serial interfaces, RS232 / RS485 configurable
- Centrally expandable with up to 10 I/O modules (S500 and/or S500-eCo modules allowed)
- Simultaneous operation of up to 2 external communication modules in any desired combination, no need of additional terminal base

Program memory MB	Cycle time in μ s per instruction min. Bit/Word/Float. point	Integrated communication	Type	Order code	Price	Weight (1 pce) kg
16	0.0006/0.001/0.001	2 x Ethernet for Fieldbus (2 Ports switch), 2 x Ethernet (1), 2 x serial	PM595-4ETH-M-XC (2)	1SAP351500R0279		1.050

(1) Provides integrated web server and IEC 60870-5-104 remote control protocol on each interface independently.

(2) Provides integrated 4 GB flashdisk for user data storage and data logging.



PM595-4ETH-M-XC

AC500-XC

Ordering data

Terminal base

- For mounting and connection of the CPUs and communication modules, not needed for PM595
- 1 to 4 plug-in communication modules
- Connection for communication coupler integrated in the CPU
- I/O interface for direct connection of up to 10 expansion modules
- Connection COM1: 9-pole pluggable terminal block
- Connection COM2: D-Sub 9 (socket).

Number of coupler slots	Connection for coupler integrated in the CPU	Type	Order code	Price	Weight (1 pce) kg
1	Ethernet RJ45	TB511-ETH-XC	1SAP311100R0270		0.215
2	Ethernet RJ45	TB521-ETH-XC	1SAP312100R0270		0.215
4	Ethernet RJ45	TB541-ETH-XC	1SAP314100R0270		0.215



TB511-ETH-XC



TB541-ETH-XC

AC500-XC

Ordering data

AC500 Condition Monitoring CMS-XC

- PLC integrated condition monitoring and fast protection for high frequency signals (vibration, current, voltage, speed/encoder)
- FM502-CMS module needs function module terminal base TF5x1 for direct interfacing to CPU, communication couplers, other I/O
 - for stand-alone or control/safety integrated condition monitoring
- PM592 CPU to be used on same TF5x1 for data storage and signal processing or communication
 - C-code interface for own complex diagnosis algorithms, 4GB Flash disk for raw fingerprints and indicator trending
- FM502-CMS module:
 - 16 fast, precise analog inputs, all synchronously sampled; configurable as IEPE or +-10V
 - individual measurement configuration (start, stop, trigger) per channel
 - per channel up to 50ksamples/s and 24bit ADC resolution, adjustable sampling
 - encoder inputs (5V or 24V) up to 300kHz counter; 12 modes, incl. absolute SSI (1MHz)
 - fast data logging, compact WAV-Files delivered automatically to CPU, incl. synchronized encoder signal if configured
 - analogue values always available for fast protection in I/O image of CPU
- Included in Automation Builder: Configuration, libraries for CMS control and wav file handling, examples
- Available download package: Signal processing library, example programs with simple diagnosis, logging and automated triggering (2)

Number of coupler slots	Description	Type	Order code	Price	Weight (1 pce) kg
n.a.	Function Module for Condition Monitoring Systems, 16AI, 2DI, 2DC, 1x Encoder (A, B, Z)	FM502-CMS-XC	1SAP460400R0001		0.215
0	Function module terminal base for FM502, no coupler slots, 1x ETHERNET, 1x serial, spring terminals, 24 V DC	TF501-CMS-XC (1)	1SAP317000R0271		0.350
2	Function module terminal base for FM502, 2x coupler slots, 1x ETHERNET, 1x serial, spring terminals, 24 V DC	TF521-CMS-XC (1)	1SAP317200R0271		0.400

(1) Can only be used together with FM502 and PM592-ETH

(2) Download of Package under "Application Examples" at www.abb.com/plc



FM502-CMS-XC



TF501-CMS-XC



TF521-CMS-XC

AC500-XC

Ordering data

AC500-XC V3 CPUs (2)

- 1x internal serial interface, RS232 / RS485 configurable (ACSII or Modbus RTU Master/Slave)
- 2x independant Ethernet interfaces which can also be used as switch and software configurable protocols like ModbusTCP, MQTT, PROFINET IO Controller (2)(3), Ethernet IP Adapter (2)(3), EtherCAT Master (2)(3), IEC60870-5-104 or IEC61850 (3)
- Web server with WebVisu HTML5 for use with CP600 with Web interface
- 1x internal CAN interface, with CANopen Master/Slave (2), CAN 2A/2B and J1939 protocols
- Display and 8 function keys for diagnosis and status
- Centrally expandable with up to 10 I/O modules, 320 I/Os (S500 and/or S500-eCo modules allowed)
- Simultaneous operation of several external communication modules in any desired combination
- To be used exclusively with new TB56xx-2ETH
- Optional SD card for data storage and program backup
- To be used only with Automation Builder 2.x

Program / Data memory MB	Cycle time in μ s per instruction min. Bit/Word/Float. point	Integrated communication	Type	Order code	Price	Weight (1 pce) kg
8	0.020 / 0.020 / 0.120	2 x Ethernet with configurable protocols PROFINET IO Controller (2)(3) / EtherCAT Master (2)(3) or EthernetIP (2)(3), 1 x serial, 1x CAN interface	PM5630-2ETH-XC (1) (4)	1SAP331000R0278		0.135
80	0.010 / 0.010 / 0.010	2 x Ethernet with configurable protocols PROFINET IO Controller (2)(3) / EtherCAT Master (2)(3) or EthernetIP (2)(3), 1 x serial, 1x CAN interface	PM5650-2ETH-XC (1) (4)	1SAP341000R0278		0.135
160	0.002 / 0.002 / 0.002	2 x Ethernet with configurable protocols PROFINET IO Controller (2) / EtherCAT Master (2) or EthernetIP (2)(3), 1 x serial, 1x CAN interface	PM5670-2ETH-XC (1) (4)	1SAP351000R0278		0.135
160 / 8GB Flash disk	0.002 / 0.002 / 0.002	2 x Ethernet with configurable protocols PROFINET IO Controller (2) / EtherCAT Master (2) or EthernetIP (2)(3), 1 x serial, 1x CAN interface	PM5675-2ETH-XC (1) (4)	1SAP351500R0278		0.150

(1) Ethernet communication provides integrated web server, IEC 60870-5-104 remote control protocol and OPC UA Server on each interface independently.

(2) In development, availability on demand

(3) Some communication protocols are licensed see following lines

(4) Only to be used with dedicated terminal base TB56xx-2ETH-XC



PM5650-2ETH-XC

Feature licenses

Some HW or FW features need to be licensed to be used on the new CPU. Which allows:

- more flexibility
- better adaptation to the needs

AC500-XC

Ordering data

AC500-XC V3 Terminal base

- For mounting and connection of the AC500-XC V3 CPUs only and communication modules
- 0, 1, 2, 4 or up to 6 plug-in communication modules
- Connection for communication coupler integrated in the CPU
- I/O interface for direct connection of up to 10 expansion modules
- Connection COM1: 9-pole pluggable spring terminal block
- Connection CAN: 2x 5-pole pluggable spring terminal block
- 2x RJ45 Ethernet interfaces with configurable switch functionality

Number of coupler slots	Connection for coupler integrated in the CPU	Type	Order code	Price	Weight (1 pce) kg
0	2x RJ45 for Ethernet, 1x serial COM1 with pluggable spring connector and 1x2x5 poles pluggable spring connector for CAN/CANopen interface	TB5600-2ETH-XC	1SAP310300R0278		0.165
1		TB5610-2ETH-XC	1SAP311300R0278		0.190
2		TB5620-2ETH-XC	1SAP312300R0278		0.215
4		TB5640-2ETH-XC	1SAP314300R0278		0.265
6		TB5660-2ETH-XC	1SAP316300R0278		0.315



TB5600-2ETH-XC



TB5610-2ETH-XC



TB5620-2ETH-XC



TB5640-2ETH-XC

AC500-XC

Ordering data

Communication modules

Protocol	Connections	CPU V3 Support	Type	Order code	Price	Weight (1 pce) kg
PROFIBUS DP V0/V1 master	D-Sub 9	-	CM592-DP-XC	1SAP373200R0001		0.115
PROFIBUS DP V0/V1 slave	D-Sub 9	-	CM582-DP-XC	1SAP372200R0001		0.115
Ethernet (TCP/IP, UDP/IP, Modbus TCP)	2 x RJ45 - integrated switch	-	CM597-ETH-XC	1SAP373700R0001		0.115
CANopen master	Terminal block 2 x 5 poles spring	(1)	CM598-CN-XC	1SAP373800R0001		0.115
CANopen slave	Terminal block 2 x 5 poles spring	-	CM588-CN-XC	1SAP372800R0001		0.115
PROFINET I/O RT controller	2 x RJ45 - integrated switch	Yes	CM579-PNIO-XC	1SAP370901R0101		0.115
PROFINET I/O RT device	2 x RJ45 - integrated switch	(2)	CM589-PNIO-XC	1SAP372900R0011		0.115
PROFINET IO RT with 4 devices	2xRJ45 - integrated switch	(2)	CM589-PNIO-4-XC	1SAP372900R0111		0.115

(1) Only with CAN 2A/2B protocol

(2) In preparation



CM592-DP-XC



CM579-PNIO-XC

I/O modules

- Hot swap capable when mounted on hot swap terminal unit
- For central expansion of the AC500-XC CPU
- For decentralized expansion in combination with communication interface module (not for DC505-FBP)
- DC and AC: channels can be configured individually as inputs or outputs
- Terminal unit required (refer to table below).

Digital I/O

Number of	Input signal	Output type	Output signal	Terminal units	Type	Order code	Price	Weight (1 pce) kg
DI/DO/DC								
32 / - / -	24 V DC	-	-	TU516-XC	DI524-XC	1SAP440000R0001		0.200
- / - / 16	24 V DC	Transistor	24 V DC, 0.5 A	TU516-XC	DC522-XC	1SAP440600R0001		0.200
- / - / 24	24 V DC	Transistor	24 V DC, 0.5 A	TU516-XC	DC523-XC	1SAP440500R0001		0.200
16 / - / 16	24 V DC	Transistor	24 V DC, 0.5 A	TU516-XC	DC532-XC	1SAP440100R0001		0.200
- / 32 / -	-	Transistor	24 V DC, 0.5 A	TU516-XC	DO524-XC	1SAP440700R0001		0.200
8 / 8 / -	24 V DC	Relay	230 V AC, 3 A (1)	TU532-XC	DX522-XC	1SAP445200R0001		0.200
- / 8 / -	-	Transistor	24 V DC, 2 A	TU542-XC	DO526-XC	1SAP440800R0001		0.200

(1) Relay outputs, changeover contacts.



DI524-XC



DO524-XC

AC500-XC

Ordering data

Analog I/O

Number of	Input signal	Output signal	Terminal units	Type	Order code	Price	Weight (1 pce) kg
AI/AO							
16 / 0	0...10 V, ±10 V 0/4...20 mA	–	TU516-XC	AI523-XC	1SAP450300R0001		0.200
4 / 4	PT100, PT1000, Ni1000	±10 V	TU516-XC	AX521-XC	1SAP450100R0001		0.200
8 / 8 (max. 4 current outputs)		0/4...20 mA	TU516-XC	AX522-XC	1SAP450000R0001		0.200
0 / 16 (max. 8 current outputs)	–		TU516-XC	AO523-XC	1SAP450200R0001		0.200
8 / 0	0...5 V, 0...10 V, ±50 mV, ±500 mV, 1 V, ±5 V, ±10 V, 0/4...20 mA, ±20 mA PT100, PT1000, Ni1000, Cu50, 0...50 kΩ, S, T, N, K, J	–	TU516-XC	AI531-XC	1SAP450600R0001		0.200

Analog/digital mixed I/O

Number of	Input signal	Output type	Output signal	Terminal unit	Type	Order code	Price	Weight (1 pce) kg
AI/AO/DI/DO/DC								
4 / 2 / 16 / - / 8	24 V DC, 0...10 V, ±10 V, 0/4...20 mA, PT100,	Transistor	24 V DC, 0.5 A ±10 V,	TU516-XC	DA501-XC	1SAP450700R0001		0.200
4 / 2 / - / 16 / 8	PT1000, Ni100, Ni1000		0/4...20 mA	TU516-XC	DA502-XC (1)	1SAP450800R0001		0.200

(1) In preparation

Multifunctional module

- Not hot swap capable

Functionality	Number of	Input signal	Output type	Output signal	Terminal unit	Type	Order code	Price	Weight (1 pce) kg
DI/DO/DC									
Encoder and PWM module	2 / - / 8	24 V DC and 2 encoder inputs	2 PWM outputs	–	TU516-XC	CD522-XC	1SAP460300R0001		0.125

Fast I/O module for direct mounting on the terminal base of the AC500 CPU

Functionality	Number of	Input signal	Output type	Output signal	Terminal unit	Type	Order code	Price	Weight (1 pce) kg
DI/DO/DC									
Interrupt I/O and fast counter	- / - / 8	24 V DC	Transistor	24 V DC, 0.5 A	N/A (2)	DC541-CM-XC (1)	1SAP470000R0001		0.100

(1) Multifunctional module, refer to table on page 157 for details. Terminal block for I/O signal connection included.

(2) Occupies a communication module slot.



AI523-XC



AI531-XC



DA501-XC



CD522-XC



DC541-CM-XC

AC500-XC

Ordering data

Communication interface modules

Number of	Input signal	Output type	Output signal	Terminal units	Type	Order code	Price	Weight (1 pce) kg
AI/AO/DI/DO/DC								
For CS31-Bus								
- / - / 8 / - / 16	24 V DC	Transistor	24 V DC, 0.5 A	TU552-CS31-XC	DC551-CS31-XC	1SAP420500R0001		0.200
- / - / - / - / 16	24 V DC	Transistor	24 V DC, 0.5 A	TU552-CS31-XC	CI590-CS31-HA-XC	1SAP421100R0001		0.200
4 / 2 / 8 / - / 8	24 V DC / 0...10 V, -10...+10 V, 0...20 mA, 4...20 mA, PT100, PT1000, Ni100, Ni1000	Transistor	24 V DC, 0.5 A / -10...+10 V, 0...20 mA, 4...20 mA	TU552-CS31-XC	CI592-CS31-XC	1SAP421200R0001		0.200
For PROFIBUS-DP								
4 / 2 / 8 / 8 / -	24 V DC / 0...10 V, -10...+10 V, 0...20 mA, 4...20 mA, PT100, PT1000, Ni100, Ni1000	Transistor	24 V DC, 0.5 A / -10...+10 V, 0...20 mA, 4...20 mA	TU510-XC / TU518-XC	CI541-DP-XC	1SAP424100R0001		0.200
- / - / 8 / 8 / 8	24 V DC	Transistor	24 V DC, 0.5 A	TU510-XC / TU518-XC	CI542-DP-XC	1SAP424200R0001		0.200
For CANopen								
4 / 2 / 8 / 8 / -	24 V DC / 0...10 V, -10...+10 V, 0...20 mA, 4...20 mA, PT100, PT1000, Ni100, Ni1000	Transistor	24 V DC, 0.5 A / -10...+10 V, 0...20 mA, 4...20 mA	TU510-XC / TU518-XC	CI581-CN-XC	1SAP428100R0001		0.200
- / - / 8 / 8 / 8	24 V DC	Transistor	24 V DC, 0.5 A	TU510-XC / TU518-XC	CI582-CN-XC	1SAP428200R0001		0.200
For Ethernet based protocol - PROFINET IO RT								
4 / 2 / 8 / 8 / -	24 V DC / 0...10 V, -10...+10 V, 0...20 mA, 4...20 mA, PT100, PT1000, Ni100, Ni1000	Transistor	24 V DC, 0.5 A / -10...+10 V, 0...20 mA, 4...20 mA	TU508-ETH-XC	CI501-PNIO-XC	1SAP420600R0001		0.200
- / - / 8 / 8 / 8	24 V DC	Transistor	24 V DC, 0.5 A	TU508-ETH-XC	CI502-PNIO-XC	1SAP420700R0001		0.200
For Ethernet based protocol - Modbus TCP								
4 / 2 / 8 / 8 / -	24 V DC / 0...10 V, -10...+10 V, 0...20 mA, 4...20 mA, PT100, PT1000, Ni100, Ni1000	Transistor	24 V DC, 0.5 A / -10...+10 V, 0...20 mA, 4...20 mA	TU508-ETH-XC	CI521-MODTCP-XC	1SAP422100R0001		0.200
- / - / 8 / 8 / 8	24 V DC	Transistor	24 V DC, 0.5 A	TU508-ETH-XC	CI522-MODTCP-XC	1SAP422200R0001		0.200

From	To	Output signal	Terminal units	Type	Order code	Price	Weight (1 pce) kg
Gateway for Ethernet based protocol - PROFINET IO RT							
PROFINET I/O	-	3 x RS232/485 ASCII serial interfaces	TU520-ETH-XC	CI504-PNIO-XC	1SAP421300R0001		0.200
PROFINET I/O	1 x CAN 2A/2B or CANopen Master	2 x RS232/485 ASCII serial interfaces	TU520-ETH-XC	CI506-PNIO-XC	1SAP421500R0001		0.200



DC551-CS31-XC



CI541-DP-XC



CI581-CN-XC



CI502-PNIO-XC



CI506-PNIO-XC



CI521-MODTCP-XC

AC500-XC

Ordering data

Hot swap terminal units

For loadless hot swapping of digital and analog expansion modules, when used in configurations with communication interface modules or AC500 CPU supporting hot swap. Hot swapping of attached expansion module mounted on hot swap terminal unit is supported by AC500 V3 CPU modules as of PM5630-2ETH, AC500 V2 CPU modules as of PM585-ETH, CI501-PNIO, CI502-PNIO, CI541-DP, CI542-DP, CI521-MODTCP and CI522-MODTCP. AC500-S safety I/O modules cannot be used in configurations containing hot swap terminal units. Mixed configurations of hot swap terminal units with normal terminal units for digital and analog expansion modules are possible. In the installation hot swap terminal units can be identified by the word Hot Swap and a white frame around the connection terminal area.

For	Supply	Connection type	Type	Order code	Price	Weight (1 pce) kg
I/O modules - for Hot Swap (2)	24 V DC	Spring	TU516-H-XC	1SAP415000R0001		0.300
I/O modules AC / Relay - for Hot Swap (2)	230 V AC	Spring	TU532-H-XC	1SAP415100R0001		0.300
I/O module DO526-XC - for Hot Swap (2)	24 V DC	Spring	TU542-H-XC	1SAP415200R0001		0.300

(1) TU518-XC Terminal units can also be used with PROFIBUS DP CI modules with baud rate up to 1Mbaud.

(2) I/O module as of index F0 needed for Hot Swap

Terminal units

For digital and analog expansion modules and interface modules. Please note: for modules with relay outputs, terminal units for 230 V AC (TU532-XC) is required.

For	Supply	Connection type	Type	Order code	Price	Weight (1 pce) kg
Ethernet interface modules	24 V DC	Spring	TU508-ETH-XC	1SAP414000R0001		0.300
CANopen/PROFIBUS DP interface modules	24 V DC	Spring	TU510-XC	1SAP410800R0001		0.300
I/O modules	24 V DC	Spring	TU516-XC	1SAP412000R0001		0.300
CANopen/PROFIBUS DP interface modules	24 V DC	Spring	TU518-XC (1)	1SAP411200R0001		0.300
Ethernet gateway modules	24 V DC	Spring	TU520-ETH-XC	1SAP414400R0001		0.300
I/O modules AC / Relay	230 V AC	Spring	TU532-XC	1SAP417000R0001		0.300
I/O module DO526-XC	24 V DC	Spring	TU542-XC	1SAP413200R0001		0.300
CS31 interface modules	24 V DC	Spring	TU552-CS31-XC	1SAP410400R0001		0.300

(1) TU518-XC Terminal units can also be used with PROFIBUS DP CI modules with baud rate up to 1Mbaud.

(2) I/O module as of index F0 needed for Hot Swap



TU516-XC



TU520-ETH-XC



TU510-XC



TU508-ETH-XC



TU516-H-XC

AC500-XC

Ordering data

Terminal units compatibility

Type	For I/O modules			For communication interface modules				
	TU516-XC TU516-H-XC	TU532-XC TU532-H-XC	TU542-XC TU542-H-XC	TU508-ETH-XC	TU510-XC	TU518-XC	TU520-ETH-XC	TU552-CS31-XC
DA501-XC	•							
DA502-XC	•							
DC522-XC	•							
DC523-XC	•							
DC532-XC	•							
DI524-XC	•							
DO524-XC	•							
DO526-XC			•					
DX522-XC		•						
CD522-XC	• (2)							
AI523-XC	•							
AI531-XC	•							
AO523-XC	•							
AX521-XC	•							
AX522-XC	•							
DC551-CS31-XC								•
CI590-CS31-HA-XC								•
CI592-CS31-XC								•
CI501-PNIO-XC				•				
CI502-PNIO-XC				•				
CI504-PNIO-XC							•	
CI506-PNIO-XC							•	
CI521-MODTCP-XC				•				
CI522-MODTCP-XC				•				
CI541-DP-XC					•	• (1)		
CI542-DP-XC					•	• (1)		
CI581-CN-XC						•		
CI582-CN-XC						•		

(1) Can be used with baudrate up to 1Mbaud.

(2) CD522-XC cannot be used on TU516-H-XC.

AC500-XC

Ordering data

Accessories for AC500-XC

For	Description	Type	Order code	Price	Weight (1 pce) kg
AC500 CPUs COM1	Programming cable Sub-D / terminal block, length 5 m	TK502	1SAP180200R0101		0.400
AC500 CPUs COM2	Programming cable Sub-D / Sub-D, length 5 m	TK501	1SAP180200R0001		0.400
AC500 CPUs	Memory card (2 GB SD card)	MC502	1SAP180100R0001		0.020
	Lithium battery for data buffering	TA521	1SAP180300R0001		0.100
I/O modules	Pluggable marker holder for I/O modules, packing unit includes 10 pcs. Template available in the AC500 online help	TA523	1SAP180500R0001		0.300
AC500 CPU's, interface module, communication module and I/O modules	White labels, packing unit includes 10 pcs	TA525	1SAP180700R0001		0.100
Terminal base	Communication Module, blind cap	TA524	1SAP180600R0001		0.120
CPU terminal base	Accessories for wall mounting, packing unit includes 10 pcs	TA526	1SAP180800R0001		0.200
	5-pole power plug for AC500. Spare part. Can be plugged to CPU terminal base TB5x1. Packing unit includes 5 pcs	TA527	1SAP181100R0001		0.200
	9-pole COM1 plug for AC500. Spare part. Can be plugged to CPU terminal base TB5x1 or on TU520-ETH-XC. Packing unit includes 5 pcs	TA528	1SAP181200R0001		0.200
Communication modules	9-pole spring plug for CM574-RS/RCOM. Spare part. Packing unit includes 10 pcs	TA532	1SAP182000R0001		
	5-pole spring plug for CM575-DN/CM578-CN. Spare part. Packing unit includes 5 pcs	TA533	1SAP182100R0001		
	2x5-pole spring plug for CM588-CN and CM598-CN. Spare part. Packing unit includes 5 pcs.	TA534	1SAP182200R0001		
	10-pole spring plug for DC541-CM. Spare part. Packing unit includes 10 pcs.	TA536	1SAP183100R0001		
Protective caps for TB, TU and CM	10 x Sub-D plastic caps 20 x RJ45 plastic caps, 3 x RJ45 female 10 x M12 plastic caps	TA535	1SAP182300R0001		0.300
AC500 CPUs PM595	Protective cap, spare-parts, Packing unit includes 3 pcs	TA540	1SAP182600R0001		0.200
	Lithium battery for real-time-clock buffering	TA541	1SAP182700R0001		0.030
	Accessories for screw-mounting, Packing unit includes 20 pcs	TA543	1SAP182800R0001		0.100



MC502

AC500-XC

Technical data

AC500-XC CPUs

Type	PM573-ETH-XC	PM582-XC	PM583-ETH-XC
Supply voltage	24 V DC		
Current consumption on 24 V DC			
Min. (module alone)	0.110 A	0.050 A	0.110 A
Max. (all couplers and I/Os)	0.810 A	0.750 A	0.810 A
User program memory - Flash EPROM and RAM	512 kB	512 kB	1024 kB
Integrated user data memory	512 kB thereof 288 kB saved	416 kB thereof 288 kB saved	1024 kB thereof 288 kB saved
User Flashdisk (Data-storage, program access or also external with FTP)	-		
Plug-in memory card	depending on SD-Card used: no SD-HC card allowed, use MC502 accessory		
Web server's data for user RAM disk	1 024 kB	-	4 096 kB
Data buffering	battery		
Real-time clock (with battery back-up)	●		
Cycle time for 1 instruction (minimum)			
Binary	0.06 μs	0.05 μs	
Word	0.09 μs	0.06 μs	
Floating-point	0.7 μs	0.5 μs	
Max. number of centralized inputs/outputs			
Max. number of extension modules on I/O bus	up to max. 10 (S500 allowed)		
Digital	inputs / outputs 320 / 320		
Analog	inputs / outputs 160 / 160		
Max. number of decentralized inputs/outputs	depends on the used standard Fieldbus (1)		
Program execution			
Cyclical / Time controlled / Multi tasking	● / ● / ●		
User program protection by password	●		
Internal interfaces			
COM1			
RS232 / RS485 configurable	●		
Connection (on terminal bases)	pluggable spring terminal block, use TK502 cable in accessory		
Programming, Modbus RTU, ASCII, CS31 master	●		
COM2			
RS232 / RS485 configurable	●		
Connection (on terminal bases)	D-Sub 9 female, use TK501 cable in accessory		
Programming, Modbus RTU, ASCII	●		
FieldBusPlug			
Serial neutral interface	●		
Connection (on terminal bases)	M12 male, 5 pole		
Functions	programming cable UTF-21-FBP, slave communication depending on FieldBusPlug used (PROFIBUS DP, CANopen, DeviceNet)		
Ethernet			
Ethernet connection (on terminal bases)	RJ45	-	RJ45
Ethernet functions: online Access, ICMP (Ping), DHCP, IP configuration protocol, UDP data exchange, Modbus TCP, HTTP (integrated Web server), IEC60870-5-104 remote control protocol, MQTT, SNTP (Time synchronization), FTP server, SMTP client, Socket programming	●	-	●
Ethernet based Fieldbus			
Ethernet connection (on CPU module)	-		
Downloadable protocols like: PROFINET IO RT Controller / Device (2) EtherCAT Master	-		
CPU Display	LC display and 8 function keys		
Function	RUN / STOP, status, diagnosis		
RUN / STOP, RESET push buttons	-		
LEDs for various status display	-		
Timers / Counters	unlimited / unlimited		
Approvals	See detailed page 248 or www.abb.com/plc		

(1) e.g. CS31 Fieldbus: up to 31 stations with up to 120 DIs / 120 DOs or up to 32 AIs / 32 AOs per station.

(2) Availability on demand

AC500-XC

Technical data

AC500-XC CPUs

Type	PM591-ETH-XC	PM592-ETH-XC	PM595-4ETH-M-XC
Supply voltage	24 V DC		
Current consumption on 24 V DC			
Min. (module alone)	0.150 A		0.400 A
Max. (all couplers and I/Os)	0.850 A		1.2 A
User program memory - Flash EPROM and RAM	4096 kB		16384 kB
Integrated user data memory	5632 kB thereof 1536 kB saved		16384 kB thereof 3072 kB saved
User Flashdisk (Data-storage, program access or also external with FTP)	-		Yes, 4 GB Flash non removable
Plug-in memory card	depending on SD-Card used: no SD-HC card allowed, use MC502 accessory		
Web server's data for user RAM disk	8 MB		32 MB
Data buffering	battery		no battery needed
Real-time clock (with battery back-up)	●		
Cycle time for 1 instruction (minimum)			
Binary	0.002 μs		0.0006 μs
Word	0.004 μs		0.001 μs
Floating-point	0.004 μs		0.001 μs
Max. number of centralized inputs/outputs			
Max. number of extension modules on I/O bus	up to max. 10 (S500 allowed)		
Digital	inputs / outputs		320 / 320
Analog	inputs / outputs		160 / 160
Max. number of decentralized inputs/outputs	depends on the used standard Fieldbus (1)		
Program execution			
Cyclical / Time controlled / Multi tasking	● / ● / ●		
User program protection by password	●		
Internal interfaces			
COM1			
RS232 / RS485 configurable	●		
Connection (on terminal bases)	pluggable spring terminal block, use TK502 cable in accessory		
Programming, Modbus RTU, ASCII, CS31 master	●		
COM2			
RS232 / RS485 configurable	●		
Connection (on terminal bases)	D-sub 9 female, use TK501 cable in accessory		
Programming, Modbus RTU, ASCII	●		
FieldBusPlug			
Serial neutral interface	●		-
Connection (on terminal bases)	M12 male, 5 pole		-
Functions	programming cable UTF-21-FBP, slave communication depending on FieldBusPlug used (PROFIBUS DP, CANopen, DeviceNet)		
Ethernet			
Ethernet connection (on terminal bases)	RJ45	RJ45	2x RJ45
Ethernet functions: online Access, ICMP (Ping), DHCP, IP configuration protocol, UDP data exchange, Modbus TCP, HTTP (integrated Web server), IEC60870-5-104 remote control protocol, MQTT, SNTP (Time synchronization), FTP server, SMTP client, Socket programming	●	●	●
Ethernet based Fieldbus			
Ethernet connection (on CPU module)	-		4 x RJ45 (2x interfaces with 2-port switch)
Downloadable protocols like: PROFINET IO RT Controller / EtherCAT Master or Ethernet e.g. Modbus TCP client/server	-		●
CPU display	LC display and 8 function keys		-
Function	RUN / STOP, status, diagnosis		Status, diagnosis
RUN / STOP, RESET push buttons	-		●
LEDs for various status display	-		●
Timers / Counters	unlimited / unlimited		
Approvals	See detailed page 248 or www.abb.com/plc		

(1) e.g. CS31 Fieldbus: up to 31 stations with up to 120 DI/ 120 DOs or up to 32 AI/ 32 AO per station.

AC500-XC

Technical data

AC500-XC V3 CPUs

Type	PM5630-2ETH-XC	PM5650-2ETH-XC	PM5670-2ETH-XC	PM5675-2ETH-XC
Supply voltage	24 V DC			
Current consumption on 24 V DC				
Min. typ. (module alone)	0.150 A	0.200 A	0.250 A	0.250 A
Max. typ. (all couplers and I/Os)	0.850 A	0.900 A	0.950 A	0.950 A
User program memory / User Data memory	8 MB	80 MB	160 MB	160 MB
Web server's data – Flash EPROM and DRAM				
User data memory saved	256 KB	256 KB	1.5 MB	1.5 MB
User Flashdisk (Data-storage, programm access or also external with FTP)				8 GB Flash non removable
Plug-in memory card	Depending on SD-Card used: SD-HC card allowed, use MC502 preferably accessory			
Web server's data for user RAM disk	8 MB	No limitation, included into the global User Program/Data memory		
Data buffering	battery			
Real-time clock (with battery back-up)	●			
Cycle time for 1 instruction (minimum)				
Binary	0.02 μs	0.01 μs	0.002 μs	0.002 μs
Word	0.02 μs	0.01 μs	0.002 μs	0.002 μs
Floating-point	0.12 μs	0.01 μs	0.002 μs	0.002 μs
Communication modules supported				
Max. number of communication modules on TBs	up to 2	Up to 6 depending on available terminal bases (2)		
Type of communication module supported	CM579-PNIO-XC, CM589-PNIO-XC, CM589-PNIO-4-XC, CM582-DP-XC (2), CM592-DP-XC (2), CM597-ETH-XC (2) and CM598-CN-XC (2)			
Max. number of centralized inputs/outputs				
Max. number of extension modules on I/O bus	up to max. 10 (S500 and/or S500-eCo modules allowed)			
Digital inputs/outputs	320/320			
Analog inputs/outputs	160/160			
Max. number of decentralized inputs/outputs	depends on the used standard Fieldbus (1)			
Program execution				
Cyclical / Time controlled / multi tasking	●/●/●			
User program protection by password	●			
Internal interfaces				
COM1				
RS232 / RS485 configurable	●			
Connection (on terminal bases or CPU module)	pluggable spring terminal block, use TK502 cable in accessory			
Modbus RTU Master/Slave, ASCII	●			
CANopen				
Serial interface	CAN serial interface			
Connection (on terminal bases)	Pluggable spring terminal block, 2x 5 poles			
Functions	CANopen Master / Slave (2) communication, CAN 2A/2B, J1939 protocol			

(1) e.g. CANopen Fieldbus: up to 127 stations with up to 320 Digital channels or up to 160 Analog channels per station.

(2) In preparation, availability on demand

(3) Feature is licensed

AC500-XC

Technical data

AC500-XC V3 CPUs

Type	PM5630-2ETH-XC	PM5650-2ETH-XC	PM5670-2ETH-XC	PM5675-2ETH-XC
Ethernet	2x independent Ethernet interfaces for several uses			
Ethernet connection (on terminal bases)	2x RJ45 with 2x separated interfaces and MAC-Address, could be used as 2-port switch with 1x interface			
Ethernet functions:				
Online Access, ICMP (Ping), DHCP	●			
IP configuration protocol	●			
UDP data exchange, Network variables	●			
Modbus TCP Client / Server	●			
IEC60870-5-104 remote control protocol	●			
HTTP / HTTPs (integrated Web server)	●			
SNTP (Time synchronization)	●			
FTP / FTPs server	●			
SMTP client	●			
Socket programming	●			
WebVisu for data visualisation on webserver HTML5	●			
Valid for all CPU before OPC UA MQTT	●			
OPC UA server (Micro Embedded Device Server) with security	●			
Ethernet Switch on ETH1 / ETH2	●			
Ethernet based Fieldbus				
Downloadable protocols (licensed feature):	available on one Ethernet interface, the other interface can be sometimes used as switch			
IEC 61850 server	● (3)	● (3)	● (3)	● (3)
PROFINET IO RT Controller	● (2)(3)	● (2)(3)	● (2)	● (2)
EtherCAT Master	● (2)(3)	● (2)(3)	● (2)	● (2)
EthernetIP Adapter	● (2)(3)	● (2)(3)	● (2)(3)	● (2)(3)
CPU display	LC display and 8 function keys			
Function	RUN / STOP, status, diagnosis			
LEDs for various status display	●			
Timer/Counter	unlimited/unlimited			
Approvals	See detailed page 248 or www.abb.com/plc			

(1) e.g. CANopen Fieldbus: up to 127 stations with up to 320 Digital channels or up to 160 Analog channels per station.

(2) In preparation, availability on demand

(3) Feature is licensed

AC500-XC

Technical data

Digital S500-XC I/O modules

Type	DI524-XC	DC522-XC	DC523-XC	DC532-XC	DO524-XC	DO526-XC	DX522-XC	
Number of channels per module								
Digital	inputs	32	–	–	16	–	–	8
	outputs	–	–	–	–	32	8	8 relays
Configurable channels DC (configurable as inputs or outputs)		–	16	24	16	–	–	–
Additional configuration of channels as								
Fast counter		configuration of max. 2 channels per module, operating modes see table on page 171						
Occupies max. 1 DO or DC when used as counter		–	•	•	•	–	–	–
Connection via terminal unit		•	•	•	•	•	•	•
Digital inputs								
Input signal voltage		24 V DC				–	–	24 V DC
Input characteristic acc. to EN 61132-2		Type 1				–	–	Type 1
0 signal		-3...+5 V DC				–	–	-3...+5 V DC
Undefined signal state		5...15 V DC				–	–	5...15 V DC
1 signal		15...30 V DC				–	–	15...30 V DC
Input time delay (0 -> 1 or 1 -> 0)		8 ms typically, configurable from 0.1 up to 32 ms				–	–	8 ms typically, configurable from 0.1 up to 32 ms
Input current per channel								
At input voltage		24 V DC	5 mA typically		–	–	5 mA typically	
		5 V DC	> 1 mA		–	–	> 1 mA	
		15 V DC	> 5 mA		–	–	> 5 mA	
		30 V DC	< 8 mA		–	–	< 8 mA	
Digital outputs								
Transistor outputs 24 V DC		–	•	•	•	•	•	–
Readback of output		–	•	•	•	–	–	–
Relay outputs, supplied via process voltage UP, changeover contacts		–	–	–	–	–	–	•
Switching of load		24 V	•	•	•	•	•	•
		230 V	–	–	–	–	–	•
Output voltage at signal state 1		–	process voltage UP minus 0.8 V			–	process voltage UP minus 0.4 V	
Output current								
Nominal current per channel		–	500 mA at UP = 24 V			2 A at UP = 24 V	–	
Maximum (total current of all channels)		–	8 A			16 A	–	
Residual current at signal state 0		–	< 0.5 mA			–	–	
Demagnetization when switching off inductive loads		–	by internal varistors			–	–	
Switching frequency								
For inductive load		–	0.5 Hz max.			0.5 Hz max.	2 Hz	
For lamp load		–	11 Hz max. at max. 5 W			–	–	
Short-circuit / overload proofness		–	•	•	•	•	by external fuse / circuit breaker 6 A gL/gG per channel	
Overload indication (I > 0.7 A)		–	after approx. 100 ms			–	–	
Output current limiting		–	yes, with automatic reclosure			–	–	
Proofness against reverse feeding of 24 V signals		–	•	•	•	•	–	
Contact rating								
For resistive load, max.		–	–			–	3 A at 230 V AC 2 A at 24 V DC	
For inductive load, max.		–	–			–	1.5 A at 230 V AC 1.5 A at 24 V DC	
For lamp load		–	–			–	60 W at 230 V AC 10 W at 24 V DC	

AC500-XC

Technical data

Digital S500-XC I/O modules

Type	DI524-XC	DC522-XC	DC523-XC	DC532-XC	DO524-XC	DO526-XC	DX522-XC
Lifetime (switching cycles)							
Mechanical lifetime	-						300 000
Lifetime under load	-						300 000 at 24 V DC / 2 A 200 000 at 120 V AC / 2 A 100 000 at 230 V AC / 3 A
Spark suppression for inductive AC load	-						external measure depending on the switched load
Demagnetization for inductive DC load	-						external measure: free-wheeling diode connected in parallel to the load
Process voltage UP							
Nominal voltage	24 V DC						
Current consumption on UP							
Min. (module alone)	0.150 A	0.100 A	0.150 A	0.150 A	0.050 A	0.050 A	0.050 A
Max. (min. + loads)	0.150 A	0.100 A + load	0.150 A + load	0.150 A + load	0.100 A + load	0.050 A + load	0.050 A + load
Reverse polarity protection	●	●	●	●	●	●	●
Fuse for process voltage UP	10 A miniature fuse						
Connections for sensor voltage supply. Terminal 24 V and 0 V for each connection. Permitted load for each group of 4 or 8 connections: 0.5 A	-	8	4	-	-	-	-
Short-circuit and overload proof 24 V DC sensor supply voltage	-	●	●	-	-	-	-
Maximum cable length for connected process signals							
Cable	shielded	1000 m					
	unshielded	600 m					
Potential isolation							
Per module	●						
Between channels	input	-	-	-	-	-	-
	output	-	-	-	-	-	in groups of 4 ●
Voltage supply for the module	internally via extension bus interface (I/O bus)						
Fieldbus connection	via AC500-XC CPU or all communication interface modules (except DC505-FBP Fieldbus Plug module)						
Address setting	automatically (internal)						

AC500-XC

Technical data

Analog S500-XC I/O modules

Type	AX521-XC	AX522-XC	AI523-XC	AO523-XC	AI531-XC
Number of channels per module					
Individual configuration, analog	inputs 4	8	16	–	8
	outputs 4	8	–	16	–
Signal resolution for channel configuration					
-10...+10 V	12 bits + sign				15 bits + sign
0...10 V	12 bits				15 bits
0...20 mA, 4...20 mA	12 bits				15 bits
Temperature: 0.1 °C	●	●	●	–	●
Monitoring configuration per channel					
Plausibility monitoring	●	●	●	●	●
Wire break & short-circuit monitoring	●	●	●	●	●
Analog Inputs AI					
Signal configuration per AI	max. number per module and with regard to the configuration: AIs / Measuring points (depending on the use of 2/3-wire connection or differential input)				
0...10 V	4 / 4	8 / 8	16 / 16	–	8 / 8
-10...+10 V	4 / 4	8 / 8	16 / 16	–	8 / 8
0...20 mA	4 / 4	8 / 8	16 / 16	–	8 / 8
4...20 mA	4 / 4	8 / 8	16 / 16	–	8 / 8
Pt100					
-50...+400 °C (2-wire)	4 / 4	8 / 8	16 / 16	–	8 / 8
-50...+400 °C (3-wire), 2 channels	4 / 2	8 / 4	16 / 8	–	8 / 8
-50...+400 °C (4-wire)	–	–	–	–	8 / 8
-50...+70 °C (2-wire)	4 / 4	8 / 8	16 / 16	–	8 / 8
-50...+70 °C (3-wire), 2 channels	4 / 2	8 / 4	16 / 8	–	8 / 8
-50...+70 °C (4-wire)	–	–	–	–	8 / 8
Pt1000					
-50...+400 °C (2-wire)	4 / 4	8 / 8	16 / 16	–	8 / 8
-50...+400 °C (3-wire), 2 channels	4 / 2	8 / 4	16 / 8	–	8 / 8
-50...+400 °C (4-wire)	–	–	–	–	8 / 8
Ni1000					
-50...+150 °C (2-wire)	4 / 4	8 / 8	16 / 16	–	8 / 8
-50...+150 °C (3-wire), 2 channels	4 / 2	8 / 4	16 / 8	–	8 / 8
-50...+150 °C (4-wire)	–	–	–	–	8 / 8
Cu50 -200...+200 °C	–	–	–	–	8 / 8
Resistor 0...50 kΩ	–	–	–	–	8 / 8
Thermocouples of types J, K, T, N, S	–	–	–	–	●
0...10 V using differential inputs, 2 channels	4 / 2	8 / 4	16 / 8	–	8 / 8
-10...+10 V using differential inputs, 2 channels	4 / 2	8 / 4	16 / 8	–	8 / 8
Digital signals (digital input)	4 / 4	8 / 8	16 / 16	–	8 / 8
Input resistance per channel	voltage: > 100 kΩ current: approx. 330 Ω			–	voltage: > 100 kΩ current: approx. 330 Ω
Time constant of the input filter	voltage: 100 μs current: 100 μs			–	voltage: 100 μs current: 100 μs
Conversion cycle	2 ms (for 8 AI + 8 AO), 1 s for Pt100/1000, Ni1000			–	1 ms (for 8 AI + 8 AO), 1 s for Pt100/1000, Ni1000
Overvoltage protection	●	●	●	–	●

(1) Half can be used on current (the other half remains available).

AC500-XC

Technical data

Analog S500-XC I/O modules

Type		AX521-XC	AX522-XC	AI523-XC	AO523-XC	AI531-XC
Data when using the AI as digital input						
Input	time delay	8 ms typically, configurable from 0.1 up to 32 ms			–	8 ms typically, configurable from 0.1 up to 32 ms
	signal voltage	24 V DC			–	24 V DC
Signal	0	-30...+5 V			–	-30...+5 V
	1	13...30 V			–	13...30 V
Analog outputs AO						
Possible configuration per AO		Max. number of AOs per module and with regard to the configuration:				
	-10...+10 V	4	8 (1)	–	16 (1)	–
	0...20 mA	4		–	8	–
	4...20 mA	4		–	8	–
Output	resistance (burden) when used as current output	0...500 Ω		–	0...500 Ω	
	loading capability when used as voltage output	Max. ±10 mA		–	Max. ±10 mA	
Process voltage UP						
Nominal voltage		24 V DC				
Current consumption on UP						
	Min. (module alone)	0.150 A				0.130 A
	Max. (min. + loads)	0.150 A + load	0.150 A + load	–	0.150 A + load	
Reverse polarity protection		●	●	●	●	●
Max. line length of the analog lines, conductor cross section > 0.14 mm ²		100 m				
Conversion error of analog values caused by non-linearity, calibration errors ex works and the resolution in the nominal range		0.5 % typically, 1 % max.				Voltage: 0.1 % typically, current/resistor 0.3 % typically
Potential isolation						
Per module		●	●	●	●	–
Fieldbus connection		Via AC500-XC CPU or all communication interface modules (except DC505-FBP)				
Voltage supply for the module		Internally via extension bus interface (I/O bus)				–

(1) Half can be used on current (the other half remains available).

AC500-XC

Technical data

CD522-XC encoder module

The CD522-XC module offers accuracy and dynamic flexibility for a customized solution. It has two independent encoder inputs onboard and is easily configured using the Automation Builder software for 10 different operation modes and for frequencies up to 300 kHz (depending on CPU cycle time). The CD522-XC module also integrates outputs for pulses and for PWM as well as normal inputs and outputs, depending on selected encoder mode.

Type		CD522-XC
Functionality		
Digital inputs/outputs		24 V DC, dedicated inputs/outputs can be used for specific counting functions. All unused inputs/outputs can be used as input/output with standard specification.
	Input options	Catch/Touch operation, counter value stored in separate variable on external event (rising or falling) Set to preset counter register with predefined value Set to reset counter register
	End value output	Output set when predefined value is reached
	Reference point initialization (RPI) input for relative encoder initialization	•
High-speed counter/encoder		
Integrated counters	Counter characteristics	2 counters (24 V DC, 5 V DC, differential and 1 Vpp sinus input)
	Counter mode	one 32 bits or two 16 bits
	Relative position encoder	X1, X2, X3
	Absolute SSI encoder	•
	Time frequency meter	•
	Frequency input	up to 300 kHz
PWM/pulse outputs		
Output mode specification	Number of outputs	2
	Push pull output	24 V DC, 100 mA max
	Current limitation	Thermal and overcurrent
PWM mode specification	Frequency	1...100 kHz
	Value	0...100 %
Pulse mode specification	Frequency	1...15 kHz
	Pulse emission	1...65535 pulses
	Number of pulses emitted indicator	0...100 %
Frequency mode specification	Frequency output	100 kHz
	Duty Cycle	Set to 50 %
Number of channels per module		
Digital	input	2
	output	2
Configurable channels DC (configurable as inputs or outputs)		8
Additional configuration of channels as		
Fast counter		Integrated 2 counter encoders
Connection via terminal unit		•
Digital Inputs		
Input	signal voltage	24 V DC
	time delay	8 ms typically configurable from 0.1 up to 32 ms
Input current per channel		
At input voltage	24 V DC	Typically 5 mA
	5 V DC	> 1 mA
	15 V DC	> 5 mA
	30 V DC	< 8 mA

AC500-XC

Technical data

CD522-XC encoder module

Type	CD522-XC	
Digital outputs		
Output voltage at signal state 1	UP – 0.8 V	
Output current		
Nominal current per channel	0.5 A	
Maximum (total current of all channels)	8 A	
Residual current at signal state 0	< 0.5 mA	
Demagnetization when switching off inductive loads	By internal varistors	
Switching frequency		
For inductive load	Max. 0.5 Hz	
For lamp load	Max. 11 Hz with max. 5 W	
Short-circuit / Overload proofness	●	
Overload indication (I > 0.7 A)	After approx. 100 ms	
Output current limiting	●	
Proofness against reverse feeding of 24 V signals	●	
Maximum cable length for connected process signals		
Cable	shielded	1000 m
	unshielded	600 m
Potential isolation		
Per module	●	
Technical data of the high-speed inputs		
Number of channels per module	6	
Input type	24 V DC, 5 V DC / Differential / Sinus 1 Vpp	
Frequency	300 kHz	
Technical data of the fast outputs		
Number of channels	2	
Indication of the output signals	Brightness of the LED depends on the number of pulses emitted (0 % to 100 %) (pulse output mode only)	
Output current		
Rated value, per channel	100 mA at UP = 24 V	
Maximum value (all channels together, configurable outputs included)	8 A	
Leakage current with signal 0	< 0.5 mA	
Rated protection fuse on UP	10 A fast	
De-magnetization when inductive loads are switched off	with varistors integrated in the module	
Overload message (I > 0.1 x A)	Yes, after ca. 100 ms	
Output current limitation	Yes, automatic reactivation after short-circuit/overload	
Resistance to feedback against 24 V signals	Yes	
Process voltage UP		
Nominal voltage	24 V DC	
Current consumption on UP		
Min. (module alone)	0.070 A	
Max. (min. + loads)	0.070 A + load	
Reverse polarity protection	●	
Fuse for process voltage UP	10 A miniature fuse	

AC500-XC

Technical data

Analog/digital mixed I/O expansion module

For all modules: max cable length for connected process signals is 1000 m for shielded cable and 600 m for unshielded ones. For all Input modules, the signal resolution for channel configuration is: -10...+10 V: 12 bit + sign; 0...10 V, 0...20 mA, 4...20 mA: 12 bits.

Type		DA501-XC	DA502-XC
Number of Channels per Module			
Digital	inputs	16	–
	outputs	–	16
Analog	inputs	4	4
	outputs	2	2
Digital configurable channels DC (configurable as inputs or outputs)		8	8
Additional configuration of channels as			
Fast counter		Yes	
Occupies max. 1 DO or DC when used as counter		Configuration of max. 2 channels per module. Operating modes see table on page 171	
Connection via terminal unit TU 5xx		●	
Digital inputs			
Input	signal voltage	24 V DC	
	characteristic acc. to EN 61132-2	Type 1	
0 signal		-3...+5 V DC	
Undefined signal state		5...15 V DC	
1 signal		15...30 V DC	
Residual ripple, range for	0 signal	-3...+5 V DC	
	1 signal	15...30 V DC	
Input time delay (0 -> 1 or 1 -> 0)		8 ms typically, configurable from 0.1 up to 32 ms	
Digital outputs			
Transistor outputs 24 V DC, 0.5 A		●	
Readback of output		●	
Outputs, supplied via process voltage UP		●	
Switching of 24 V load		●	
Output voltage at signal state 1		Process voltage UP - 0.8 V	
Output current			
Nominal current per channel		500 mA at UP = 24 V DC	
Maximum (total current of all channels)		4 A	
Residual current at signal state 0		< 0.5 mA	
Demagnetization when switching off inductive loads		By internal varistors	
Analog inputs AI		Max. number per module and with regard to the configuration: AIs / Measuring points	
Signal configuration per AI		●	
0...10 V / -10 ... +10 V		4 / 4	
0...20 mA / 4...20 mA		4 / 4	
RTD using 2/3 wire needs 1/2 channel(s)		4 / 2	
0...10 V using differential inputs, needs 2 channels		4 / 2	
-10...+10 V using differential inputs, needs 2 channels		4 / 2	
Digital signals (digital input)		4 / 4	
Data when using the AI as digital input			
Input	time delay	8 ms typically, configurable from 0.1 up to 32 ms	
	signal voltage	24 V DC	
Outputs, single configurable as			
Possible configuration per AO		●	
-10...+10 V		●	
0...20 mA / 4...20 mA		●	
Output resistance (load) when used as current output		0...500 Ω	
Output loading capability when used as voltage output		±10 mA max.	
Potential isolation			
Per module		●	

AC500-XC

Technical data

Analog/digital mixed I/O expansion module

Type	DA501-XC	DA502-XC
Process voltage UP		
Nominal voltage	24 V DC	
Current consumption on UP		
Min. (module alone)	0.070 A	
Max. (min. + loads)	0.070 A + load	
Reverse polarity protection	●	
Fuse for process voltage UP	10 A miniature fuse	
Approvals	See detailed page 248 or www.abb.com/plc	

AC500-XC

Technical data

DC541-CM-XC interrupt I/O and fast counter module

In the operating mode counter, the channels can be configured as follows:

Input, Output, 32-bit up/down counter (uses C0...C3) as a 32-bit counter without limit, 32-bit periodic counter as a 32-bit counter with a limit, limiter for a 32-bit counter (limit channel 0), 32-bit up counter (forward counter) with the frequencies 50 kHz, 5 kHz and 2.5 kHz, pulse-width modulation (PWM) with a resolution of 10 kHz, time and frequency measurement, frequency output.

Type	DC541-CM-XC	
Number of channels per module		
Configurable channels DC (configurable as inputs or outputs)	8	
Additional configuration of channels as		
Fast counter	Yes	
Connection via CPU terminal base. Occupies one communication module slot	●	
Digital inputs		
Input signal voltage	24 V DC	
characteristic acc. to EN 61132-2	Type 1	
0 signal	-3...+5 V DC	
Undefined signal state	5...15 V DC	
1 signal	5...30 V DC	
Input time delay (0 -> 1 or 1 -> 0)	20 µs	
	Clamp to clamp - 300 µs with interrupt task	
Input current per channel		
At input voltage	24 V DC	5 mA typically
	5 V DC	> 1 mA
	15 V DC	> 5 mA
	30 V DC	< 8 mA
Digital outputs		
Transistor outputs 24 V DC, 0.5 A	●	
Readback of output	●	
Switching of 24 V load	●	
Output voltage at signal state 1	Process voltage UP minus 0.8 V	
Output current		
Nominal current per channel	500 mA at UP = 24 V	
Maximum (total current of all channels)	4 A	
Residual current at signal state 0	< 0.5 mA	
Demagnetization when switching off inductive loads	by internal varistors	
Potential isolation		
Per module	●	
Voltage supply for the module	Internally via backplane bus	

Interrupt I/O table

Configuration as	Configuration for channel no.					Max. no. of channels for this function	Remarks and notes regarding possible alternative combinations of the remaining channels (a and b)	
	Chan. 0	Chan. 1	Chan. 2	Chan. 3	Chan. 4-7			
Mode 1: Interrupt functionality								
Interrupt	Digital input	1	1	1	1	4	8	Each channel can be configured individually as interrupt input or output
	Digital output	1	1	1	1	4	8	
Mode 2: Counting functionality								
Digital I/Os	Digital input	1	1	1	1	4	8	Usual input
PWM (1)	Digital output	1	1	1	1	4	8	Usual output
	PWM, resolution 10 kHz	1	1	1	1	4	8	Outputs and pulsed signal with and adjustable on-off ratio

(1) Counter and fast counter data available on technical documentation.

AC500-XC

Technical data

AC500 Condition Monitoring CMS: FM502-CMS-XC

The FM502-CMS-XC function module offers precision and dynamic flexibility for customized solutions in condition monitoring, precise measurement or fast data logging applications. It has 16 fast, precise and synchronized analog inputs with 50k Samples/s (SPS), 24bit ADC resolution, completed with encoder inputs (incremental or absolute) with counter and additional DI and DC inputs/outputs on-board. It is easily configured using the Automation Builder software and the special libraries. Overall it has 12 different operation modes. One FM502 function module can be placed on the right side of PM592-ETH-XC CPU with a special function module terminal base TF5x1, to interface directly to the CPU. While long measurements can be flexibly configured, started and stopped, all inputs are available in the I/O Image of CPU for immediate use (measurement, protection, control, ...)

Type	FM502-CMS-XC	
Data storage		
Fast user data memory of FM502	128 MB (ca. 33 million Samples: e.g 40 s record length on 16 channels at 50k SPS or 5.8 h record length on 16 channels at 100 SPS)	
File Format delivered to PM592 flash	WAV (compact binary) per channel, all channels in one *.zip w. time stamp	
Analog inputs		
Number of channels	16 (synchronous sampled)	
Resolution	24 bit ADC, stored in DINT in WAV file (4byte per value)	
Accuracy at +25 °C	< +/- 0.1 %	
Accuracy over operating temperature and vibration	< +/- 0.5 %	
Sample rate / Bandwidth (High, 0 dB)	50k SPS / 20 kHz to 100 SPS / 40 Hz (digitally downsampled, selectable per channel)	
Indication of the input signal	One bicolor LED per channel for configuration, measurement status, error messages	
Input option:	IEPE (with Sensor supply current)	+ - 10 V
Bandwidth low (- 3 dB)	digital < 0.1 Hz	digital < 0.1 Hz or DC (selectable)
Pass band high (- 3 dB)	analog > 90 kHz, digital > 24.5 kHz	
Stop band high (> - 100 dB)	analog > 1 MHz, digital > 27.5 kHz	
Dynamic Range (SFDR)	> 100 dB	
SINAD (300 Hz/1 kHz sine, 50 k SPS) 0dB from full scale	< -90 dB	< - 95 dB
IEPE Current Source per channel	Typ. 4.2 mA (+/- 7 % over temperature)	(n.a.)
Resistance AI- to M (ground)	Typ ~ 270hm (PTC)	
Channel input impedance (AI+/AI-):		
< 1 kHz	> 1 MOhm	> 2 MOhm
5 kHz	> 100 kOhm	> 40 kOhm
10 kHz	> 60 kOhm	> 25 kOhm
20 kHz	> 40 kOhm	> 8 kOhm
Error detection	Short circuit, open wire	
Max. cable length, shielded (depending on sensor)	100 m	
Digital inputs/outputs		
	24 V DC, dedicated inputs/outputs can be used for specific counting functions.	
	All unused inputs/outputs can be used as normal input/output with standard specification.	
Channels and types	2 DI + 2 DC (configurable inputs/outputs); Type 1, LED indication	
Input options	Catch/Touch operation, counter value stored in separate variable on external event (rising or falling)	
	Set to preset counter register with predefined value	
	Set to reset counter register	
End value output	Output set when predefined value is reached	
Reference point initialization (RPI) input for relative encoder initialization	●	
Input current p. channel @ V DC		
24 V DC	Typically 5 mA	
5 V DC	> 1 mA	
15 V DC	> 5 mA	
30 V DC	< 8 mA	

AC500-XC

Technical data

AC500 Condition Monitoring CMS: FM502-CMS-XC

Type	FM502-CMS-XC	
Digital outputs		
Output voltage at signal state 1	(L+) – 0.8 V	
Output current		
Nominal current per channel	0.5 A at UP = 24 V	
Residual current at signal state 0	< 0.5 mA	
Demagnetization when switching off inductive loads	By internal varistors	
Switching frequency		
For inductive load	Max. 0.5 Hz	
For lamp load	Max. 11 Hz with max. 5 W	
Short-circuit / Overload proofness	•	
Overload indication (I > 0.7 A)	After approx. 100 ms	
Output current limiting	•	
Resistance against reverse feeding of 24 V signals	•	
Maximum cable length for connected process signals		
shielded	1000 m	
unshielded	600 m	
High-speed counter/encoder		
Integrated counters		
Counter characteristics	2 counters (24 V DC, 5 V DC, differential RS422: 5 V or 1 Vpp sinus input)	
Counter mode	one counter 32 bits or two counters 16 bits	
Relative position encoder	X1, X2, X3	
Absolute SSI encoder	•	
Time frequency meter	•	
Frequency input	up to 300 kHz	
Additional configuration of channels as		
Fast counter	Integrated 2 counter encoders	
high-speed inputs		
Number of channels, type per module	3 (A,B,Z), type 1	
Input type	24 V DC	5 V DC / Differential / Sinus 1 Vpp
Frequency	up to 300 kHz (input filter: 50,500, 5 k, 20 k Hz)	
Input frequency max. (frequency measurement only)	100 kHz (accuracy -0 %/+3 %)	
Max. cable length, shielded (depending on sensor)	300 m	100 m
Fast outputs		
SSI CLK output B	f. optical Interface (according SSI): Pin 1.3	RS-422 differential (according SSI) Pins 1.3, 1.4
Output delay (0->1 or 1->0)	Max. 0.35 µs	
Output current	≤ 10 mA	
Switching frequency (selectable)	200kHz, 500kHz and 1 MHz	
Short-circuit proof / overload proof	Yes	
Output current limitation	Yes, automatic reactivation after short-circuit/overload	
Resistance to feedback against 24V signals	Yes	
Resistance to feedback against reverse polarity	Yes	
Max. cable length, shielded (depending on sensor)	100 m	
Process voltage L+		
Nominal voltage	24 V DC	
Max. ripple	0,05	
Current consumption from L+ (FM502 and PM592, no communication module)	Max. 0.43 A + max. 0.5 A per output	
Inrush current from L+ (at power up, FM502 and PM592, no communication module)	1.2 A ² s	
Electrical isolation	Yes, (PM592 and FM502 to other I/O-Bus modules)	
Max. power dissipation within the FM502 module	6.5 W (outputs unloaded)	
5-V-encoder supply output		
Nominal voltage	5 V DC (+/- 5 %), 100 mA max.	

(1) High Temperatures:

Operation of FM502-XC version in the operating temperature range between +60 °C and +70 °C with following deratings:

No use of 24 V encoder mode

Analog inputs: maximum number of configured input channels limited to 75 % per group AI0..AI7 and AI8..AI15

AC500-XC

Technical data

AC500-XC communication modules

- Up to 4 communications modules can be used on an AC500-XC CPU
- No external power supply required.

Type	CM592-DP-XC	CM582-DP-XC	CM597-ETH-XC	CM598-CN-XC
Communication interfaces				
RJ45	-	-	● (x2) (2)	-
RS-232 / 485	-	-	-	-
Terminal blocks (1)	-	-	-	●
Sub-D socket	●	●	-	-
Protocols	PROFIBUS DP V0/V1 master	PROFIBUS DP V0/V1 slave	Ethernet (TCP/IP, UDP/IP, Modbus TCP)	CANopen master
CPU interface	8 kB Dual-port memory	8 kB Dual-port memory	8 kB Dual-port memory	8 kB Dual-port memory
Transfer Rate	9.6 kbit/s to 12 Mbit/s	9.6 kbit/s to 12 Mbit/s	10/100 Mbit/s	10 kbit/s to 1 Mbit/s
Co-processor				
Additional features	Multi master functionality Max. Number of subscribers: - 126 (V0) - 32 (V1)	-	Online Access, ICMP (Ping), DHCP, IP configuration protocol, UDP dataexchange, Modbus TCP	CAN 2.0A CAN 2.0B CANopen

Type	CM588-CN-XC	CM579-PNIO-XC	CM589-PNIO-XC	CM589-PNIO-4-XC
Communication interfaces				
RJ45	-	● (x2) (2)	● (x2) (2)	● (x2) (2)
RS-232 / 485	-	-	-	-
Terminal blocks (1)	●	-	-	-
Sub-D socket	-	-	-	-
Protocols	CANopen slave	PROFINET IO controller	PROFINET IO device	PROFINET IO 4 x device
CPU interface	8 kB Dual-port memory	8 kB Dual-port memory	8 kB Dual-port memory	8 kB Dual-port memory
Transfer Rate	10 kbit/s to 1 Mbit/s	10/100 Mbit/s	10/100 Mbit/s	10/100 Mbit/s
Co-processor				
Additional features	NMT slave, PDO, SDO server, Heartbeat, Nodeguard	RTC - Real-Time Cyclic Protocol, Class 1 RTA - Real-Time Acyclic Protocol DCP Discovery and Configuration Protocol CL-RPC - Connectionless Remote Procedure Call	RTC - Real-Time Cyclic Protocol, Class 1 RTA - Real-Time Acyclic Protocol DCP Discovery and Configuration Protocol LLDP - Link Layer Discovery Protocol	RTC - Real-Time Cyclic Protocol, Class 1 RTA - Real-Time Acyclic Protocol DCP Discovery and Configuration Protocol LLDP - Link Layer Discovery Protocol

(1) Plug-in terminal block included.

(2) 10/100 Mbit/s, full/half duplex with auto-sensing, 2-port switch integrated.

AC500-XC

Technical data

Communication interface modules

For all modules: max cable length for connected process signals is 1000 m for shielded cable and 600 m for unshielded ones. For all Input modules, the signal resolution for channel configuration is: -10...+10 V: 12 bits + sign; 0...10 V, 0...20 mA, 4...20 mA: 12 bits. Temperature: 0.1 °C.

Type	DC551-CS31-XC	CI590-CS31-HA-XC (1)	CI592-CS31-XC
Communication Interface			
Protocol	Proprietary CS31 bus protocol on RS485 interface		
ID configuration	Per rotary switches on front face from 00d to 99d		
Field bus connection on TUs	CS31 field bus, via terminal / redundant for CI590-CS31-HA-XC on TU552-CS31-XC		
Number of Channels per Module			
Digital	inputs	8	8
	outputs	–	–
Analog	inputs	–	4
	outputs	–	2
Digital configurable channels DC (configurable as inputs or outputs)	16	16	8
Additional configuration of channels as			
Fast counter	Configuration of max. 2 channels per module		
Occupies max. 1 DO or DC when used as counter	●	●	●
Connection			
Via terminal base TU5xx	●	●	●
Local I/O extension			
Max. number of extension modules	max. 7 x S500 extension modules, up to 31 stations with up to 120 DI/120 DOs or up to 32 AIs/ 32AOs per station		
Digital inputs			
Input	signal voltage	24 V DC	
	characteristic acc. to EN 61132-2	Type 1	
0 signal	-3...+5 V DC		
Undefined signal state	5...15 V DC		
1 signal	15...30 V DC		
Residual ripple, range for	0 signal	-3...+5 V DC	
	1 signal	15...30 V DC	
Input time delay (0 -> 1 or 1 -> 0)	8 ms typically, configurable from 0.1 up to 32 ms		
Digital outputs			
Transistor outputs 24 V DC, 0.5 A	●		
Readback of output	●		
Outputs, supplied via process voltage UP	●		
Switching of 24 V load	●		
Output voltage at signal state 1	Process voltage UP - 0.8 V		
Output current			
Nominal current per channel	500 mA at UP = 24 V DC		
Maximum (total current of all channels)	8 A	8 A	4 A
Residual current at signal state 0	< 0.5 mA		
Demagnetization when switching off inductive loads	By internal varistors		
Analog inputs AI			
Max. number per module and with regard to the configuration: AIs / Measuring points			
Signal configuration per AI	–	●	
0...10 V / -10...+10 V	–	4 / 4	
0...20 mA / 4...20 mA	–	4 / 4	
RTD using 2/3 wire needs 1/2 channel(s)	–	4 / 2	
0...10 V using differential inputs, needs 2 channels	–	4 / 2	
-10...+10 V using differential inputs, needs 2 channels	–	4 / 2	
Digital signals (digital input)	–	4 / 4	

(1) Dedicated to High Availability. Not compatible with S500-eCo I/O modules.

AC500-XC

Technical data

Communication interface modules

Type	DC551-CS31-XC	CI590-CS31-HA-XC (1)	CI592-CS31-XC
Data when using the AI as digital input			
Input			
time delay	-		8 ms typically, configurable from 0.1 up to 32 ms
signal voltage	-		24 V DC
Outputs, single configurable as			
Possible configuration per AO	-		●
-10...+10 V	-		●
0...20 mA / 4...20 mA	-		●
Output			
resistance (load) when used as current output	-		0...500 Ω
loading capability when used as voltage output	-		±10 mA max.
Potential isolation			
Per module	●	●	●
Between fieldbus interface against the rest of the module	●	●	●
Voltage supply for the module	By external 24 V DC voltage via terminal UP		
Process voltage UP			
Nominal voltage	24 V DC		
Current consumption on UP			
Min. (module alone)	0.100 A	0.100 A	0.070 A
Max. (min. + loads)	0.100 A + load	0.100 A + load	0.070 A + load
Reverse polarity protection	●		
Fuse for process voltage UP	10 A miniature fuse		
Approvals	See detailed page 248 or www.abb.com/plc		

(1) Dedicated to High Availability. Not compatible with S500-eCo I/O modules.

AC500-XC

Technical data

PROFIBUS-DP modules

Type	CI541-DP-XC	CI542-DP-XC	
Communication Interface			
Protocol	PROFIBUS DP (DP-V0 and DP-V1 slave)		
ID configuration	Per rotary switches on front face from 00h to FFh		
Field bus connection on terminal units	Sub-D 9 poles on TU510-XC or TU518-XC with baud rate up to 1MBaud		
Number of Channels per Module			
Digital	inputs	8	8
	outputs	8	8
Analog	inputs	4	–
	outputs	2	–
Digital configurable channels DC (configurable as inputs or outputs)	–	–	8
Additional configuration of channels as			
Fast counter (onboard I/O)	Configuration of max. 2 DI channels per module		
Occupies max 1 DO or DC when used as counter	•	•	
Connection			
Local I/O extension	•		
Max. number of extension modules	max. 10 x S500 extension modules, fast counter from digital IO modules can be also used		
Via terminal base TU5xx	•	•	
Digital inputs			
Input	signal voltage	24 V DC	
	characteristic acc. to EN 61132-2	Type 1	
0 signal	–3...+5 V DC		
Undefined signal state	5...15 V DC		
1 signal	15...30 V DC		
Residual ripple, range for	0 signal	–3...+5 V DC	
	1 signal	15...30 V DC	
Input time delay (0 -> 1 or 1 -> 0)	8 ms typically, configurable from 0.1 up to 32 ms		
Digital outputs			
Transistor outputs 24 V DC, 0.5 A	•		
Readback of output	–	• (on DC outputs)	
Outputs, supplied via process voltage UP	•		
Switching of 24 V load	•		
Output voltage at signal state 1	Process voltage UP - 0.8 V		
Output current			
Nominal current per channel	500 mA at UP = 24 V DC		
Maximum (total current of all channels)	8 A		
Residual current at signal state 0	< 0.5 mA		
Demagnetization when switching off inductive loads	By internal varistors		
Analog Inputs AI			
	Max. number per module and with regard to the configuration: AIs / Measuring points		
Signal configuration per AI	4	–	
0...10 V / -10...+10 V	4 / 4	–	
0...20 mA / 4...20 mA	4 / 4	–	
RTD using 2/3 wire needs 1/2 channel(s)	4 / 2	–	
0...10 V using differential inputs, needs 2 channels	4 / 2	–	
-10...+10 V using differential inputs, needs 2 channels	4 / 2	–	
Digital signals (digital input)	4 / 4	–	
Data when using the AI as digital input			
Input	time delay	8 ms typically, configurable from 0.1 up to 32 ms	–
	signal voltage	24 V DC	–

AC500-XC

Technical data

PROFIBUS-DP modules

Type	CI541-DP-XC	CI542-DP-XC
Outputs, single configurable as		
Possible configuration per AO	●	-
-10...+10V	●	-
0...20 mA / 4...20 mA	●	-
Output	resistance (load) when used as current output	0...500 Ω
	loading capability when used as voltage output	±10 mA max.
Potential isolation		
Per module	●	●
Between fieldbus interface against the rest of the module	●	●
Between the channels	input	-
	output	-
Voltage supply for the module	By external 24 V DC voltage via terminal UP	
Process voltage UP		
Nominal voltage	24 V DC	
Current consumption on UP		
	Min. (module alone)	0.260 A
	Max. (min. + loads)	0.260 A + load
Reverse polarity protection	●	
Fuse for process voltage UP	10 A miniature fuse	
Approvals	See detailed page 248 or www.abb.com/plc	

AC500-XC

Technical data

CANopen modules

Type	CI581-CN-XC	CI582-CN-XC
Communication interface		
Protocol	CANopen slave, DS401 profile selectable using rotary switches	
ID configuration	Per rotary switches on front face for CANopen ID node from 00h to 7Fh and 80h to FFh for CANopen DS401 profile	
Field bus connection on terminal units	Terminal blocks on TU518-XC	
Number of channels per module		
Digital	inputs	8
	outputs	8
Analog	inputs	–
	outputs	–
Digital configurable channels DC (configurable as inputs or outputs)	–	8
Additional configuration of channels as		
Fast counter (onboard I/O)	Configuration of max. 2 DI channels per module	
Occupies max. 1 DO or DC when used as counter	●	●
Connection		
Local I/O extension	●	
Max. number of extension modules	max. 10 x S500-XC extension modules	
Via terminal unit TU5xx	●	●
Digital inputs		
Input	signal voltage	24 V DC
	characteristic acc. to EN 61132-2	Type 1
0 signal		-3...+5 V DC
Undefined signal state		5...15 V DC
1 signal		15...30 V DC
Residual ripple, range for	0 signal	-3...+5 V DC
	1 signal	15...30 V DC
Input time delay (0 -> 1 or 1 -> 0)	8 ms typically, configurable from 0.1 up to 32 ms	
Digital outputs		
Transistor outputs 24 V DC, 0.5 A	●	
Readback of output	–	● (on DC outputs)
Outputs, supplied via process voltage UP	●	
Switching of 24 V load	●	
Output voltage at signal state 1	Process voltage UP - 0.8 V	
Output current		
Nominal current per channel	500 mA at UP = 24 V DC	
Maximum (total current of all channels)	8 A	
Residual current at signal state 0	< 0.5 mA	
Demagnetization when switching off inductive loads	By internal varistors	
Analog Inputs AI		
Max. number per module and with regard to the configuration: AIs / Measuring points		
Signal configuration per AI	4	–
0...10 V / -10...+10 V	4 / 4	–
0...20 mA / 4...20 mA	4 / 4	–
RTD using 2/3 wire needs 1/2 channel(s)	4 / 2	–
0...10 V using differential inputs, needs 2 channels	4 / 2	–
-10...+10 V using differential inputs, needs 2 channels	4 / 2	–
Digital signals (digital input)	4 / 4	–
Data when using the AI as digital input		
Input	time delay	8 ms typically, configurable from 0.1 up to 32 ms
	signal voltage	24 V DC

AC500-XC

Technical data

CANopen modules

Type	CI581-CN-XC	CI582-CN-XC
Outputs, single configurable as		
Possible configuration per AO	●	-
-10...+10 V	●	-
0...20 mA / 4...20 mA	●	-
Output	resistance (load) when used as current output	0...500 Ω
	loading capability when used as voltage output	±10 mA max.
Potential isolation		
Per module	●	●
Between fieldbus interface against the rest of the module	●	●
Between the channels	input	-
	output	-
Voltage supply for the module	By external 24 V DC voltage via terminal UP	
Process voltage UP		
Nominal voltage	24 V DC	
Current consumption on UP		
	Min. (module alone)	0.260 A
	Max. (min. + loads)	0.260 A + load
Reverse polarity protection	●	
Fuse for process voltage UP	10 A miniature fuse	
Approvals	See detailed page 248 or www.abb.com/plc	

AC500-XC

Technical data

PROFINET IO RT device modules

Type	CI501-PNIO-XC	CI502-PNIO-XC	CI504-PNIO-XC	CI506-PNIO-XC
Communication interface				
Ethernet Interface				
Main protocol	PROFINET IO RT device			
ID Device configuration	By rotary switch on the front side, from 00h to FFh			
Ethernet connection on terminal units	2 x RJ45 with switch functionality for simple daisy chain on TU508-ETH-XC or TU520-ETH-XC			
Gateway Interface				
Gateway to	-	-	3 x RS232/RS422/ RS485 ASCII serial interfaces	CAN / CANopen Master + 2 x RS232/RS422/ RS485 ASCII serial interfaces
Fieldbus Protocol used				
CAN physical interface	-	-	-	CAN 2A/2B Master - CANopen Master (1)
Baudrate	-	-	-	Baudrate up to 1 MBit/s, Support for up to 126 CANopen Slaves
Serial interface				
Protocol used	-	-	3 x RS232 / RS422 or RS485	2 x RS232 / RS422 or RS485
Baudrate	-	-	Configurable from 300 bit/s to 115200 bit/s	
Fieldbus or serial connection on TUs	-	-	3 x pluggable terminal blocks with spring on TU520-ETH	
Number of channels per module				
Digital	inputs	8	8	-
	outputs	8	8	-
Analog	inputs	4	-	-
	outputs	2	-	-
Digital configurable channels DC (configurable as inputs or outputs)		-	8	-
Additional configuration of channels as				
Connection via terminal unit TU5xx		-	-	●
Fast counter (onboard I/O)		Configuration of max. 2 DI channels per module		-
Occupies max. 1 DO or DC when used as counter		●	-	-
Connection				
Local I/O extension		●	-	●
Max. number of extension modules		max. 10 x S500-XC extension modules. Fast counter from digital IO modules can be also used.		Valid for CI501-XC, 502-XC, 504-XC and 506-XC. All modules can have extension up to 10 modules
Digital inputs				
Input	signal voltage	24 V DC		-
	characteristic acc. to EN 61132-2	Type 1		-
0 signal		-3...+5 V DC		-
Undefined signal state		5...15 V DC		-
1 signal		15...30 V DC		-
Residual ripple, range for	0 signal	-3...+5 V DC		-
	1 signal	15...30 V DC		-
Input time delay (0 -> 1 or 1 -> 0)		8 ms typically, configurable from 0.1 up to 32 ms		-
Digital outputs				
Transistor outputs 24 V DC, 0.5 A		●	-	-
Readback of output		-	● (on DC outputs)	-
Outputs, supplied via process voltage UP		●	-	-
Switching of 24 V load		●	-	-
Output voltage at signal state 1		Process voltage UP - 0.8 V		-

(1) Not simultaneously.

AC500-XC

Technical data

PROFINET IO RT device modules

Type	CI501-PNIO-XC	CI502-PNIO-XC	CI504-PNIO-XC	CI506-PNIO-XC
Output current				
Nominal current per channel	500 mA at UP = 24 V DC		-	-
Maximum (total current of all channels)	8 A		-	-
Residual current at signal state 0	< 0.5 mA		-	-
Demagnetization when switching off inductive loads	By internal varistors		-	-
Analog inputs AI				
	Max. number per module and with regard to the configuration: AIs / Measuring points			
Signal configuration per AI	4	-	-	-
0...10 V / -10... +10 V	4 / 4	-	-	-
0...20 mA / 4...20 mA	4 / 4	-	-	-
RTD using 2/3 wire needs 1/2 channel(s)	4 / 2	-	-	-
0...10 V using differential inputs, needs 2 channels	4 / 2	-	-	-
-10...+10 V using differential inputs, needs 2 channels	4 / 2	-	-	-
Digital signals (digital input)	4 / 4	-	-	-
Data when using the AI as digital input				
Input	time delay	8 ms typically, configurable from 0.1 up to 32 ms	-	-
	signal voltage	24 V DC	-	-
Outputs, single configurable as				
Possible configuration per AO	●	-	-	-
-10...+10 V	●	-	-	-
0...20 mA / 4...20 mA	●	-	-	-
Output	resistance (load) when used as current output	0...500 Ω	-	-
	loading capability when used as voltage output	±10 mA max.	-	-
Potential isolation				
Per module	●	●	●	●
Between Ethernet interface against the rest of the module	●	●	●	●
Voltage supply for the module	By external 24 V DC voltage via terminal UP			
Process voltage UP				
Nominal voltage	24 V DC			
Current consumption on UP				
	min. (module alone)	0.260 A	0.150 A	
	max. (min. + loads)	0.260 A + load	0.150 A + load	
Reverse polarity protection	●			
Fuse for process voltage UP	10 A miniature fuse			
Approvals	See detailed page 248 or www.abb.com/plc			

(1) Not simultaneously.

AC500-XC

Technical data

Modbus TCP modules

Type	CI521-MODTCP-XC	CI522-MODTCP-XC	
Communication interface			
Ethernet Interface			
Main protocol	Modbus TCP		
ID Device configuration	By rotary switch on the front side, from 00h to FFh		
Ethernet connection on terminal units	2 x RJ45 with switch functionality for simple daisy chain on TU508-ETH-XC or TU520-ETH-XC		
Number of channels per module			
Digital	inputs	8	8
	outputs	8	8
Analog	inputs	4	–
	outputs	2	–
Digital configurable channels DC (configurable as inputs or outputs)		–	8
Additional configuration of channels as			
Connection via terminal unit TU5xx	–	–	
Fast counter (onboard I/O)	Configuration of max. 2 DI channels per module		
Occupies max. 1 DO or DC when used as counter	●		
Connection			
Local I/O extension	●		
Max. number of extension modules	max. 10 x S500-XC extension modules. Fast counter from digital IO modules can be also used.		
Digital inputs			
Input	signal voltage	24 V DC	
	characteristic acc. to EN 61132-2	Type 1	
0 signal	–3...+5 V DC		
Undefined signal state	5...15 V DC		
1 signal	15...30 V DC		
Residual ripple, range for	0 signal	–3...+5 V DC	
	1 signal	15...30 V DC	
Input time delay (0 -> 1 or 1 -> 0)	8 ms typically, configurable from 0.1 up to 32 ms		
Digital outputs			
Transistor outputs 24 V DC, 0.5 A	●		
Readback of output	–	● (on DC outputs)	
Outputs, supplied via process voltage UP	●		
Switching of 24 V load	●		
Output voltage at signal state 1	Process voltage UP - 0.8 V		
Output current			
Nominal current per channel	500 mA at UP = 24 V DC		
Maximum (total current of all channels)	8 A		
Residual current at signal state 0	< 0.5 mA		
Demagnetization when switching off inductive loads	By internal varistors		
Analog inputs AI			
Max. number per module and with regard to the configuration: AIs / Measuring points			
Signal configuration per AI	4	–	
0...10 V / -10... +10 V	4 / 4	–	
0...20 mA / 4...20 mA	4 / 4	–	
RTD using 2/3 wire needs 1/2 channel(s)	4 / 2	–	
0...10 V using differential inputs, needs 2 channels	4 / 2	–	
-10...+10 V using differential inputs, needs 2 channels	4 / 2	–	
Digital signals (digital input)	4 / 4	–	

(1) Not simultaneously.

AC500-XC

Technical data

Modbus TCP modules

Type	CI521-MODTCP-XC	CI522-MODTCP-XC	
Data when using the AI as digital input			
Input	time delay	8 ms typically, configurable from 0.1 up to 32 ms	-
	signal voltage	24 V DC	-
Outputs, single configurable as			
Possible configuration per AO		•	-
-10...+10 V		•	-
0...20 mA / 4...20 mA		•	-
Output	resistance (load) when used as current output	0...500 Ω	-
	loading capability when used as voltage output	±10 mA max.	-
Potential isolation			
Per module		•	•
Between Ethernet interface against the rest of the module		•	•
Voltage supply for the module		By external 24 V DC voltage via terminal UP	
Process voltage UP			
Nominal voltage		24 V DC	
Current consumption on UP			
min. (module alone)		0.260 A	
max. (min. + loads)		0.260 A + load	
Reverse polarity protection		•	
Fuse for process voltage UP		10 A miniature fuse	
Approvals		See detailed page 248 or www.abb.com/plc	

(1) Not simultaneously.

AC500-XC

Technical data

CS31 functionality

	AC500-XC CPU with integrated CS31 interface	S500 I/O with communication interface DC551-CS31-XC CI590-CS31-HA-XC CI592-CS31-XC
Master	Yes, at COM1	-
Slave	No	Yes / Redundant for CI590-CS31-HA-XC
Protocols supported	ABB CS31 protocol	
Diagnosis		
Error indication	On LCD display of the CPU	Via module LEDs
Online diagnosis	Yes	
Error code	Errors are recorded in the diagnosis system of the CPU	
Associated function blocks	Yes	
Physical layer		
Connection	RS485 / 2 x RS485 for CI590-CS31-HA-XC for redundancy	Screw-type or spring-type terminals
Baud rate	187.5 kbit/s	
Distance	AC500-XC: up to 500 m; up to 2000 m using a repeater	
Max. number of modules on fieldbus	31 modules max. Please note: The CS31 bus interface occupies one or two module addresses (if counters are configured onboard or if the module is a mixed digital analog module). Depending on the configuration, or if the module contains also mixed digital analog I/O, connected extension modules can occupy further module addresses.	
Configuration		
Station address configuration	Using configuration tool (included in Automation Builder software suite)	Using rotary switches (99 max.)

Digital I/O modules, "Fast Counter" operating modes. Not applicable for DC541-XC (1)

Operating mode, configured in the user program of the AC500-XC	Occupied inputs DI or DC	Occupied outputs DO or DC	Maximum counting frequency kHz
0 No counter	0	0	-
1 One count-up counter with "end value reached" indication	1	1	50
2 One count-up counter with "enable" input and "end value reached" indication	2	1	50
3 Two up/down counters	2	0	50
4 Two up/down counters with 1 counting input inverted	2	0	50
5 One up/down counter with "dynamic set" input	2	0	50
6 One up/down counter with "dynamic set" input	2	0	50
7 One up/down counter with directional discriminator For synchro transmitters using two counting pulses with an offset of 90° (track A and B)	2	0	50
8 -	0	0	-
9 One up/down counter with directional discriminator and double evaluation For synchro transmitters using two counting pulses with an offset of 90° towards each other (track A and B)	2	0	30
10 One up/down counter with directional discriminator and fourfold evaluation For synchro transmitters using two counting pulses with an offset of 90° towards each other (track A and B)	2	0	15

(1) See technical documentation for details.

AC500-XC

System data

Environmental Conditions

Process and supply voltages

24 V DC	Voltage	24 V (-15 %, +20 %)
	Protection against reverse polarity	yes
Allowed interruptions of power supply	DC supply	Interruption < 10 ms, time between 2 interruptions > 1 s, PS2
	AC supply	Interruption < 0.5 periods, time between 2 interruptions > 1 s

Important: Exceeding the maximum process and supply voltages could lead to unrecoverable damage of the system. The system could be destroyed. For the supply of the modules, power supply units in accordance with PELV or SELV specifications must be used. The creepage distances and clearances meet the requirements of the overvoltage category II, pollution degree 2.

Assembly position

Horizontal	•
Vertical	• (1)

(1) not in salt mist environment

Temperature

Operating	-40 °C ... +70 °C	
	-40 °C ... -30 °C	Proper start-up of system; technical data not guaranteed
	-40 °C ... 0 °C	Due to the LCD technology, the display might not be readable
	-40 °C...+40 °C	vertical mounting of modules possible, output load limited to 50 % per group
	+60 °C ...+70 °C	with the following deratings:
		System is limited to max. 2 Communication Modules per Terminal Base
	Applications certified for cULus up to 60 °C	
	Digital inputs: maximum number of simultaneously switched on input channels limited to 75 % per group (e.g. 8 channels => 6 channels)	
	Digital outputs: output current maximum value (all channels together) limited to 75 % per group (e.g. 8 A => 6 A)	
	Analog outputs only if configured as voltage output: maximum total output current per group is limited to 75 % (e.g. 40 mA => 30 mA)	
	Analog outputs only if configured as current output: maximum number of simultaneously used output channels limited to 75 % per group (e.g. 4 channels => 3 channels)	
Storage / Transport	-40 °C ... +85 °C	

Humidity

Operating / Storage	100 % r. H. with condensation
---------------------	-------------------------------

Air pressure

Operating	-1000 m 4000 m (1080 hPa ... 620 hPa)
-----------	--

Storage	>2000 m (<795 hPa): max. operating temperature must be reduced by 10K per 1000 m (e.g. 70 °C to 60°C)
---------	---

Immunity to corrosive gases

Operating	<p>Yes, in accordance with:</p> <p>ANSI/ISA-71.04: Containment group A, G3 - Harsh / GX - Severe</p> <p>IEC 60068-2-60: Method 4</p> <p>IEC 60721-3-3: Class 3C2 / 3C3</p> <p>Gases and concentrations: Hydrogen sulfide (H₂S): (100 ± 5) ppb Nitrogen dioxide (NO₂): (1250 ± 20) ppb Chlorine (Cl₂): (100 ± 5) ppb Sulfur dioxide (SO₂): (300 ± 20) ppb</p>
-----------	--

Immunity to salt mist

Operating	<p>Yes, horizontal mounting only, in accordance with IEC 60068-2-52 severity level: 1</p> <p>NOTICE!</p> <p>Risk of corrosion!</p> <p>Unused connectors and slots may corrode, if using XC devices in salt mist environments.</p> <p>Protect unused connectors and slots with TA535 protective caps for XC devices.</p>
-----------	---

AC500-XC

System data

Environmental Conditions

Electromagnetic Compatibility

Radiated emission (radio disturbances)	Yes, in accordance with CISPR 16-2-3
Conducted emission (radio disturbances)	Yes, in accordance with CISPR 16-2-1, CISPR 16-1-2
Electrostatic discharge (ESD)	Yes, in accordance with IEC 61000-4-2, zone B, criterion B Electrostatic voltage in case of air discharge: 8 kV Electrostatic voltage in case of contact discharge: 6 kV
Fast transient interference voltages (burst)	Yes, in accordance with IEC 61000-4-4, zone B, criterion B Supply voltage units (DC): 4 kV Digital inputs/outputs (24 V DC): 2 kV Analog inputs/outputs: 2 kV Communication lines shielded: 2 kV I/O supply (DC-out): 2 kV
High energy transient interference voltages (surge)	Yes, in accordance with IEC 61000-4-5, zone B, criterion B Supply voltage units (DC): 1 kV CM* / 0.5 kV DM* Supply voltage units (AC): 2 kV CM* / 1 kV DM* Digital inputs/outputs (24 V DC): 1 kV CM* / 0.5 kV DM* Digital inputs/outputs (120...240 V AC): 2 kV CM* / 1 kV DM* Analog inputs/outputs: 1 kV CM* / 0.5 kV DM* Communication lines shielded: 1 kV CM* I/O supply (DC-out): 0,5 kV CM* / 0.5 kV DM* * CM = Common Mode, * DM = Differential Mode
Influence of radiated disturbances	Yes, in accordance with IEC 61000-4-3, zone B, criterion A Test field strength: 10 V/m
Influence of line-conducted interferences	Yes, in accordance with IEC 61000-4-6, zone B, criterion A Test voltage: 10 V
Influence of power frequency magnetic fields	Yes, in accordance with IEC 61000-4-8, zone B, criterion A 30 A/m 50 Hz 30 A/m 60 Hz

WARNING!

Risk of malfunctions and damages to persons!

Unused slots for communication modules are not protected against contact discharge. Dust and dirt may cause contact problems and malfunctions.

Unused slots for communication modules must be covered with dummy communication modules ("TA524 - Dummy communication module").

I/O-bus connectors must not be touched during operation.

In order to prevent malfunctions, it is recommended that the operating personnel discharge themselves prior to touching communication connectors or perform other suitable measures to reduce effects of electrostatic discharges.

Environmental Tests

Storage	IEC 60068-2-1 Test Ab: cold withstand test -40 °C / 16 h IEC 60068-2-2 Test Bb: dry heat withstand test +85 °C / 16 h
Humidity	IEC 60068-2-30 Test Db: cyclic (12 h / 12 h) damp-heat test 55 °C, 93 % r. H. / 25 °C, 95 % r. H., 6 cycles IEC 60068-2-78, Stationary Vibration Test: 40 °C, 93 % r. H., 240 h
Shock resistance	IEC 61131-2 / IEC 60068-2-6: 5 Hz ... 500 Hz, 2 g (with SD memory card inserted) IEC 60068-2-64: 5 Hz ... 500 Hz, 4 g rms IEC 60068-2-27: all 3 axes 15 g, 11 ms, half-sinusoidal

Mechanical Data

Wiring method	Spring terminals
Degree of protection	IP 20
Assembly on DIN rail	DIN rail type In accordance with IEC 60715 35 mm, depth 7.5 mm or 15 mm
Assembly with screws	Screw diameter 4 mm
	Fastening torque 1.2 Nm

AC500-S

Functional Safety PLC

177	Key features
178	Ordering data AC500-S
179	Ordering data AC500-S-XC
180–182	Technical data
183–186	System data

SM560-S

ABB

WR
DIAG
RUN
ERR
ERR

SYS
BATT
I/O-Bus

run

ETH
FBP
COM
COM

PWR

RUN

ERR

90
2 3 4 5 6 7 8 9
1 0 F E D C B A ADDR x10H
2 3 4 5 6 7 8 9
1 0 F E D C B A ADDR x01H

WARNING
Use of incorrect battery may cause fire or explosion.

RUN
DIAG
VAL
CFG
ESC
↑
OK
↓

MC 502

UP 24VDC 10W

AC500-S

Key features

- 
- The image shows a yellow ABB AC500-S safety PLC unit. It is a vertical, rack-mounted device with a front panel featuring several status LEDs (PWR, OK, RUN, I-ERR, E-ERR) and two rotary switches labeled 'ADDR 1' and 'ADDR 2'. The top of the unit has a red label with 'ABB' and 'EM580-S'.
- - Easy integration: Simple expansion of ABB PLC with safety functions. One common engineering and diagnostic system for safety and standard CPUs. eXtreme Conditions (-XC) version is available.
 - - Easy implementation of flexible configuration concept (one safety program for various machine types). Safety CPU can be configured to work even if standard CPU is in STOP mode.
 - - Automation Builder productivity suite providing integrated support of ST, Ladder (LD) and Function Block Diagram (FBD) programming with a common look and feel. Trigonometric functions are supported for easy implementation of complex calculation tasks.
 - - PROFINET/PROFIsafe interface for decentralized safety I/Os, safe position and speed monitoring as well as triggering of safety drive functions.

AC500-S

Ordering data

Safety CPU

Description	User program memory		Type	Order code	Price	Weight (1 pce) kg
	MB					
Safety CPU module	1		SM560-S	1SAP280000R0001		0.100
Safety CPU module with F-Device functionality for 1 PROFI-safe network	1.3		SM560-S-FD-1	1SAP286000R0001		0.100
Safety CPU module with F-Device functionality for 4 PROFI-safe networks	1.3		SM560-S-FD-4	1SAP286100R0001		0.100

S500 Safety I/O

Description	Input signal		Output signal SIL3	Type	Order code	Price	Weight (1 pce) kg
	SIL2	SIL3					
Safety digital input module	16	8	-	DI581-S	1SAP284000R0001		0.130
Safety digital input / output module	8	4	8	DX581-S	1SAP284100R0001		0.130
Safety analog input module	4	2	-	AI581-S	1SAP282000R0001		0.130

S500 Safety terminal unit

Description	Type	Order code	Price	Weight (1 pce) kg
Spring terminal unit for safety I/O modules	TU582-S	1SAP281200R0001		0.200

Software

AC500-S Safety PLC programming license needs to be purchased as an additional feature of Automation Builder. For details, see ordering data of Automation Builder.



SM560-S
SM560-S-FD-1
SM560-S-FD-4



DI581-S
DX581-S
AI581-S



TU582-S

Accessories for AC500-S

For	Description	Type	Order code	Price	Weight (1 pce) kg
AC500-S Safety PLC training case	SM560-S, DI581-S, DX581-S, AI581-S, TU582-S with PM573-ETH and PNIO	TA514-SAFETY	1SAP182900R0001		10



AC500-S training case

AC500-S-XC

Ordering data

Safety XC CPU

Description	User program memory		Type	Order code	Price	Weight (1 pce) kg
	MB					
Safety CPU module	1		SM560-S-XC	1SAP380000R0001		0.100
Safety CPU module with F-Device functionality for 1 PROFI-safe network	1.3		SM560-S-FD-1-XC	1SAP386000R0001		0.100
Safety CPU module with F-Device functionality for 4 PROFI-safe networks	1.3		SM560-S-FD-4-XC	1SAP386100R0001		0.100

S500-XC Safety I/O

Description	Input signal		Output signal SIL3	Type	Order code	Price	Weight (1 pce) kg
	SIL2	SIL3					
Safety digital input module	16	8	-	DI581-S-XC	1SAP484000R0001		0.130
Safety digital input / output module	8	4	8	DX581-S-XC	1SAP484100R0001		0.130
Safety analog input module	4	2	-	AI581-S-XC	1SAP482000R0001		0.130

S500-XC Safety terminal unit

Description	Type	Order code	Price	Weight (1 pce) kg
Spring terminal unit for safety I/O modules	TU582-S-XC	1SAP481200R0001		0.200



SM560-S-XC
SM560-S-FD-1-XC
SM560-S-FD-4-XC



DI581-S-XC
DX581-S-XC
AI581-S-XC



TU582-S-XC

AC500-S and AC500-S-XC

Technical data

Safety CPUs

Type		SM560-S / SM560-S-XC	SM560-S-FD-1 / SM560-S-FD-4 / SM560-S-FD-1-XC / SM560-S-FD-4-XC
Performance level		PL e (ISO 13849-1)	
Safety	integrity level	SIL3 (IEC 61508:2010, IEC 62061, IEC 61511)	
	protocol	PROFIsafe V2 F-Host via PROFINET	PROFIsafe V2 F-Host and F-Device (for 1 or 4 PROFIsafe networks, respectively) via PROFINET
Program memory flash EPROM and RAM		1 MB	1.3 MB
Integrated data memory		1 MB thereof 120 KB saved	1.0 MB thereof 120 kB saved
Cycle time for 1 instruction			
Binary		0.05 µs	
Word		0.06 µs	
Floating point		0.5 µs	
Max. number of centralized inputs/outputs			
Max. nb. of safety extension modules on I/O bus		10	
Digital	inputs	160 (SIL2) / 80 (SIL3)	
	outputs	80 (SIL3)	
Analog	inputs	40 (SIL2) / 20 (SIL3)	
Max. number of decentralized inputs/outputs		On PROFINET: up to 128 stations with up to 10 safety extension modules	
Program execution			
Cyclical		•	
User program protection by password		•	
Interfaces			
Ethernet		Via AC500 CPU or PROFINET coupler	
COM		Via AC500 CPU	
Programming		Via AC500 CPU	
Approvals		CE, cUL, UL, C-Tick and other on request	

AC500-S and AC500-S-XC

Technical data

S500 and S500-XC Safety I/O

Type	DI581-S / DI581-S-XC	DX581-S / DX581-S-XC	AI581-S / AI581-S-XC
Performance Level	PL e (ISO 13849-1)		
Safety Integrity Level	SIL3 (IEC 61508:2010, IEC 62061, IEC 61511)		
Safety protocol	PROFIsafe V2 via PROFINET		
Digital inputs			
Number of channels per module	16 (SIL2) / 8 (SIL3)	8 (SIL2) / 4 (SIL3)	-
Input signal voltage	24 V DC	24 V DC	-
Frequency range	65 Hz	65 Hz	-
Input characteristic acc. to EN61131-2	Type 1	Type 1	-
0 signal	-3...+5 V DC	-3...+5 V DC	-
Undefined signal state	5...15 V DC	5...15 V DC	-
1 signal	15...30 V DC	15...30 V DC	-
Input time delay (0 -> 1 or 1 -> 0)	Input filter configurable from 1, 2, 5...500 ms	Input filter configurable from 1, 2, 5...500 ms	-
Test pulse outputs	8	4	-
Input current per channel			
At input voltage	24 V DC / 7 mA typically	24 V DC / 7 mA typically	-
	5 V DC / < 1 mA	5 V DC / < 1 mA	-
	15 V DC / > 4 mA	15 V DC / > 4 mA	-
	30 V DC / < 8 mA	30 V DC / < 8 mA	-
Digital outputs			
Number of channels per module	-	8 (SIL3)	-
Transistor outputs 24 V DC, 0.5 A	-	●	-
Transistor outputs 24 V DC, 2 A	-	● (1)	-
Switching of 24 V load	-	●	-
Safety relay outputs	-	● (2)	-
Output current			
Nominal current per channel	-	500 mA at UP = 24 V	-
Maximum (total current of all channels)	-	4 A / 500 mA / channel	-
Residual current at signal state 0	-	< 0.5 mA	-
Demagnetization when switching off inductive loads	-	By internal suppressor diodes	-
Switching frequency			
Short-circuit / overload proofness	-	●	-
For inductive load	-	On request	-
For lamp load	-	On request	-
Proofness against reverse feeding of 24 V signals	-	●	-

(1) Transistor outputs 24 V DC, 2 A. For details, please see application notes in chapter 8.

(2) Safety relay outputs using external safety relay, e.g. ABB BSR23. For details, please see application notes in chapter 8.

AC500-S and AC500-S-XC

Technical data

S500 and S500-XC Safety I/O

Type	DI581-S / DI581-S-XC	DX581-S / DX581-S-XC	AI581-S / AI581-S-XC
Analog inputs			
Number of channels per module	-	-	4 (SIL2) / 2 (SIL3)
Input resistance per channel	-	-	125 Ohm
Time constant of the input filter	-	-	10 ms
Conversion cycle	-	-	0.33 ms
Overvoltage protection	-	-	-
Signal resolution for channel configuration			
0...20 mA, 4...20 mA	-	-	14 bits
Process voltage UP			
Nominal voltage	24 V DC		
Maximum ripple	5 %		
Reverse polarity protection	●		
Fuse for process voltage UP	10 A miniature fuse		
Connections for sensor voltage supply Terminal 24 V and 0 V	●		
Conversion error of analog values caused by non-linearity, calibration errors ex and the resolution in the nominal range	-	-	±1.5 %
Maximum cable length for connected process signals			
Shielded cable	1000 m	1000 m	-
Unshielded cable	600 m	600 m	-
Max. line length of the analog lines, conductor cross section > 0.14 mm ²	-	-	100 m
Potential isolation			
Per module	●		
Fieldbus connection	Via AC500 CPU or PROFINET communication module		
Voltage supply for the module	Internally via extension bus interface (I/O bus)		
Approvals	CE, cUL, UL, C-Tick and other on request		

AC500-S

System data

Operating and ambient conditions

Voltages according to EN 61131-2

24 V DC	Process and supply voltage	24 V (-15 %, +20 %)
	Protection against reverse polarity	Yes
Allowed interruptions of power supply acc. to EN 61131-2	DC supply	Interruption < 10 ms, time between 2 interruptions > 1 s

Important: Exceeding the maximum process and supply voltages could lead to unrecoverable damage of the system. The system could be destroyed.

Temperature

Operating	0 °C ... +60 °C	horizontal mounting of modules
	0 °C ... +40 °C	vertical mounting of modules and output load reduced to 50 % per group
Storage / Transport	-40 °C ... +70 °C	

Humidity

Operating / Storage	Max. 95 %, without condensation
---------------------	---------------------------------

Air pressure

Operating	> 800 hPa / < 2000 m
Storage	> 660 hPa / < 3500 m

Creepage distances and clearances

Insulation Test Voltages, Routine Test, according to EN 61131-2	AC voltage during 2 seconds
24 V circuits (supply, 24 V inputs/outputs), if they are electrically isolated against other circuitry	350 V

The creepage distances and clearances meet the requirements of the overvoltage category II, pollution degree 2.

AC500-S

System data

Power supply units

For the supply of the modules, power supply units according to PELV specifications must be used.

Electromagnetic Compatibility

Immunity		
Against electrostatic discharge (ESD)		
Electrostatic voltage in case of	air discharge	±8 kV
	contact discharge	±6 kV
ESD with communication connectors		
In order to prevent operating malfunctions, it is recommended that the operating personnel discharge themselves prior to touching communication connectors or perform other suitable measures to reduce effects of electrostatic discharges.		
ESD with connectors of Terminal Bases		
The connectors between the Terminal Bases and CPUs or Communication Modules must not be touched during operation. The same is valid for the I/O-Bus with all modules involved.		
Against the influence of radiated (CW radiated)		
Test field strength		10 V/m
Against transient interference voltages (burst)		
Supply voltage units	DC	2 kV
Digital inputs/outputs	24 V DC	2 kV
Analog inputs		1 kV
Against the influence of line-conducted interferences (CW conducted)		
Test voltage		10 V zone B
High energy surges		
Power supply	DC	1 kV CM (1) / 0.5 kV DM (2)
DC I/O supply, add. DC-supply-out		0.5 kV CM (2) / 0.5 kV DM (2)
I/O analog, I/O DC unshielded		1 kV CM (2) / 0.5 kV DM (2)
Radiation (radio disturbance)		
In accordance with EN 55011, group 1, class A		

(1) High requirement for shipping classes is achieved with additional specific measures (see specific documentation).

(2) CM = Common Mode; DM = Differential Mode.

Mechanical Data

Wiring method / terminals	
Mounting	Horizontal (DIN rail mounting)
Degree of protection	IP20
Housing	In accordance with UL 94
Vibration resistance acc. to EN 61131-2	all three axes (DIN rail mounting) 5...11.9 Hz, continuous 3.5 mm 11.9...150 Hz, continuous 1 g
Shock resistance	All three axes 15 g, 11 ms, half-sinusoidal
Mounting of the modules	
DIN rail according to DIN EN 50022	35 mm, depth 7.5 mm or 15 mm
Mounting with screws	Screws with a diameter of 4 mm
Fastening torque	1.2 Nm

AC500-S-XC

System data

Operating and ambient conditions

Voltages according to EN 61131-2

24 V DC	Process and supply voltage	24 V (-15 %, +20 %)
	Protection against reverse polarity	Yes
Allowed interruptions of power supply acc. to EN 61131-2	DC supply	Interruption < 10 ms, time between 2 interruptions > 1 s

Important: Exceeding the maximum process and supply voltages could lead to unrecoverable damage of the system. The system could be destroyed.

Temperature

Operating	-40 °C ... +70 °C	horizontal mounting of modules
	-40 °C ... +40 °C	vertical mounting of modules and output load reduced to 50 % per group
Storage / Transport	-40 °C ... +85 °C	

Humidity

Operating / Storage	Max. 100 %, with condensation
---------------------	-------------------------------

Air pressure

Operating	620...1080 hPa / (-1000...4000 m) > 2000 m (< 795 hPa): max. operating temperature must be reduced by 10 °C.
Storage	> 620 hPa / < 4000 m

Creepage distances and clearances

Insulation Test Voltages, Routine Test, according to EN 61131-2	AC voltage during 2 seconds
24 V circuits (supply, 24 V inputs/outputs), if they are electrically isolated against other circuitry	350 V

The creepage distances and clearances meet the requirements of the overvoltage category II, pollution degree 2.

AC500-S-XC

System data

Power supply units

For the supply of the modules, power supply units according to PELV specifications must be used.

Electromagnetic Compatibility

Immunity		
Against electrostatic discharge (ESD)		
Electrostatic voltage in case of	air discharge	±8 kV
	contact discharge	±6 kV
ESD with communication connectors		
In order to prevent operating malfunctions, it is recommended that the operating personnel discharge themselves prior to touching communication connectors or perform other suitable measures to reduce effects of electrostatic discharges.		
ESD with connectors of Terminal Bases		
The connectors between the Terminal Bases and CPUs or Communication Modules must not be touched during operation. The same is valid for the I/O-Bus with all modules involved.		
Against the influence of radiated (CW radiated)		
Test field strength		10 V/m
Against transient interference voltages (burst)		
Supply voltage units	DC	2 kV
Digital inputs/outputs	24 V DC	2 kV
Analog inputs		1 kV
Against the influence of line-conducted interferences (CW conducted)		
Test voltage		10 V zone B
High energy surges		
Power supply	DC	1 kV CM (1) / 0.5 kV DM (2)
DC I/O supply, add. DC-supply-out		0.5 kV CM (2) / 0.5 kV DM (2)
I/O analog, I/O DC unshielded		1 kV CM (2) / 0.5 kV DM (2)
Radiation (radio disturbance)		
In accordance with EN 55011, group 1, class A		

(1) High requirement for shipping classes is achieved with additional specific measures (see specific documentation).

(2) CM = Common Mode; DM = Differential Mode.

Mechanical Data

Wiring method / terminals	
Mounting	Horizontal (DIN rail mounting)
Degree of protection	IP20
Housing	In accordance with UL 94
Vibration resistance acc. to EN 61131-2	all three axes (DIN rail mounting) 5...11.9 Hz, continuous 3.5 mm 11.9...150 Hz, continuous 1 g
Shock resistance	All three axes 15 g, 11 ms, half-sinusoidal
Mounting of the modules	
DIN rail according to DIN EN 50022	35 mm, depth 7.5 mm or 15 mm
Mounting with screws	Screws with a diameter of 4 mm
Fastening torque	1.2 Nm

CP600-eCo, CP600 and CP600-Pro

Control panels

191	Key features
192–194	Ordering data
195–199	Technical data

← → 15:38:22
10 Jul 2018

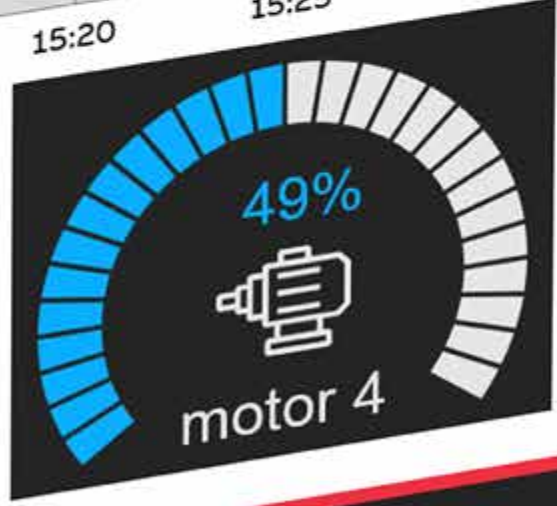
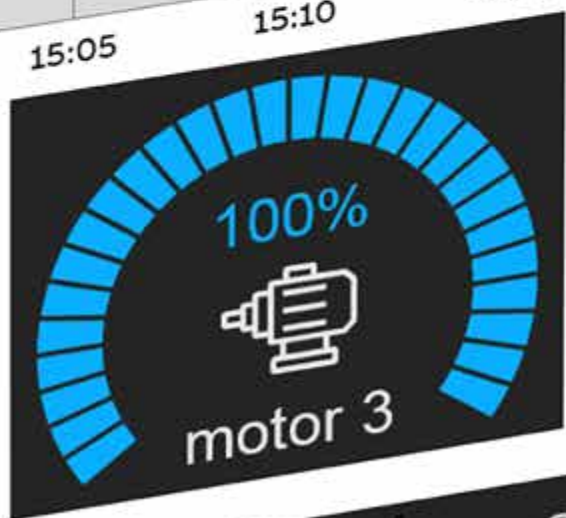
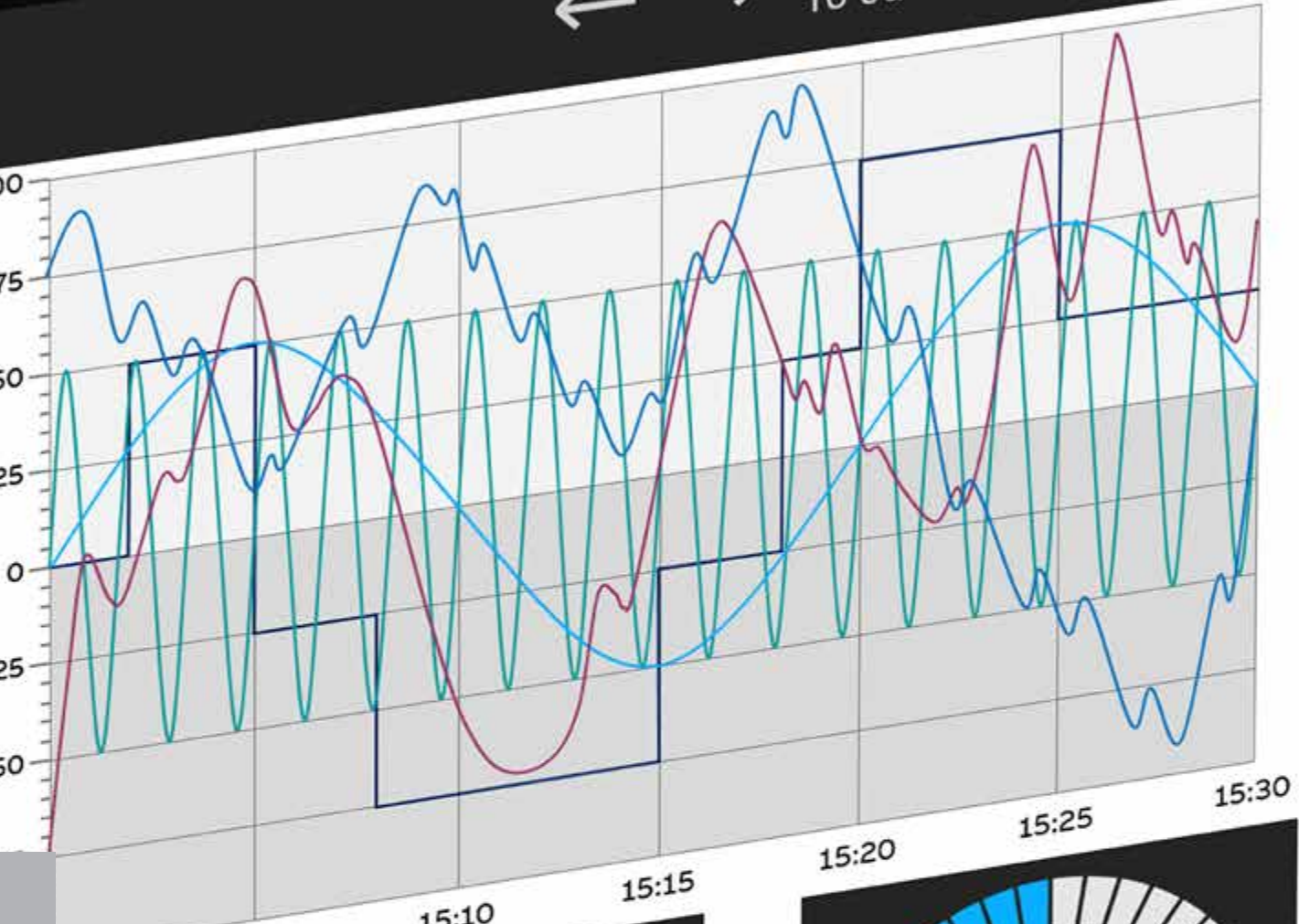

HVAC

Chiller

Alarm

e 2

CP600-eCo, CP600 and CP600-Pro

Key features

Various options for tailor made HMI solutions:

- PB610 Panel Builder 600 HMI applications
- Visualization of AC500 web servers
- Mobile remote access to HMI applications
- PB610-R PC runtime for Windows platforms
- Drivers for integration into automation systems
- OPC UA client and server



- CP600 2nd gen. brilliant colored display
- Aluminium enclosure
- Operating temp.: 0...60 °C
- Three different screen sizes
- CP600 available in parallel

- CP600-Pro multi-touch
- Brilliant real glass screen
- Aluminium enclosure
- Fast ETH 10/100/1000
- Operating temp.: -20...+60 °C
- Five different screen sizes from 5" to 21.5"

- CP600-eCo slim design for easy installation even in compact spaces
- Robust plastic enclosure
- Three different screen sizes

CP600-eCo, CP600 and CP600-Pro

Ordering data

CP600-eCo control panels

Display size	Resolution pixels	Description	Type	Order code	Price	Weight (1 pce) kg
4.3"	480 x 272	for PB610 applications	CP604	1SAP504100R0001		0.400
7.0"	800 x 480	for PB610 applications	CP607	1SAP507100R0001		0.600
10.1"	1024 x 600	for PB610 applications or visualization of AC500 V3 web server	CP610	1SAP510100R0001		1.000
4.3"	480 x 272	black, for PB610 applications	CP604-B	1SAP504100R2001		0.400
7.0"	800 x 480	black, for PB610 applications	CP607-B	1SAP507100R2001		0.600
10.1"	1024 x 600	black, for PB610 applications or visualization of AC500 V3 web server	CP610-B	1SAP510100R2001		1.000

Visualization of AC500 V3 web server is supported by products with revision index C1 or higher.



CP600 2nd generation control panels

Display size	Resolution pixels	Description	Type	Order code	Price	Weight (1 pce) kg
7"	800 x 480	for PB610 applications or visualization of AC500 V3 web server	CP6407	1SAP540710R0001		1.000
10.4"	800 x 600	for PB610 applications or visualization of AC500 V3 web server	CP6410	1SAP541010R0001		2.000
15"	1024 x 768	for PB610 applications or visualization of AC500 V3 web server	CP6415	1SAP541510R0001		3.300



CP600-eCo, CP600 and CP600-Pro

Ordering data

CP600 control panels

Display size	Resolution pixels	Description	Type	Order code	Price	Weight (1 pce) kg
4.3"	480 x 272	for PB610 Panel Builder 600 applications	CP620	1SAP520100R0001		0.950
4.3"	480 x 272	for visualization of AC500 V2 web server	CP620-WEB	1SAP520200R0001		0.950
5.7"	320 x 240	for PB610 Panel Builder 600 applications	CP630	1SAP530100R0001		1.150
5.7"	320 x 240	for visualization of AC500 V2 web server	CP630-WEB	1SAP530200R0001		1.150
7.0"	800 x 480	for PB610 Panel Builder 600 applications	CP635	1SAP535100R0001		1.100
7.0"	800 x 480	black, for PB610 Panel Builder 600 applications	CP635-B	1SAP535100R2001		1.100
7.0"	800 x 480	for visualization of AC500 V2 web server	CP635-WEB	1SAP535200R0001		1.100
10.4"	800 x 600	for PB610 Panel Builder 600 applications	CP651	1SAP551100R0001		2.100
10.4"	800 x 600	for visualization of AC500 V2 web server	CP651-WEB	1SAP551200R0001		2.100
12.1"	800 x 600	for PB610 Panel Builder 600 applications	CP661	1SAP561100R0001		2.800
12.1"	800 x 600	for visualization of AC500 V2 web server	CP661-WEB	1SAP561200R0001		2.800
13.3"	1280 x 800	for PB610 Panel Builder 600 applications	CP665	1SAP565100R0001		2.600
13.3"	1280 x 800	for visualization of AC500 V2 web server	CP665-WEB	1SAP565200R0001		2.600
15"	1024 x 768	for PB610 Panel Builder 600 applications	CP676	1SAP576100R0001		3.600
15"	1024 x 768	for visualization of AC500 V2 web server	CP676-WEB	1SAP576200R0001		3.600



CP600-Pro control panels

Display size	Resolution pixels	Description	Type	Order code	Price	Weight (1 pce) kg
5.0"	800 x 480	for PB610 applications or visualization of AC500 V3 web server	CP6605	1SAP560510R0001		1.000
7.0"	800 x 480	for PB610 applications or visualization of AC500 V3 web server	CP6607	1SAP560710R0001		1.300
10.1"	1280 x 800	for PB610 applications or visualization of AC500 V3 web server	CP6610	1SAP561010R0001		1.700
15.6"	1366 x 768	for PB610 applications or visualization of AC500 V3 web server	CP6615	1SAP561510R0001		4.100
21.5"	1920 x 1080	for PB610 applications or visualization of AC500 V3 web server	CP6621	1SAP562110R0001		6.100



CP600-eCo, CP600 and CP600-Pro

Ordering data

CP600 control panels, sanitary design

Display size	Resolution pixels	Description	Type	Order code	Price	Weight (1 pce) kg
7.0"	800 x 480	stainless steel frame, front: IP69, blue for PB610 Panel Builder 600 applications	CP635-FB	1SAP535110R6001		2.500
7.0"	800 x 480	stainless steel frame, front: IP69, white for PB610 Panel Builder 600 applications	CP635-FW	1SAP535110R1001		2.500



CP635-FB



CP635-FW

Communication cables (connection control panel <--> PLC)

Description	Type	Order code	Price	Weight (1 pce) kg
Communication cable RS232: CP600-eCo, CP600 2nd gen., CP600, CP600-Pro <--> AC500	TK681	1SAP500981R0001		0.130
Communication cable RS485: CP600-eCo, CP600 2nd gen., CP600, CP600-Pro <--> AC500-eCo	TK682	1SAP500982R0001		0.130

Programming software licenses

Description	Type	Order code	Price	Weight (1 pce) kg
PB610 Panel Builder 600, engineering tool license for CP600-eCo, CP600 2nd gen., CP600, CP600-Pro control panels and PB610-R PC-runtime, for stand-alone installation via Automation Builder installer. PB610 is included in Automation Builder Standard.	PB610	1SAP500900R0101		0.005
PB610-R Panel Builder 600 runtime license for running a PB610 application on one Windows 32-/64-Bit platform. Installation via Automation Builder installer.	PB610-R	1SAP500901R0101		0.005

CP600 platform selection guide for tailor made HMI applications

CP600-eCo	for PB610 HMI applications; CP610: Or visualization of AC500 V3 web server (*)
CP600 2nd gen.	for PB610 HMI applications or visualization of AC500 V3 web server
CP600	for PB610 HMI applications
CP600-WEB	for visualization of AC500 V2 web server
CP600-Pro	for PB610 HMI applications or visualization of AC500 V3 web server

(*) Supported by products with revision index C1 or higher

CP600-eCo series

Technical data

Type	CP604 CP604-B	CP607 CP607-B	CP610 CP610-B
Application	control panels for PB610 Panel Builder 600 applications		visualization of AC500 V3 web server (*)
Display			
Exact display size diameter	4.3" widescreen	7" widescreen	10.1" widescreen
Resolution	480 x 272 pixels	800 x 480 pixels	1024 x 600 pixels
Display type, colors	TFT-LCD, 65536 colors		
Touch screen material	glass covered by plastic film		
Touch screen type	single-touch, analog resistive, 4 wires		
Backlight type, life	LED, 20 000 h typ at 25 °C		
Brightness	150 cd/m ²	200 cd/m ²	
System resources			
Processor type	ARM Cortex-A8; 300 MHz	ARM Cortex-A8; 300 MHz	ARM Cortex-A8; 1 GHz
Operating system, version	Linux RT		
Application memory	for HMI projects of 30 MB in total plus 30 MB for fonts		
Interfaces			
Ethernet ports, number, type	1 - 10/100 Mbit		
USB Host ports number, type	1 - ver. 2.0		
Serial ports number, type	1 - RS-232/-485/-422 software configurable		
Card slot number, type	none		
Power supply			
Power supply voltage nominal, tolerance	24 V DC, 18...32 V DC		
Current consumption at nominal voltage	0.25 A	0.3 A	0.4 A
Backup power type	Supercapacitor, 72 h at 25 °C		
Enclosure			
Degree of protection front, rear	IP66, IP20		
Front frame material	Plastic		
Reverse side material	Plastic		
Weight	0.4 kg	0.6 kg	1.0 kg
Faceplate dimensions (L x H)	147 mm x 107 mm	187 mm x 147 mm	282 mm x 197 mm
Faceplate depth	5 mm		6 mm
Enclosure depth	29 mm		
Cutout dimensions (L x H)	136 mm x 96 mm	176 mm x 136 mm	271 mm x 186 mm
Environmental conditions			
Operating temperature range	0...50 °C		
Operating humidity range	5...85 % relative humidity, non-condensing		
Storage temperature range	-20...+70 °C		
Storage humidity range	5...85 % relative humidity, non-condensing		
Approvals	See detailed page 248 or www.abb.com/plc		

(*) Supported by products with revision index C1 or higher

CP600 series, 2nd generation

Technical data

Type	CP6407	CP6410	CP6415
Application	control panels for PB610 Panel Builder 600 applications or visualization of AC500 V3 web server		
Display			
Exact display size diameter	7" widescreen	10.4"	15"
Resolution	800 x 480 pixels	800 x 600 pixels	1024 x 768 pixels
Display type, colors	TFT-LCD, 65536 colors		
Touch screen material	glass covered by plastic film		
Touch screen type	single-touch, analog resistive, 4 wires		
Backlight type, life	LED, 40 000 h typ at 25 °C		
Brightness	400 cd/m ²		
System resources			
Processor type	ARM Cortex-A8; 1 GHz		
Operating system, version	Linux RT		
Application memory	150 MB		
Interfaces			
Ethernet ports, number, type	2 - 10/100 Mbit (with integrated bridge function)		
USB Host ports number, type	2 - ver. 2.0		
Serial ports number, type	1 - RS-232/-485/-422 software configurable		
Card slot number, type	1 - SD card slot		
Power supply			
Power supply voltage nominal, tolerance	24 V DC, 18...32 V DC		
Current consumption at nominal voltage	0.35 A	0.4 A	0.7 A
Backup power type, capacity	Rechargeable Lithium battery, not user-replaceable		
Enclosure			
Degree of protection front, rear	IP66, IP20		
Front frame material	aluminium		
Reverse side material	aluminium		
Weight	1 kg	2 kg	3.3 kg
Faceplate dimensions (L x H)	187 mm x 147 mm	287 mm x 232 mm	392 mm x 307 mm
Faceplate depth	4 mm		
Enclosure depth	40 mm	40 mm	45 mm
Cutout dimensions (L x H)	176 mm x 136 mm	276 mm x 221 mm	381 mm x 296 mm
Environmental conditions			
Operating temperature range	0...60 °C		
Operating humidity range	5... 85 % relative humidity, non-condensing		
Storage temperature range	-20...+70 °C		
Storage humidity range	5... 85 % relative humidity, non-condensing		
Approvals	See detailed page 248 or www.abb.com/plc		

CP600 series

Technical data

Type	CP620	CP630	CP635, CP635-B	CP651	CP661	CP665	CP676
Application	control panels for PB610 Panel Builder 600 applications						
Type	CP620-WEB	CP630-WEB	CP635-WEB	CP651-WEB	CP661-WEB	CP665-WEB	CP676-WEB
Application	control panels for visualization of AC500 V2 web server						
Display							
Exact display size diameter	4.3" widescreen	5.7"	7" widescreen	10.4"	12.1"	13.3" widescreen	15"
Resolution	480 x 272 pixels	320 x 240 pixels	800 x 480 pixels	800 x 600 pixels	800 x 600 pixels	1280 x 800 pixels	1024 x 768 pixels
Display type, colors	TFT-LCD, 65536 colors						
Touch screen material	glass covered by plastic film						
Touch screen type	single-touch, analog resistive, 4 wires						
Backlight type, life	LED, 40 000 h typ at 25 °C						
Brightness	150 cd/m ²	200 cd/m ²	300 cd/m ²				
System resources							
Processor type	ARM Cortex A8: 600 MHz			ARM Cortex A8: 1 GHz			
Operating system, version	Microsoft Windows CE 6.0 Core						
Application memory	for HMI projects of up to 30 MB in total			for HMI projects of up to 60 MB in total			
Interfaces							
Ethernet ports, number, type	2 - 10/100 Mbit (with integrated switch function)						
USB Host ports number, type	1 - ver. 2.0	2 - 1 ver. 2.0, 1 ver. 2.0 and ver. 1.1					
Serial ports number, type	1 - RS-232/-485/-422 software configurable						
Card slot number, type	1 - SD card slot						
Power supply							
Power supply voltage nominal, tolerance	24 V DC, 18...32 V DC						
Current consumption at nominal voltage	0.4 A	0.7 A	0.7 A	1.0 A	1.05 A	1.15 A	1.4 A
Backup power type	Rechargeable Lithium battery, not user-replaceable						
Enclosure							
Degree of protection front, rear	IP66, IP20						
Front frame material	Zamak			Aluminium			
Reverse side material	Zamak	Aluminium					
Weight	0.95 kg	1.15 kg	1.1 kg	2.1 kg	2.8 kg	2.6 kg	3.8 kg
Faceplate dimensions (L x H)	147 x 107 mm	187 x 147 mm		287 x 232 mm	336 x 267 mm		392 x 307 mm
Faceplate depth	4 mm						
Enclosure depth	52 mm	47 mm		56 mm		60 mm	
Cutout dimensions (L x H)	136 x 96 mm	176 x 136 mm		276 x 221 mm	326 x 256 mm		381 x 296 mm
Environmental conditions							
Operating temperature range	0...50 °C						
Operating humidity range	5...85 % relative humidity, non-condensing						
Storage temperature range	-20...+70 °C						
Storage humidity range	5...85 % relative humidity, non-condensing						
Approvals	See detailed page 248 or www.abb.com/plc						

CP600-Pro series

Technical data

Type	CP6605	CP6607	CP6610	CP6615	CP6621
Application	control panels for PB610 Panel Builder 600 applications or visualization of AC500 V3 web server				
Display					
Exact display size diameter	5" widescreen	7" widescreen	10.1" widescreen	15.6" widescreen	21.5" widescreen
Resolution	800 x 480 pixels	800 x 480 pixels	1280 x 800 pixels	1366 x 768 pixels	1920 x 1080 pixels
Display type, colors	TFT-LCD, 65536 colors		TFT-LCD, 16 Mio colors		
Touch screen material	true glass, black passepartou				
Touch screen type	multi-touch, 2-points gestures, PCAP, projected capacitive touchscreen				
Backlight type, life time	LED, 40 000 h typ at 25 °C				
Brightness	300 cd/m ²	500 cd/m ²	500 cd/m ²	300 cd/m ²	300 cd/m ²
System resources					
Processor type	ARM Cortex-A8; 1 GHz	ARM Cortex-A9 dual core; 800 MHz	ARM Cortex-A9 dual core; 800 MHz	ARM Cortex-A9 quad core; 800 MHz	ARM Cortex-A9 quad core; 800 MHz
Operating system, version	Linux RT				
Application memory	for HMI projects of up to 240 MB in total				
Interfaces					
Ethernet ports, number, type	2 - 10/100 Mbit (with integrated bridge function)	2 - 10/100 Mbit (with integrated bridge function) 1 - 10/100/1000 Mbit			
USB Host ports, number, type	1 - ver. 2.0	2 - ver. 2.0			
Serial ports number, type	1 - RS-232/-485/-422 software configurable				
Card slot number, type	1 - SD card slot				
Power supply					
Power supply voltage nominal, tolerance	24 V DC, 18...32 V DC				
Current consumption at nominal voltage	1.0 A	0.7 A	1.0 A	1.2 A	1.7 A
Backup power type, capacity	Rechargeable Lithium battery, not user-replaceable				
Enclosure					
Degree of protection front, rear	IP66, IP20				
Front frame material	aluminium, black				
Reverse side material	aluminium				
Weight	1.0 KG	1.3 kg	1.7 kg	4.1 kg	6.1 kg
Faceplate dimensions (L x H)	147 mm x 107 mm	187 mm x 147 mm	282 mm x 197 mm	422 mm x 267 mm	552 mm x 347 mm
Faceplate depth	8.5 mm	8.5 mm	8.5 mm	8.5 mm	8.5 mm
Enclosure depth	52 mm	47 mm	52 mm	56 mm	56 mm
Cutout dimensions (L x H)	136 mm x 96 mm	176 mm x 136 mm	271 mm x 186 mm	411 mm x 256 mm	541 mm x 336 mm
Environmental conditions					
Operating temperature range	-20...+60 °C				
Operating humidity range	5...85 % relative humidity, non-condensing				
Storage temperature range	-20...+70 °C				
Storage humidity range	5...85 % relative humidity, non-condensing				
Approvals	See detailed page 248 or www.abb.com/plc				

CP600 sanitary design

Technical data

Type	CP635-FB	CP635-FW
Application	control panels, sanitary design for PB610 Panel Builder 600 applications	
Display		
Exact display size diameter	7" widescreen	
Resolution	800 x 480 pixels	
Display front color	blue, RAL 5010	white, RAL 9003
Display type, colors	TFT type, 65536 colors	
Touch screen material	glass covered by protection foil	
Touch screen type	single-touch, PCAP, projected capacitive touchscreen	
Backlight type, life time	LED, 40 000 h typ at 25 °C	
Brightness	400 cd/m ²	
System resources		
Processor type	ARM Cortex A8: 1 GHz	
Operating system, version	Microsoft Windows CE 6.0 Core	
Memory	for HMI projects of up to 60 MB in total	
Interfaces		
Ethernet ports, number, type	2 - 10/100 Mbit (with integrated switch function)	
USB Host ports, number, type	2 - 1 ver. 2.0, 1 ver. 2.0 and ver. 1.1	
Serial ports number, type	1 - RS-232/-485/-422 software configurable	
Card slot number, type	1 - SD card slot	
Power supply		
Power supply voltage nominal, tolerance	24 V DC, 18...32 V DC	
Current consumption at nominal voltage	0.9 A	
Backup power type, capacity	Rechargeable Lithium battery, not user-replaceable	
Enclosure		
Degree of protection front, rear	IP69, IP20	
Front frame material	stainless steel	
Reverse side material	aluminium	
Weight	2.5 kg	
Faceplate dimensions (L x H)	215 mm x 175 mm	
Faceplate depth	9.5 mm	
Enclosure depth	46 mm	
Cutout dimensions (L x H)	176 mm x 136 mm	
Environmental conditions		
Operating temperature range	-20...+60 °C	
Operating humidity range	5...85 % relative humidity, non-condensing	
Storage temperature range	-40...+85 °C	
Storage humidity range	5...85 % relative humidity, non-condensing	
Approvals	See detailed page 248 or www.abb.com/plc	

Application descriptions and additional information

202–203	AC500 as IoT gateway
204–205	IEC 61850 protocol for substation and switchboard automation with AC500
206–207	Future-proof building automation with AC500
208–209	Building automation with AC500, KNX and BACnet
210–211	AC500 HA offers hot standby redundancy
212–213	Hot Swap of S500 I/O modules for increased availability
214–215	S500 I/O modules run with various controllers
216–217	AC500 PLC integration in ABB Ability™ System 800xA
218–219	Condition Monitoring with AC500 PLC
220–221	Machine controllers based on AC500 PLC
222	Real-time Ethernet functionality
224–225	Safer, greener and more productive with AC500-S safety PLC
226–227	Embedding safety I/Os in ABB robots enhances man-machine collaboration
228–229	Safe communication between safety CPUs
230–231	Triggering safety actions using standard HMI
232–234	PLC training and support
235	Cyber Security
236–237	PLC training and support
238–241	AC31 adapter for retrofitting existing AC31 applications, AC31 adapter for spare parts
242	Services
243	Life cycle management
244–246	Automation Builder product life cycle plan
247	Generic composition of type designation
248–254	Certifications

Application descriptions

AC500 as IoT gateway

Cost efficient and expandable solution

- Scalable & platform-independent cloud connectivity
- Adaptable functionality through interchangeable modules
- Smart data handling on edge-level for cost-efficient cloud-solutions

Connection of single controller

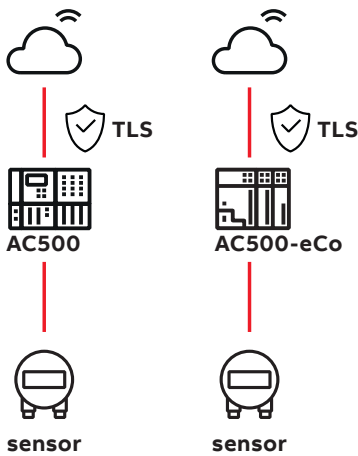

Security level: optimized for remote units

AC500 works as edge-gateway and is directly connected to the cloud. Security is established through TLS encryption.

Benefits:

- No additional gateway required
- Low latency

Application:

Small systems with non-critical data transfer.

Connection of secured network

Security level: advanced

Connection of the whole AC500 network to the cloud using a separate gateway. Enhanced security is provided through additional firewall and/or VPN.

Benefits:

- Advanced level of security
- Easy integration of many edge devices

Application:

Large systems with many devices which need higher protection.

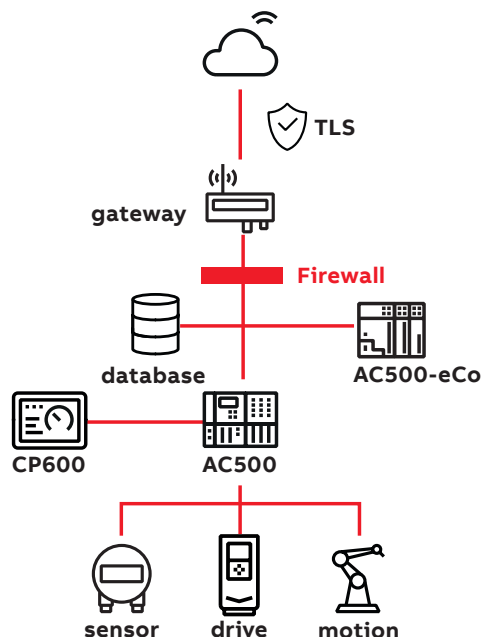

IoT gateway

Application

Small applications with simple I/Os and direct data transfer (e.g. energy monitoring of radio towers)

Benefits

- Cost-efficient
- Resource-friendly
- Low implementation effort



TELECOMMUNICATION

IoT Controller Advanced

Application

Applications with functional safety requirements which need additional functionality (e.g. functional safety control for cranes)

Benefits

- Ensured safety for machines and staff



CRANES

IoT data center

Application

Critical assets that need permanent protection & monitoring (e.g. vibration monitoring for pumps)

Benefits

- Permanent asset protection
- Increased resilience to internet outages
- Cost efficient monitoring



WATER

IoT controller

Application

Demanding applications with a larger system architecture and complex data handling (e.g. remote data logging for drives/winch control)

Benefits

- Easy cloud connection of whole system
- Active control of transferred data
- Advanced control functionalities



MARINE

Application descriptions

IEC 61850 protocol for substation and switchboard automation with AC500

AC500 as freely programmable 61850 controller, gateway or IED

AC500 is used as Intelligent Electronic Device (IED), RTU or controller

IEC 61850 is a standard protocol for state-of-the-art, future-proof substation automation, which replaces hard wiring of signals by communication over the network. The AC500 V3 can be programmed to act as an Intelligent Electronic Device (IED), RTU or used in control applications such as e.g. load shedding.

Interoperability between devices made easy

Generic Object-Oriented Substation Event (GOOSE) messages are used for the interoperability of devices with minimal delay, e.g. for fast tripping or interlocking or monitoring applications. With the IEC 61850 library and the comfortable communication the AC500 PLC can be used for the publishing of and subscribing to GOOSE messages.

The AC500 PLC can also act as server for connection-oriented communication according to the Manufacturing Messaging Specification (MMS).

Easy engineering

Automation Builder integrates the IED configuration which supports the import and export of files in the Substation Configuration Language (SCL) and code creation for the AC500. SCL allows transferring configuration information between various IEDs. The functionality of the devices can be programmed in IEC 61131 languages with Automation Builder.

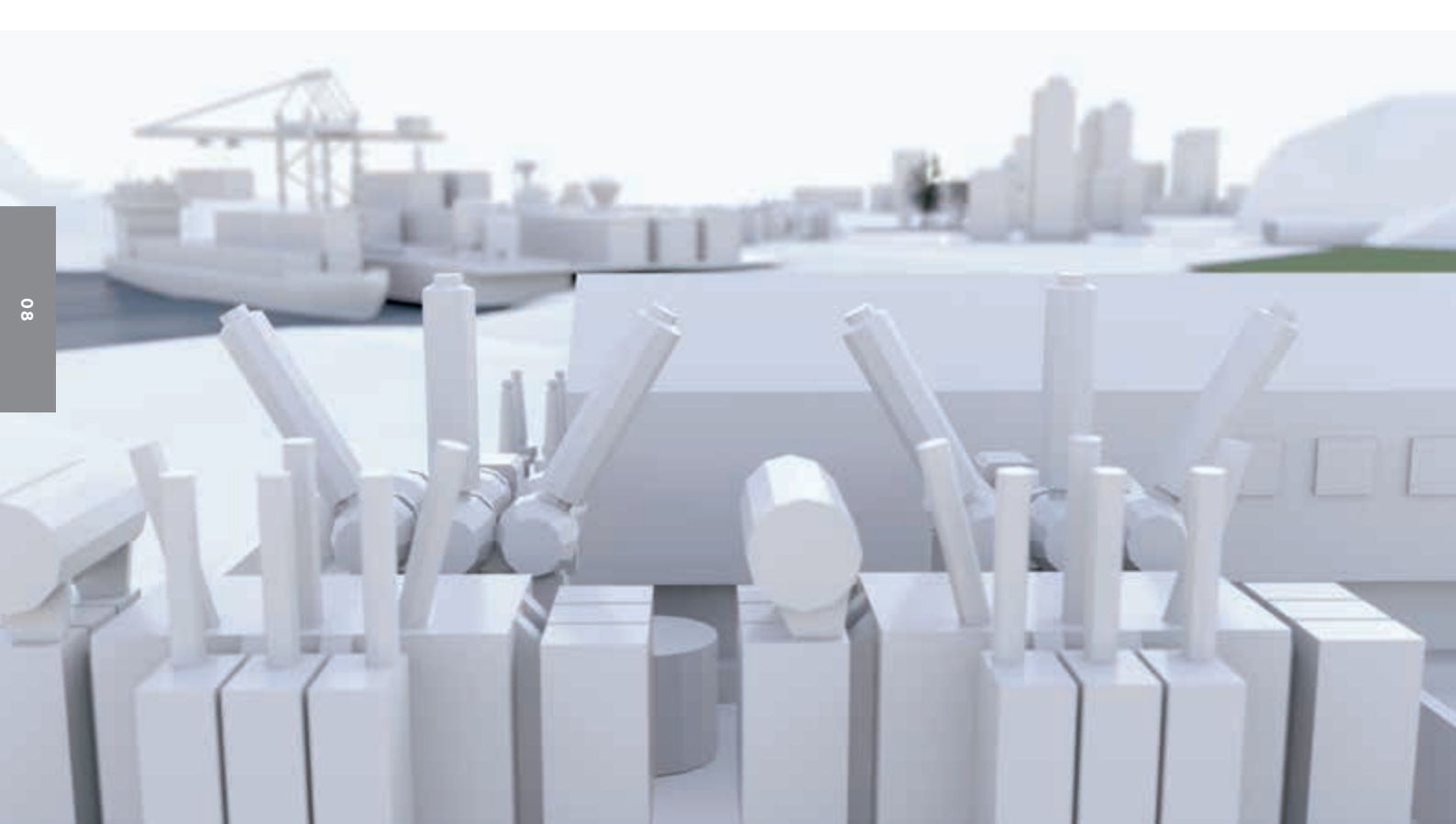

Integral solution

All-in-one platform 60870-104, 61850, Modbus, combined with OPC DA, OPC UA, MQTT. Automation Builder Engineering with the comfortable IED configuration tool and flexible IEC programming functionality and C-code integration.

AC500 can interface to a large amount of IEDs and map their data in control and monitoring direction to a 60870-5-104 , OPC UA or MQTT communication as required or act on other IEDS e.g with advanced logic in load shedding control applications. AC500 can also help to modernize and digitalize an existing and aging infrastructure.

Application example 61850

AC500 can precisely control and monitor all levels (switchboard, substation and process) and connect them via 61850 or interface to the outside world (RTU).

Please watch our videos on our ABB PLC YouTube channel:



www.youtube.com/user/abbplc

AC500 application levels

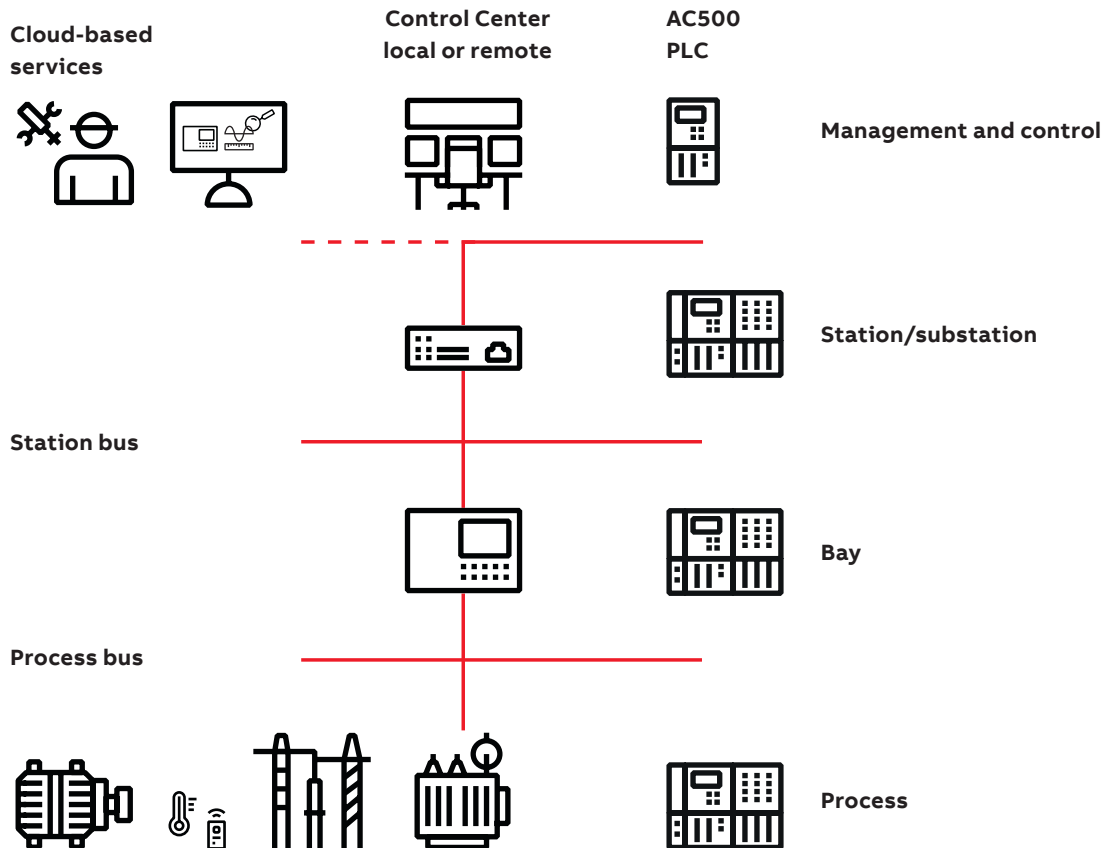

Application descriptions

Future-proof building automation with AC500

AC500 as freely programmable building automation controller

Sustainability and profitability

Connecting the Building Automation Management System via AC500 to central and floor or room level functions guarantees efficient integration and best fit function of critical building systems, securing automation investment for the future. ABB's automation products can include control and monitoring of all up-to-date assets in a building like e.g. solar panels and integrate them to the energy management including e.g. storage and scheduling or shedding of loads. Overall this reduces consumption and maintenance costs, thereby considerably increasing the cost-effectiveness of buildings.

Monitoring and control

In commercial buildings the reliable operation and control of critical functions like doors, access systems, escalators and elevators is important

for e.g. a safe and secure operation even in emergency situations. AC500 can also control, monitor and interlock the electrical switchboards as well as all subsystems and their functionality and provides valuable information in case of energy loss on some feeders or malfunction. It can enable monitored and available backup power systems to kick in and service personnel to respond and fix errors rapidly. In case of problems AC500 can manage emergency lighting and provide 24/7 availability to protect people in the building.

Access control and monitoring of charging stations in parking spaces is another asset of AC500 which can be included in the energy management and monitoring locally, remotely or via cloud services.



Central HVAC, room and lighting management

ABB's KNX devices can control heating, cooling and lighting systems at room and floor levels and communicate directly also with central controllers like AC500. Such an integrated system can respond e.g. to sunshine thus ensuring optimal lighting and heating in every room individually, based on detected motion or absence in rooms. CP600 control panels can display the energy consumption of the individual rooms. Local or remote display is possible. With our integral solution, substantial energy savings can be achieved making your investment more profitable.

Reliability and scalability

In critical building applications, such as data centers, hospitals, airports or railway/metro stations, reliability of the installed automation solution is key to a safe, productive and cost-efficient operation.

For example in a hospital, reliable function and uninterrupted power supply during surgery are essential for the safety of patients and their treatment. ABB's AC500 addresses these concerns by offering the required special features like multiple communications, high-availability as well as hot swap features. These features are vital to protect surgeons and patients from external impacts causing unforeseen downtime in the operation of the building automation system.

Communication and openness

AC500 as an open communication platform can connect to Building Management Systems or field devices via various protocols, increasing usability, including OPC UA, BACnet and KNX protocols beneath many others.

With the proven ABB i-bus® KNX system expanded by AC500, it is possible to automate all building automation functions and combine them via BACnet into a single solution with the Building Automation System across all levels.

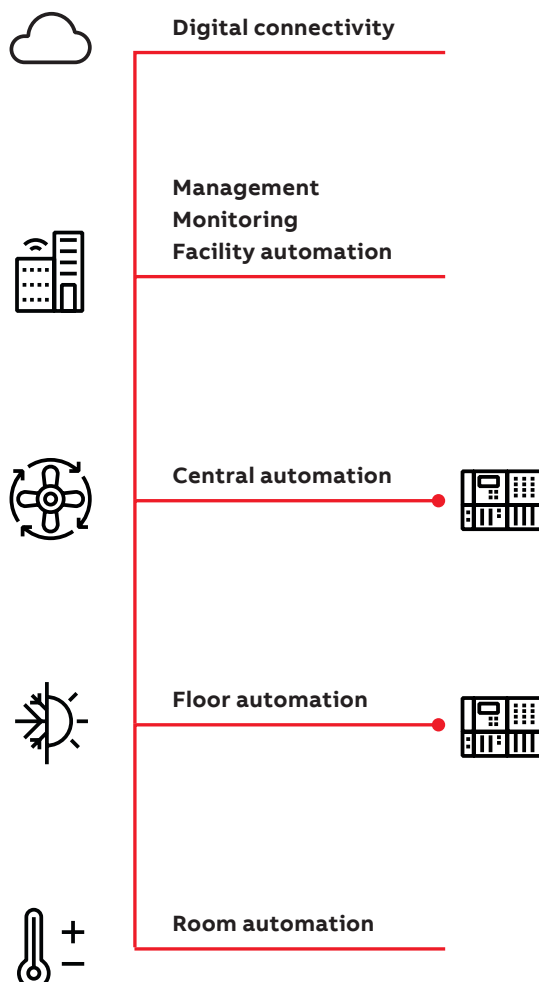

Application descriptions

Building automation with AC500, KNX and BACnet

AC500 as freely programmable controller, gateway or monitoring and visualization device

Easy creation and reuse of automation software in building automation by using the IEC 61131 standardized programming languages and library philosophies.

Use the AC500 PLC and S500 I/O for modular control e.g. for advanced energy efficient, safe and secure operation and monitoring tasks, from small to largest buildings.

Use the AC500 communication capabilities with other fieldbuses and protocols to connect, control and monitor the large portfolio of ABB components such as other low voltage products, ACS drives, motors, substations or connect them with building automation systems and the cloud e.g. with BACnet and OPC UA.

Use the AC500 and CP600 visualization capabilities for powerful local or remote monitoring across all levels.

Use KNX connectivity to add communication capabilities of the proven ABB i-bus® KNX devices like e.g. Dali, M-Bus etc. to the PLC automation level.

Seamless solution

Everything in one system from room to central building functions, based on

- KNX and its efficient engineering by integration of ETS and Automation Builder.
- BACnet (IP and MS/TP) with comfortable configuration in Automation Builder.

01 Integrated engineering workflow

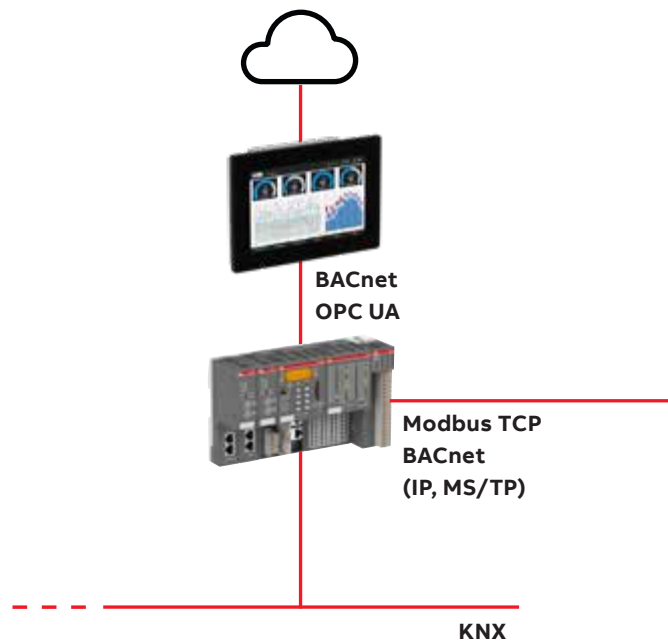
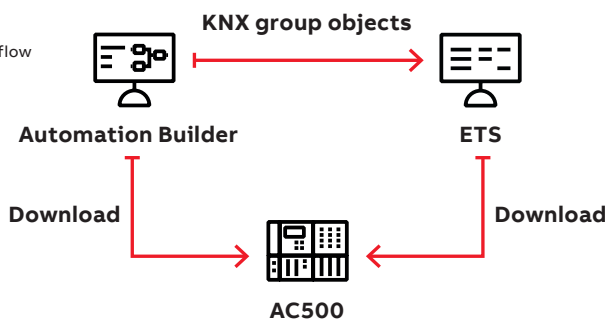



HVAC application

Heating, ventilation and air-conditioning technology is made up of various systems, often spread on room, floor and central levels that can now be integrated into a single system with the same integrated engineering to enable optimization across all levels.

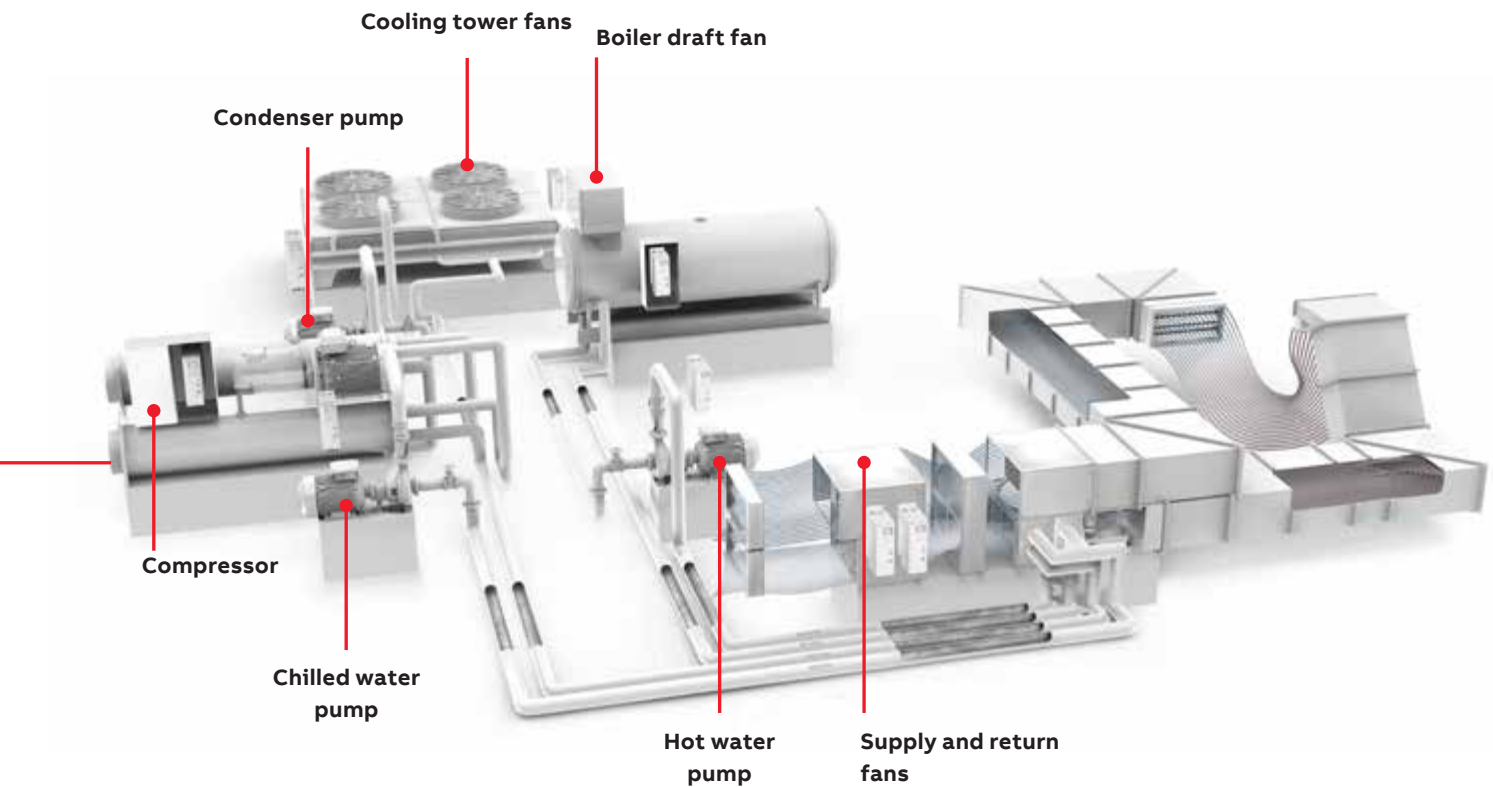

Application descriptions

AC500 HA offers hot standby redundancy

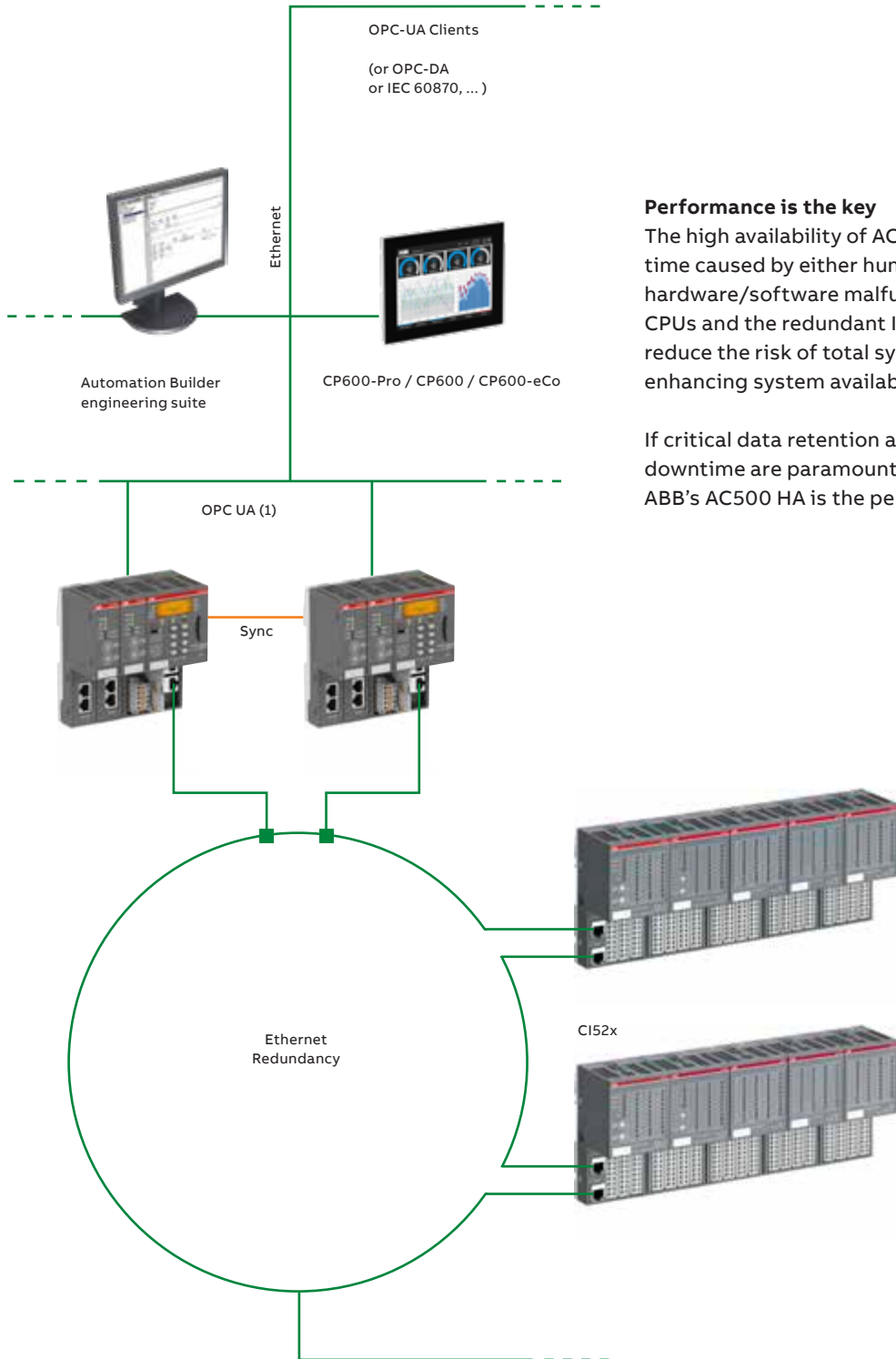

Performance is the key

The high availability of AC500 HA prevents downtime caused by either human error or cabling/hardware/software malfunction. Redundant CPUs and the redundant I/O communication reduce the risk of total system failure, thus enhancing system availability.

If critical data retention and the avoidance of downtime are paramount to your application, ABB's AC500 HA is the perfect solution.

(1) AC500 V3 CPUs only

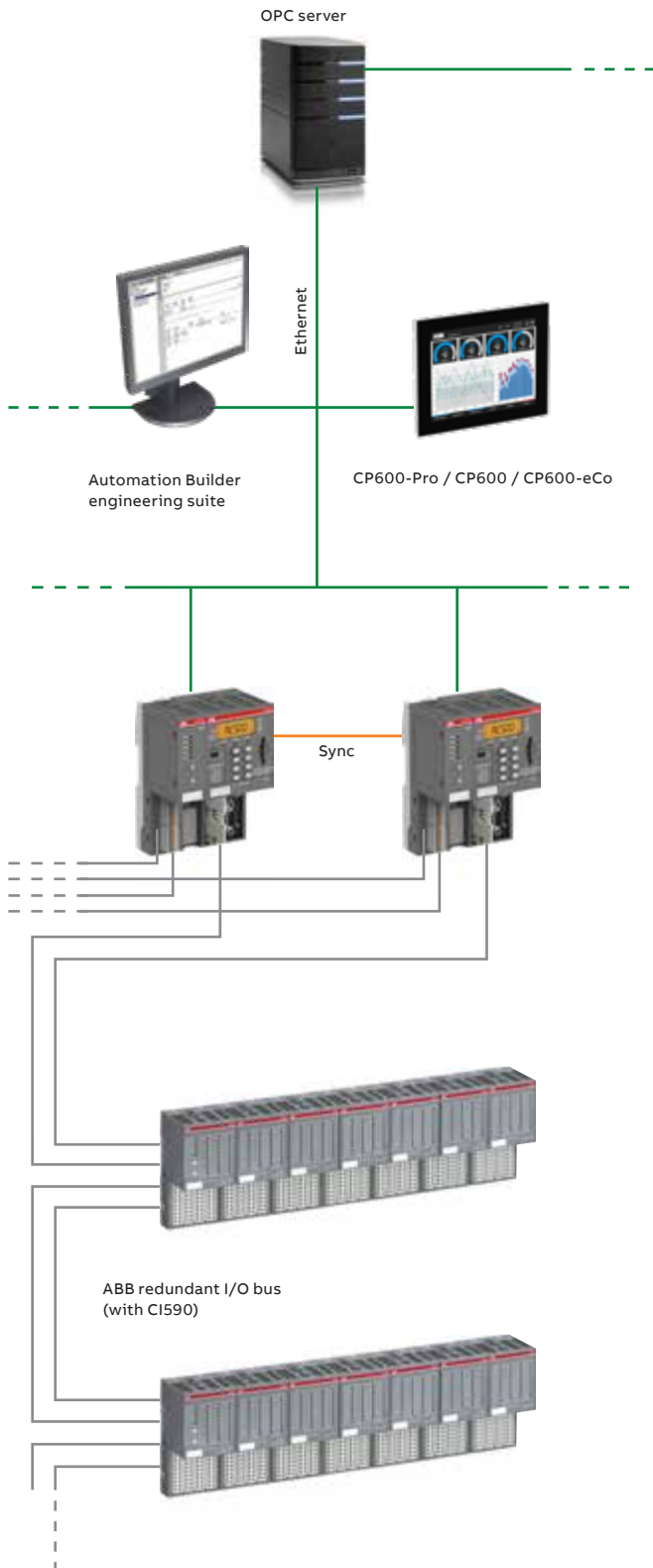

What are the benefits of AC500 HA for your high availability solution?

- Hot standby: Both CPUs (and all communications) are hot: Permanently running in parallel, continuously synchronizing each other and monitoring the system. If the primary CPU is stopped, powered off or crashed, or if an I/O communication/cable has failed, the other hot standby CPU takes over immediately by adopting primary status.
- Higher resource utilization, no downtimes caused by cabling/hardware/software failure thanks to redundant CPUs and redundant communication to I/O and SCADA/HMI.
- Cost efficiency and easy system maintenance through the use of standard hardware.
- High availability is provided with standard CPUs. Cost matching hot standby quality for small or large systems.
- Scalable in both variants: CS31 redundancy bus or Ethernet.

Application descriptions

Hot Swap of S500 I/O modules for increased availability



Replacing S500 I/O modules while the system is running

The hot swap terminal units TU516-H, TU532-H and TU542-H allow no-load hot swapping of S500 I/O modules during operation. When replacing a S500 I/O module the other modules in the cluster continue operating.

This capability is available for an I/O cluster with the following fieldbuses:

- PROFIBUS
- PROFINET
- Modbus TCP

Hot swap terminal units can also be used in I/O configurations attached to AC500 CPU modules.

Hot swap terminal units can be mixed with all normal terminal units (except safety terminal units) in the same configuration, when only specific modules need to be hot swapped.

The hot swapping feature is also available for extreme condition variants of S500.





Permanent wiring

Due to the construction of the S500 system, the wiring remains untouched during hot swap. There is no need to remove terminal blocks.

A S500 I/O module can be removed and replaced while the other modules in the configuration continue operating.

As soon as a module is re-inserted, it will be configured automatically and put into operation.

Applications

Hot swap is needed in hybrid applications when the control system must not be switched off during the replacement of a module.

Application descriptions

S500 I/O modules run with various controllers

S500 remote I/O

The availability of different fieldbus communication interfaces makes it easy to use S500 I/O modules as remote I/O for nearly any PLC and PC. The S500 remote I/O station consists of a communication interface and I/O modules. The smallest configuration can be just the communication interface with the onboard I/O channels. Communication interfaces are available for the following fieldbuses:

- PROFIBUS
- PROFINET/PROFIsafe
- EtherCAT
- Modbus TCP
- CANopen
- ABB CS31 System Bus

Easy engineering

The electronic configuration files that are provided by ABB for different fieldbus systems make it easy to configure the S500 remote I/O station in your engineering tool. The files such as GSD and GSDML are available for download at www.abb.com/plc. For Modbus TCP remote I/O stations a dedicated configurator is included in Automation Builder and for larger applications a Bulk Data Manager tool can be used.

AC500-eCo CPU as S500 remote I/O

When the AC500-eCo compact CPU is used as remote I/O, it can be programmed with Automation Builder for local intelligence while communicating via the open protocols Modbus TCP or Modbus RTU with a CPU that will then be the master of this intelligent remote I/O station. The AC500-eCo CPU can be expanded by I/O modules from the S500 and S500-eCo range.

Third party PLC, IPC or machine controller

Controller can also be an IPC with ABB Ability™ for data center

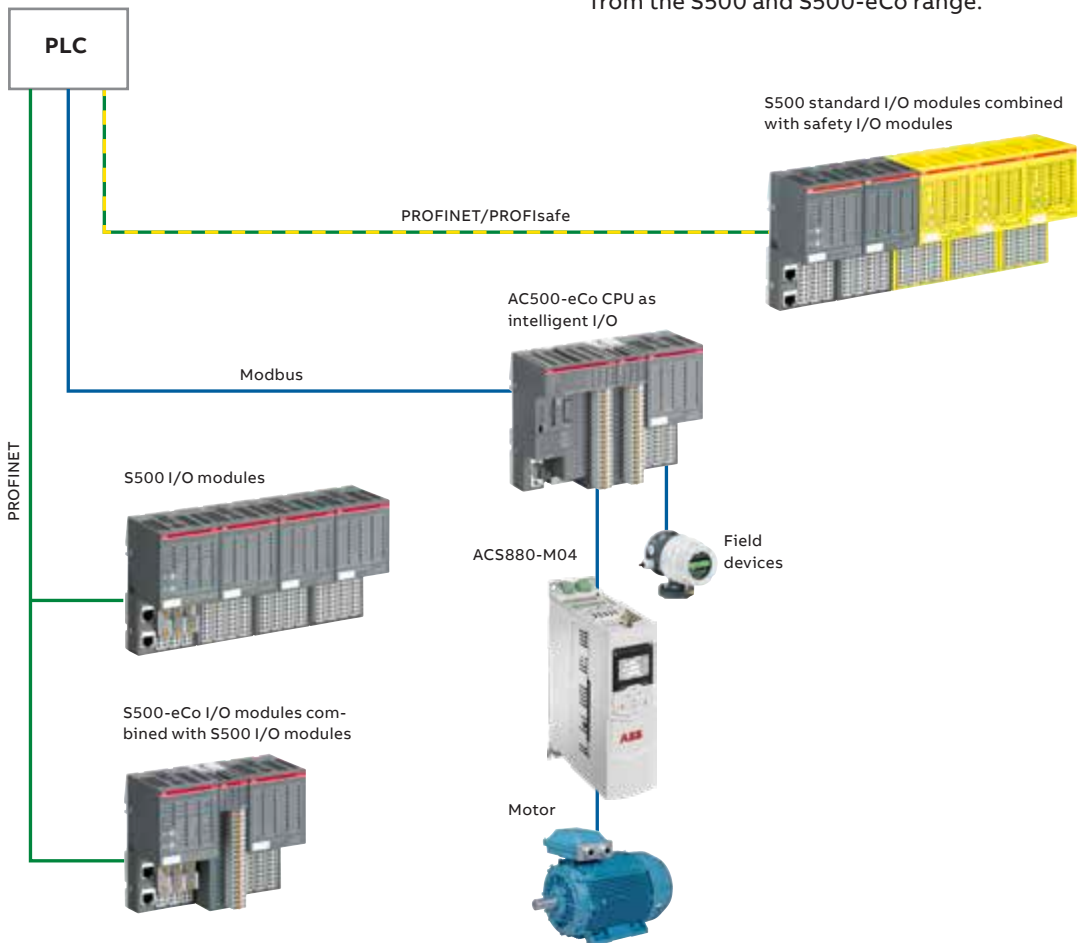

S500 remote I/O with Modbus TCP

ABB provides a configurator in the Automation Builder tool, which allows the configuration of Modbus TCP I/O stations with the communication interfaces CI521-MODTCP or CI522-MODTCP in the same style as the AC500 configuration. For larger applications a Bulk Data Manager tool can be used. The configuration can be stored in the communication interface, which allows using the configured station with any PLC or PC that supports Modbus TCP. This e.g. allows the use directly on other controllers or monitoring systems as e.g. ABB Ability™ Data Center Automation or external systems.

Thanks to the Modbus feature that allows several masters to exchange data with the same slave, it is possible to use the I/O station as shared devices with up to 10 PLC CPUs.

The Modbus masters can access the process data of the I/O stations in two different ways:

- Fixed mode: each I/O module in the station uses a separate register address range, which requires separate Modbus read/write operations for the modules in the station.
- The dynamic mode allows to pack the data of all I/O modules in the station in one data structure that can be exchanged in one single read/write operation.

S500 remote I/O with PROFINET/PROFIsafe

Simply extend your control system with ABB standard and safety I/Os to simplify wiring, reduce operating costs and benefit from the unique features of our safety I/O portfolio to increase the productivity of your machines.

For more information about safety applications, please see application description Embedding safety I/Os in ABB robots on page 226.

S500 in hybrid applications with AC 800M Controller

The communication interfaces for PROFIBUS and PROFINET facilitate the integration of S500 as remote I/O stations in the System 800xA AC 800M family of controllers. System redundancy is supported with PROFINET. The configuration is integrated into the Control Builder M engineering tool.

Hot swap of S500 I/O modules is possible when these are mounted on hot swap terminal units.

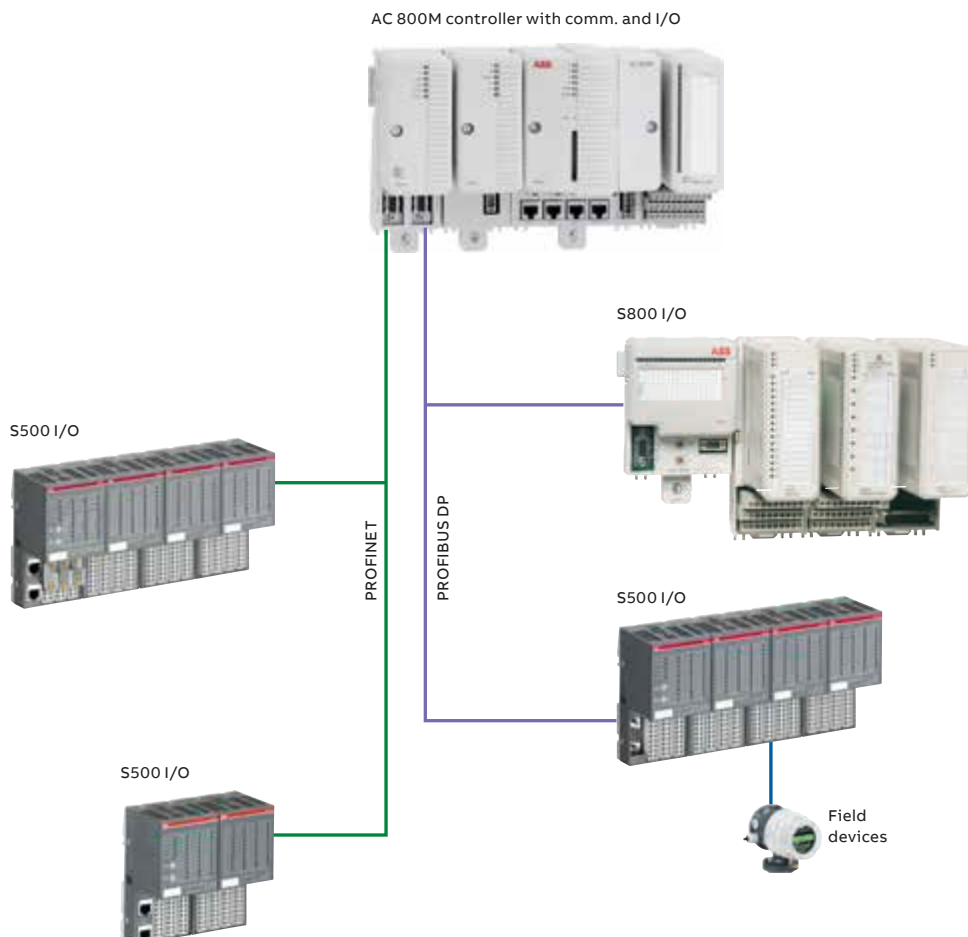

Application descriptions

AC500 PLC integration in ABB Ability™ System 800xA

Integration of AC500 PLC into System 800xA

The AC500 PLC hardware can be used for automation of process modules while the operator benefits from user experience in System 800xA. Proven libraries are provided for System 800xA and AC500. This allows programming control tasks in the AC500 PLC while System 800xA is the operator interface. For large distributed projects, many AC500 PLCs can be connected to a System 800xA node.

Process Control objects

Twelve objects are available which cover the following functionalities:

- Digital and analog setpoints
- Analog measurement with threshold alarm functions
- Valve control
- Motor control with or without variable speed drives
- Proportional integral controller

Communication between System 800xA and AC500 PLC

Communication between the AC500 function blocks and the objects in System 800xA uses the PLC Connect option of System 800xA and the AC500 OPC Server.

Simplified engineering

The Process Control Objects (PCO) library for AC500 V2 contains a function block for each object. The control task is engineered with the AC500 engineering tool Automation Builder. The communication between the objects in System 800xA and the function blocks in AC500 is configured with Bulk Data Manager, which is part of the System 800xA Engineering toolset. A library with ready-made symbols and faceplates for the objects is available for System 800xA engineering.

Integrated documentation

For engineering, the function blocks for AC500 include the user documentation. The faceplates provide multi-language support for the text elements and allow adaptation of the color codes of the elements to the preferences of the application.

Availability

The Process Control Objects Library (PCO) for AC500 V2 is available in Automation Builder as of version 2.2.3. The Automation Builder installation also contains the required OPC server. The corresponding 800xA PLC Object Library for 800xA or Compact HMI can be ordered via the 800xA 6.0.3 add-on features list.



—
System 800xA and
AC500 PLC network
architecture



Network

Compact HMI for local operation

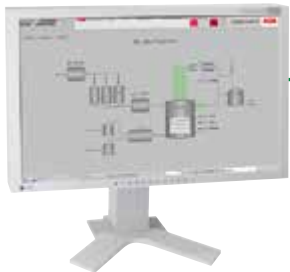

CP600 HMI
for local operation



Control of process
in AC500 PLC



Application descriptions

Condition Monitoring with AC500 PLC

Controller integrated or stand-alone condition monitoring

The AC500 condition monitoring module FM502 is a natural part of the AC500 platform and Automation Builder engineering suite, and can be used in different condition monitoring concepts, stand-alone or control integrated.

Due to the easy programming in PLC languages, it is usable for a variety of use cases and is especially suitable for plant, line and machine builders as easy extension of their offering.

If controller integrated

- it enables at very reasonable cost
- the best prediction horizon as it can measure online, when best measurement quality is given without scheduling production interruptions
- while continuously protecting the application in real time e.g. with the same or other sensor(s).
- Further inputs can be used as fast data logger e.g. precisely documenting process quality.

Therefore it is not only able to continually check the mechanical components but also gives fast protection for spontaneous and large failures even while measuring. The condition monitoring mode creates a database internally or externally for predictive maintenance. Automatic and user assisted responses can be enabled to prevent costly consequences including total failures.

As many as 16 vibration sensors + 2 encoder counters can be connected.

The recorded condition monitoring data can be stored in the CPU flash disk before communication or directly analyzed. Higher level indicators can be calculated and communicated to a local or remote HMI or database system.

Predictive performance for your process or machines

- Easy and cost saving integration of condition monitoring into the AC500 platform.
- Early detection of mechanical damages.
- Fast protection from spontaneous failures.
- Even complex C-code analytics can be used locally for meaningful own performance indicators.
- Leads to optimized planning of maintenance instead of fixed, scheduled service and spontaneous repair.
- No additional system or fixed software for diagnostics and visualization needed.
- Easy storage of the data, locally (4GB) or in remote servers and databases.
- Ideally suited also for retrofit of older equipment, as it can make use of mechanical reserves of still valuable equipment.



— AC500 Condition Monitoring module FM502-CMS: Controller integrated or stand-alone CMS covering a complete drive train.

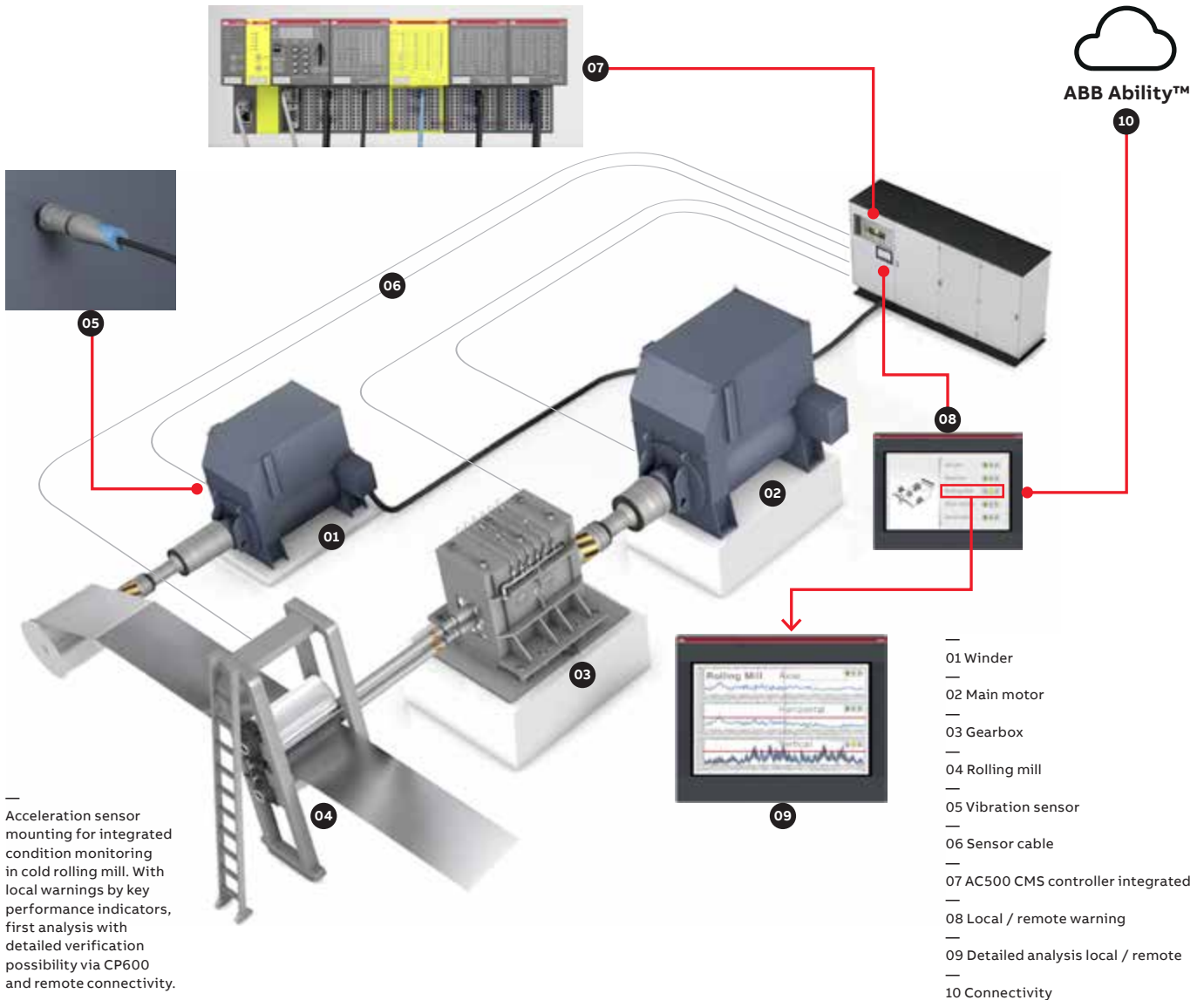
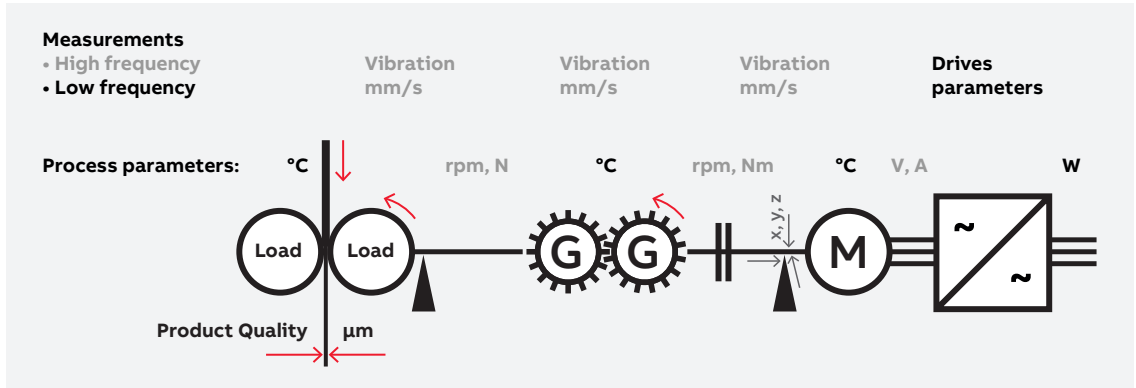

— Acceleration sensor mounting for integrated condition monitoring in cold rolling mill. With local warnings by key performance indicators, first analysis with detailed verification possibility via CP600 and remote connectivity.

Example: Cold rolling mill in steel processing:

- One FM502-CMS module can execute differently configured measurements at the same time and can be reconfigured at runtime.
- Several critical and unique components can be protected and condition predicted: Motors, gearbox, process (cold rolling mill).
- Production quality can be logged in parallel in real time.
- Remote diagnostics expertise and detailed analysis and reports only in case of warnings.

Please watch our videos on our ABB PLC YouTube channel:



www.youtube.com/user/abbplc

Application descriptions

Machine controllers based on AC500 PLC

From simple to high end motion applications

- Convenient PLC portfolio for diverse applications
 - Simple machine control with AC500-eCo PLC
 - Point-to-point motion with PTO outputs or Modbus communication with the drive
 - Mid-range applications with AC500 PLC
 - EtherCAT communication with the drive or remote I/O and cam-switch for synchronized motion
 - High-end motion application with PM595
 - Axis interpolation e.g. for Delta robot
- Easy integration and excellent scalability using Automation Builder
- Motion library for complex applications

Multi-axis motion coordination with EtherCAT

ABB's AC500 PLC using EtherCAT real-time bus delivers high performance for multi-axis control applications.

The AC500 PLC provides an industry solution with IEC 61131-3 programming and PLCopen motion functions in combination with ABB drives such as ACS880-M04 fitted with the FECA-01 EtherCAT module for higher power axes or ACS380 drives or with MicroFlex e190.

This popular high-performance motion bus provides simple 'daisy chain' connection.

- EtherCAT multi-axis coordinated motion
- 01 AC500 PLC
- 02 CP600 HMI
- 03 Pluto Safety PLC module
- 04 MicroFlex e190
- 05 MotiFlex e180
- 06 ACS880-M04
- 07 ACS380
- 08 ACS880
- 09 S500 EtherCAT I/O

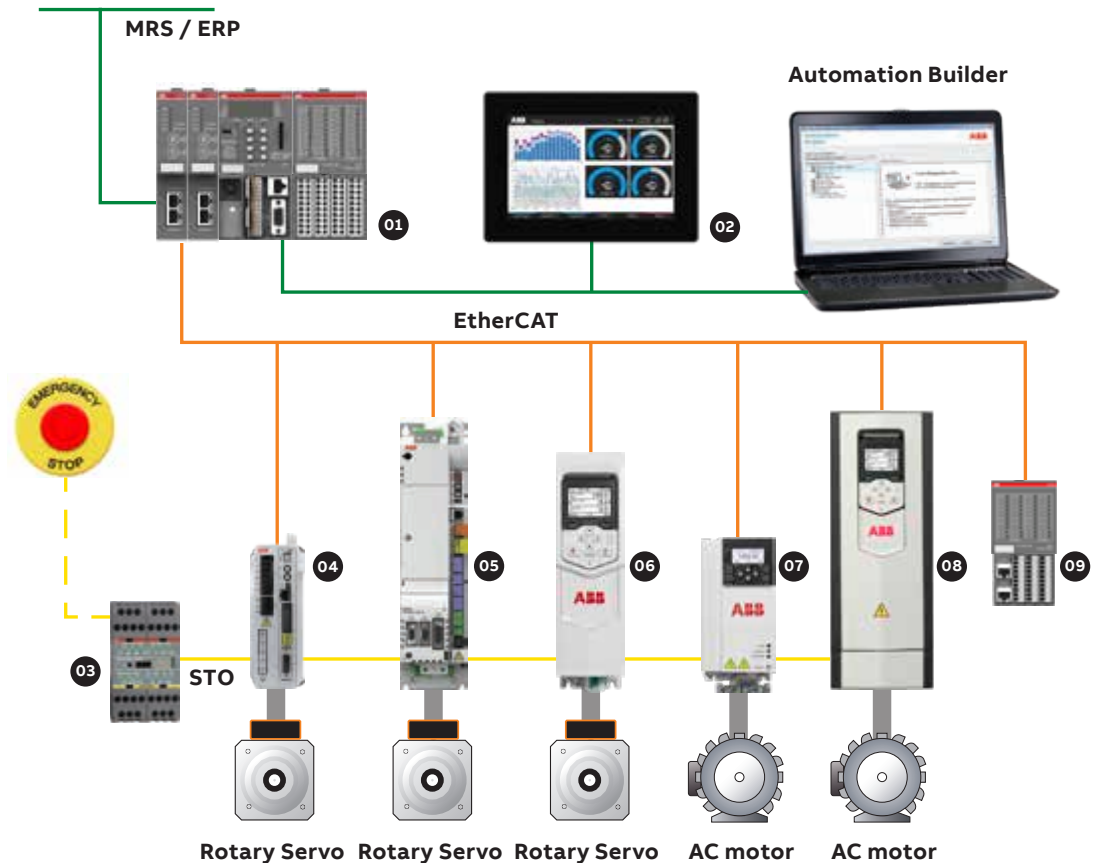

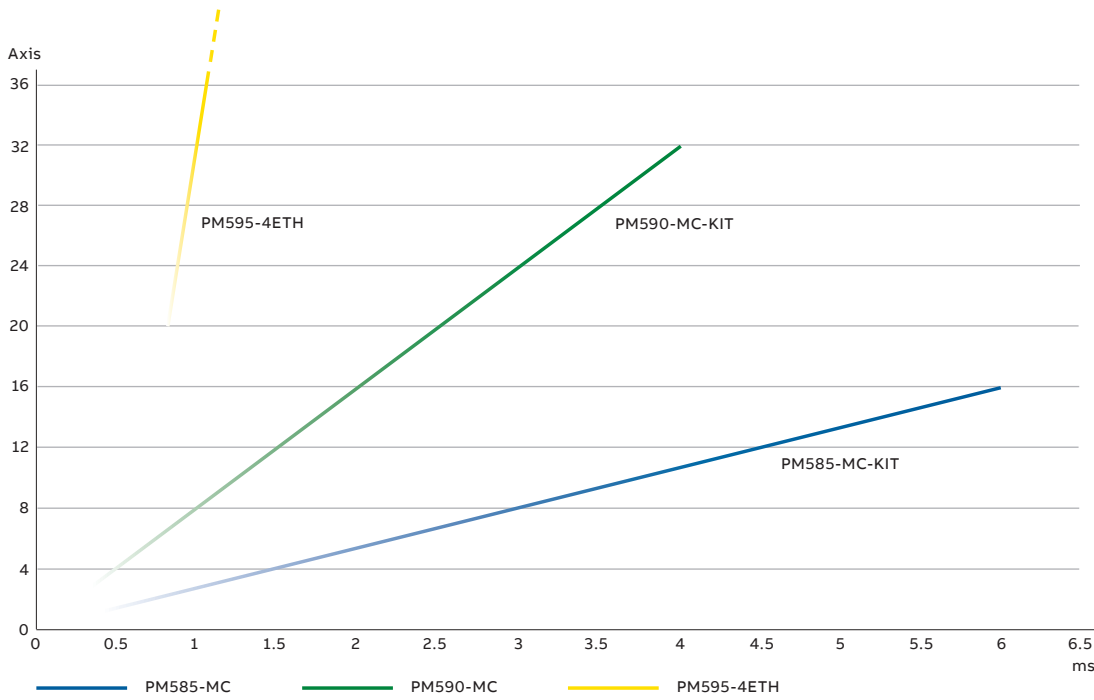

01

01 Number synchronized Axis / ms

EtherCAT AC500 machine controller kits

In order to simplify your application, ABB offers products for the implementation of machine control or motion control applications. These products can be purchased individually or as a kit.

Two available EtherCAT kits contain the components required for your application.

Depending on the required performance, the kit provides a powerful CPU, an EtherCAT master communication module and the respective terminal base.

The kit can be expanded using standard I/Os, other communication products or software solutions.

AC500 Machine controller kits

Program memory kB	Cycle time in μ s per instruction min. Bit/Word/Float. point	Integrated communication	Type	Order code	Price	Weight (1 pce) kg
1024	0.004 / 0.008 / 0.008	PM585-ETH, CM579-ETHCAT, TB511-ETH Ethernet (2), 2 x serial, EtherCAT Master	PM585-MC-KIT	1SAP140500R0379		0.500
2048	0.002 / 0.004 / 0.004	PM590-ETH, CM579-ETHCAT, TB521-ETH, TA524 Ethernet (2), 2 x serial, EtherCAT Master	PM590-MC-KIT	1SAP150000R0379		0.500

AC500 CPU PM595

Program memory MB	Cycle time in μ s per instruction min. Bit/Word/Float. point	Integrated communication	Type	Order code	Price	Weight (1 pce) kg
16	0.0006/0.001/0.001	2 x Ethernet (2 Ports switch), 2 x Ethernet (2), 2 x serial	PM595-4ETH-F	1SAP155500R0279		1.050

Application descriptions

Real-time Ethernet functionality

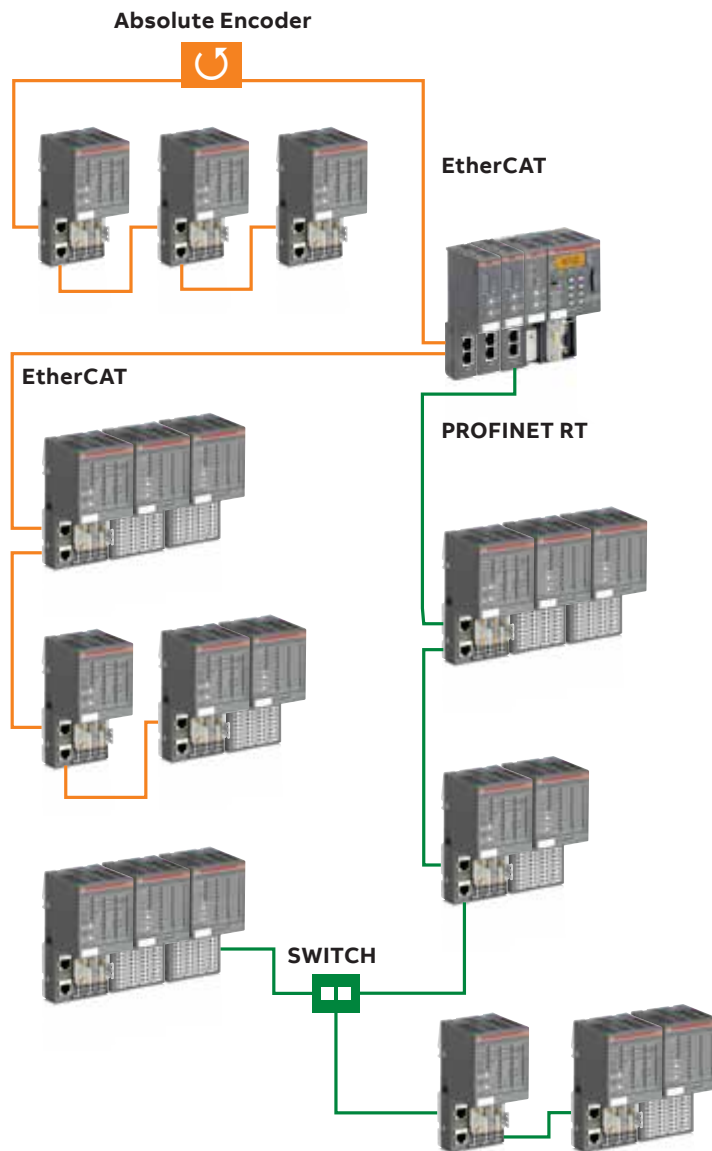

RT-Ethernet modules

Modules are available with two different communication protocols based on Ethernet (PROFINET I/O, EtherCAT). Master couplers connect AC500 CPUs to remote I/O modules. Various interface modules offer the connection of decentralized I/O modules to the real-time Ethernet networks.

Cam-switch functionality

Modules based on the decentralized real-time EtherCAT interface technology with integrated I/Os and programmed with PLCopen function blocks are available.



Application descriptions

Safer, greener and more productive with AC500-S safety PLC

PLCs with in-built functional safety and fail-safe condition monitoring are the unsung heroes of many renewable installations like wind turbines, electric battery-operated AGVs and hydrogen tank stations.

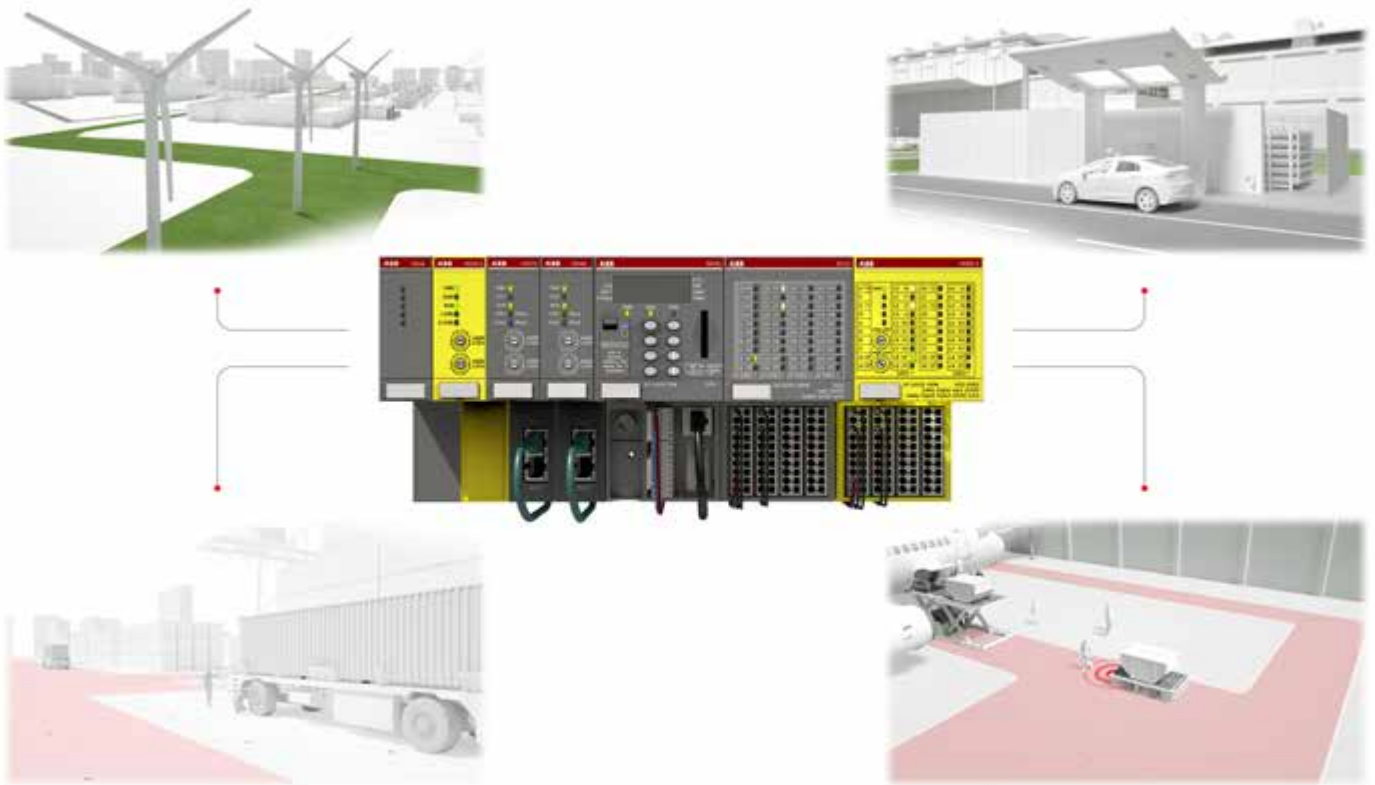

A safety PLC plays an important role in renewable energy applications

Using programmable logic controllers (PLCs) to control wind turbines or direct solar arrays has been a common solution for many years. What is not yet fully appreciated is the failsafe condition monitoring and advanced functional safety capabilities built within today's PLCs and how they can be applied to renewable applications. Not everyone has grasped the importance that functional safety plays in renewable energy applications and the influential role that a safety PLC can play.

Renewable applications often require complex safety calculations driven by the need to process vast amounts of information to safely supervise the permissible range for temperature, pressure, charge rate, vibration level or position and speed tracking in real-time. Simultaneously, there is a need to safely monitor these complex renewable processes and/or machine characteristics. Ideally placed for this are safety PLCs, with support for trigonometric functions, floating-point calculations, PROFINET/PROFIsafe communication and structured text (ST) for safety programming.

Wind turbines

Wind turbine safety is becoming increasingly important. In many countries, regulations stipulate that safety during wind turbine operation is critical to prevent accidents due to potential wind turbine collapse.

In addition to a state-of-the-art wind turbine safe control, the ABB AC500-S safety PLC with condition monitoring provides fail-safe condition monitoring of vibrations within the turbine's tower. This enables advanced safety functions to be implemented within wind turbines to avoid structural damage which could lead to accidents.

Automated guided vehicles

Airports and harbors are becoming the epitome of green design, with shore-based wind turbines powering, for instance, the charging stations used to replenish electric battery-operated automated guided vehicles (AGVs) transporting goods.

The safety PLCs can restrict battery-operated AGVs to designated areas creating safe zones where workers can move about freely. Unable to enter these restricted areas, safety barriers no longer need to be able to withstand the full-force of an AGV, leading to a more open collaborative environment. In areas where the two must mix, the PLC can take input from the AGV's laser-scanner to safely stop the vehicle if it detects a worker or other object in its path.

The safety PLC provides floating-point calculations and trigonometric functions to implement even the most complex mathematical calculations in real-time. These include safely monitoring restricted safety areas for battery-operated AGVs and collision detection.

Hydrogen tanks

To go further afield, people are increasingly turning to hydrogen fuelled vehicles to provide easy long-distance travel with much lower emissions than with conventional fuel like gasoline, gas, etc. Hydrogen is seen as an alternative to electric vehicles, featuring smaller batteries and generators, yet able to be used for longer distances. The key to this ease is the speed at which a vehicle can refill its tanks with this zero-emission fuel.

Critical to the safe operation of a hydrogen fuel tank is the need to precisely control the pressure and temperature. The tanks are packed with sensors monitoring these parameters and the PLCs provide fast processing speed to handle the large range of pressure and temperature calculations including safety functions like hydrogen leak detection, smoke detection, high pressure protection of inlet and outlet, etc. The fuelling stations use safety PLCs to precisely monitor the pressure, temperature and tank integrity, whilst providing controlled shut off of the safety valves in the event of a problem.

Please watch our videos on our ABB PLC YouTube channel:



www.youtube.com/user/abbplc

Application descriptions

Embedding safety I/Os in ABB robots enhances man-machine collaboration

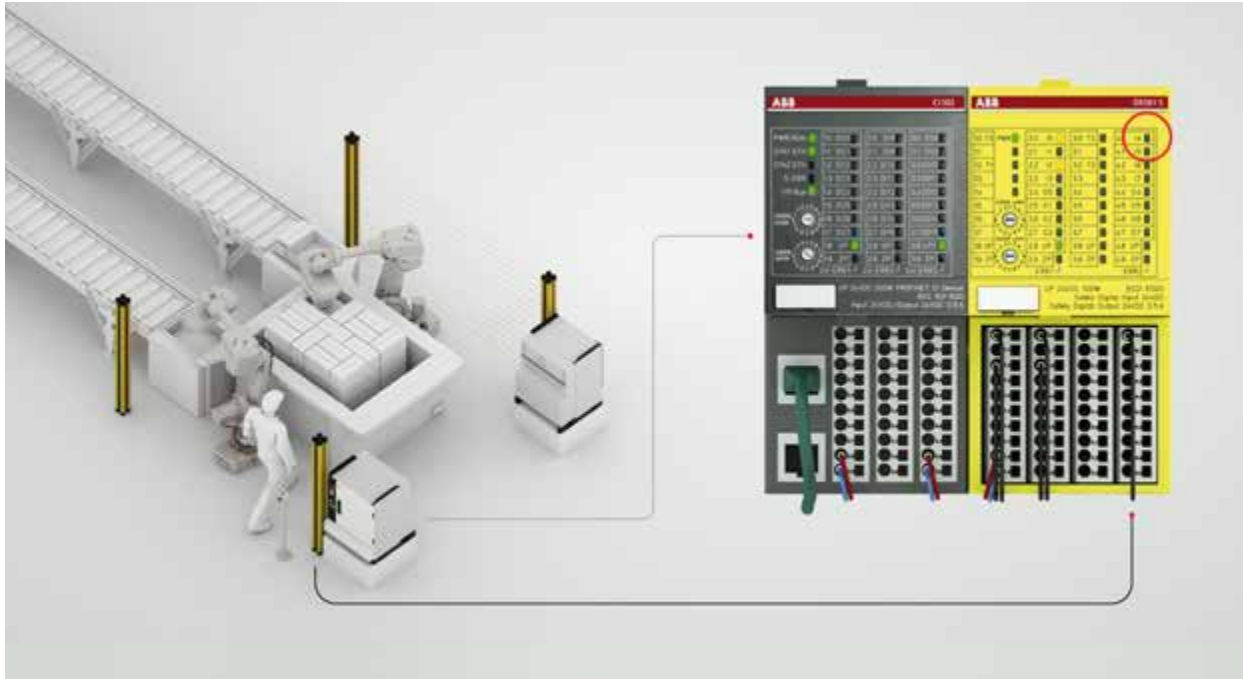

Integration of safety I/Os

ABB is embedding S500 safety I/Os within its series of robot controllers to improve the flexibility, safety and reliability of collaboration between robots and people, which prevents unnecessary disruption to production. Simply extend your control system with ABB S500 safety I/Os to save wiring efforts, operation costs and use unique features of our safety I/O portfolio to increase your machine productivity.

A light curtain, laser scanner, safety mat, E-stop and acknowledge button, for example, are connected to ABB's S500 safety I/O module, which is integral to the ABB robot controller. Should a human enter the robot's cell to undertake maintenance, the safely-limited speed of the robot can be triggered, if permitted, as opposed to a safe stop. The robot moves very slowly and within

the pre-defined safe work zone using ABB's SafeMove2. Once the human leaves the cell, the robot can resume its faster operational speed with or without acknowledgement, depending on the used safety sensors.

Cost-efficient solution

As the S500 safety I/Os are controlled by the safety module inside the robot controller, there is no need for third party stand-alone safety PLCs to be used. This saves costs as the combination of I/O and robot controller frees up space that would normally be needed for a separate cabinet. It also reduces the time associated with the set-up and operation of robotic production cells. This standardized solution leads to reduced spares, less wiring and lower operational costs as well as easy engineering through common diagnostics.

Enhanced functionality

- More test pulse outputs on S500 safety digital I/O modules ensure higher degree of fault diagnostics and reaction, which results in higher safety integrity level for safety functions in the machine.
- Each safety I/O channel has not only process state LED but also fault-diagnostic LED which significantly simplifies maintenance work and, thus, save your operation costs.
- Extreme condition (XC) modules are available (-40 to +70 °C, high vibration and shock requirements, etc.), which allows cost-savings in engineering and operation.
- Fool-proof protection implemented in all safety I/O modules (reverse signal or power supply polarity, wrong module placement, short circuit etc.), to avoid damaged modules due to wrong wiring.

More flexibility

- A single safety I/O channel can be individually reintegrated, which may provide higher machine availability in many customer cases.
- Front panel rotary switch for PROFIsafe address ensures less maintenance effort because you can see all pre-set PROFIsafe addresses directly looking at the front cover of safety I/O modules (no more need to disassemble safety I/Os).
- Built-in module power supply (no additional 24V DC power supply needed), which makes your power supply connections much simpler.

Please watch our videos on our ABB PLC YouTube channel:



www.youtube.com/user/abbplc



Application descriptions

Safe communication between safety CPUs

— 01 A modern distribution center comprises several independent systems including conveyor and lift systems, robotic sorting and palletizing processes, together with autonomous guided vehicles, or AGVs, and automated stacker cranes that lift pallets to and from the high bay storage systems. Each system needs to exchange its control and safety data via a central control system or distributed control system in an efficient and reliable manner so as to maintain productivity and minimize downtime.

Real-time exchange of high volume process and safety data

ABB has moved from using just one central PLC controller to multiple controllers capable of communicating with many machines in real-time. Now each machine controller can exchange big volumes of process and safety data in real-time to more than one central control system simultaneously.

New safety CPU modules SM560-S-FD-1 (-XC) and SM560-S-FD-4 (-XC) that can now function as both a safety controller and a safety device are launched by ABB. The modules, when used with ABB's AC500/AC500-S Programmable Logic Controller (PLC), feature the ability to exchange process and safety data, not only from one controller to multiple devices but also from one device to multiple controllers, using PROFINET/PROFIsafe shared device functionality.

Now hybrid interconnected PLC control systems can extend traditional centralized or distributed control. As such, each controlled machine can deliver high volumes of process and safety data in real-time, simultaneously, to several central control systems.

This solution replaces gateways which are expensive, take valuable control cabinet space and because they are limited to only 12 bytes of safety data per gateway, cannot communicate in real-time with large safety data volumes. With the new solution, a maximum of 1440 bytes of process data including up to 384 bytes of functional safety data can be allocated for up to four PLC controller systems, thereby providing faster reaction to optimize the production and improve the predictive maintenance that leads to less downtime.

— 01

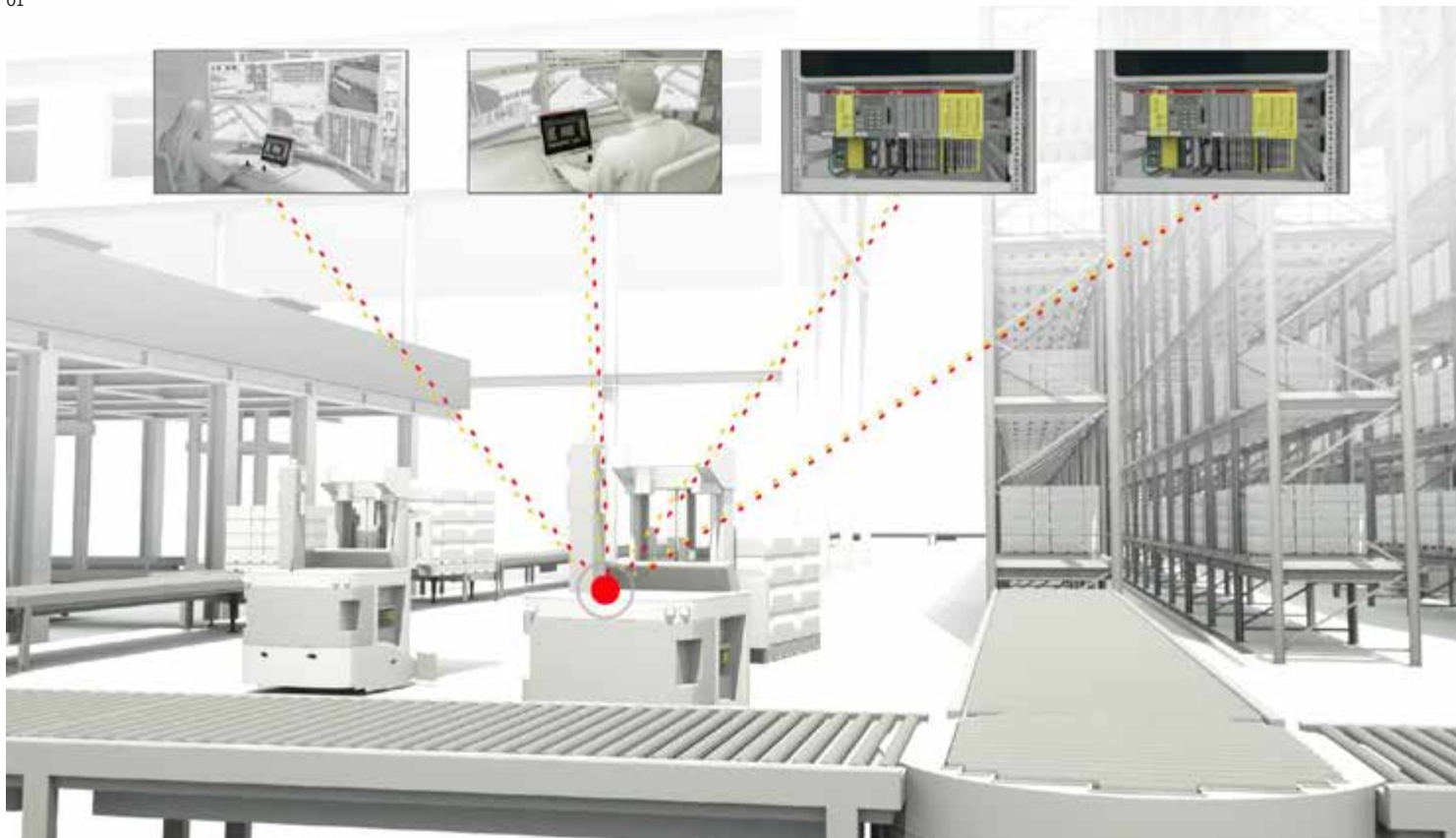

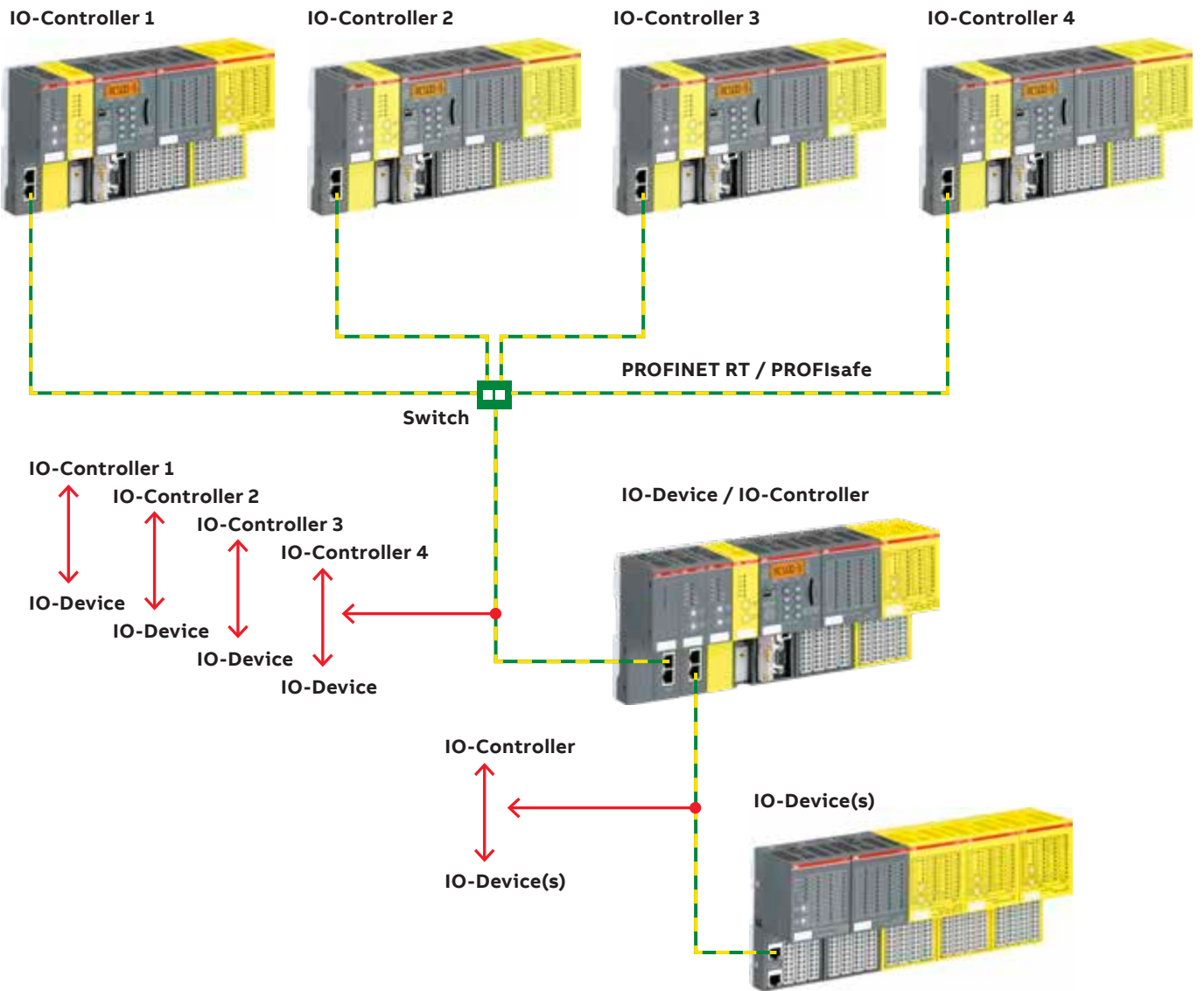

Please watch our videos on our ABB PLC YouTube channel:



www.youtube.com/user/abbplc

Application descriptions

Triggering safety actions using standard HMI

With ABB's AC500-S safety PLC, standard HMIs such as control panels and mobile devices can be used to alter functional safety control functions in industrial applications. ABB has developed a method of using standard human machine interface (HMI) products such as control panels, industrial PCs and mobile devices to reconfigure safety control functions.

Using ABB's AC500-S safety PLC, operators of equipment such as harbor and factory cranes, hoists, elevators, airport passenger bridges, automatic guided vehicles (AGVs), robots, mining and pulp & paper machinery can select, modify and amend their safety control functions. This allows them to achieve functional safety standard requirements while benefiting from the convenience and low costs of using standard HMIs.

Operators of these industrial applications need to reconfigure their safety control functions to adapt to changed application conditions and to optimize machine productivity. These reconfigurations, known as safety actions, are often performed using mechanical or electro-mechanical mode selector switches connected to the digital safety inputs of a safety PLC.

This method suffers from limited user-friendliness, inability to make modifications to switch layout and function, limited number of selection options and relatively high costs for the mode selector switches and digital safety input channels.

ABB solves these challenges by allowing standard HMIs, such as control panels, industrial PCs and mobile devices to interface with an ABB AC500-S safety PLC to carry out these safety actions.





Please watch our videos on our ABB PLC YouTube channel:



www.youtube.com/user/abbplc

Another example is in the selection of a crane, allowing it to be controlled remotely using the emergency stop located on the operator desk. A network links the AC500-S safety PLC in the control room with the safety PLCs at the cranes. The user in the control room can select, using standard HMI equipment, which of the cranes will stop if the emergency stop button is activated on the remote operator control station. Pressing the remote emergency stop button on the

operator's desk will therefore stop the selected crane only. Independent of the remote emergency stop function, all cranes still have their own local emergency stop controls.

The ability to select from a wide range of HMI products offers the user independence from any one vendor, a larger range of input options and greater flexibility to adapt the connections and layout of the HMIs.



PLC training and support Offering



ABB provides training and technical support guiding you to the ideal PLC Automation products for your applications. Supported by one of the world's most extensive global sales and service networks, we offer PLC and Automation Builder software training designed for engineering, operation and maintenance of PLC automation solutions.

Learn online through our video tutorials, eLearning, application examples or user forum and attend our classroom training sessions.

- ABB University course locator
- Application examples
- Channel partner program
- FAQ
- PLC on YouTube
- PLC Training and Support

For more information, please visit <https://new.abb.com/plc/training> or contact your local sales organization.

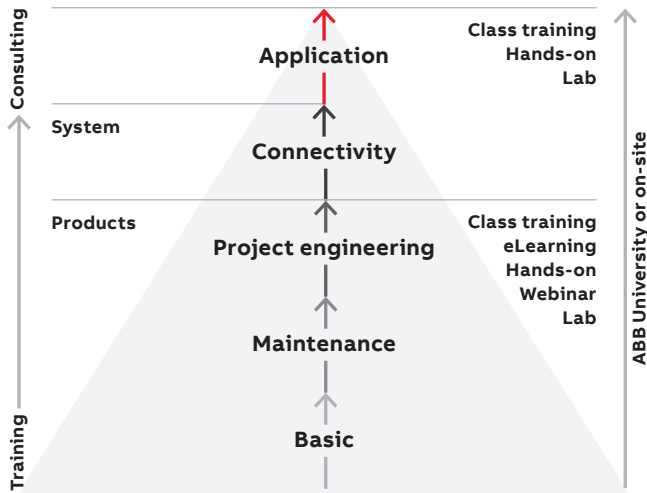

PLC training and support

Training cases

—
01 AC500 training case
For details, please
see page 96.

—
02 AC500-S training
case
For details, please
see page 178.

AC500 training cases help you to get familiar with
ABB AC500 PLC offerings and the engineering
tool Automation Builder.

For more information, please see
www.new.abb.com/plc/training.



02



01

Training cases	Description	Type	Order code	Price	Weight (1 pce) kg
AC500 V2 training case	PM583-ETH + TB521-ETH + CM579-PNIO + DA501 + CI502-PNIO + CP6607 + Case + 115-230 V AC power supply + Ethernet cables + demo program + SD memory card + simulation stand	TA515-CASE	1SAP182400R0002		7.0
AC500 V3 training case	PM5630-2ETH + TB5620-2ETH + CM579-PNIO + DA501 + CI502-PNIO + CP6607 + Case + 115-230 V AC power supply + Ethernet cables + demo program + SD memory card + simulation stand	TA5450-CASE	1SAP187700R0001		7.0
AC500-S Safety PLC training case	SM560-S, DI581-S, DX581-S, AI581-S, TU582-S with PM573-ETH and PNIO	TA514-SAFETY	1SAP182900R0001		10.0

PLC training and support

AC500-eCo Starter kit

AC500-eCo Starter kit

The AC500-eCo Starter kit helps you to get familiar with ABB AC500 PLC offerings and the engineering tool within a very short time. Learn how to connect and setup the components provided in the starter kit and how to program the PLC by means of several simple example applications. The starter kit comes with CPU, programming cable, digital input simulator and getting started manual. The latest version of the engineering tool Automation Builder is available via download. The getting started manual is integrated in Automation Builder.

Easy to use

The AC500-eCo from ABB is a range of uniquely scalable PLCs offering you unrivalled cost effectiveness for modern industrial automation applications. The AC500-eCo integrates perfectly into the AC500 family - this provides you with the option to build customized solutions based on the standard S500 and S500-eCo I/O range.

Easy to learn

Offering all of the advantages you would expect from the AC500 family of devices, the AC500-eCo delivers an impressive set of powerful programming features. In addition, thanks to the fact that ABB uses a standard IEC61131-3 based programming system for the entire AC500 family, it is a snap to learn and configure.

Ordering data

Each kit consists of CPU, programming cable and digital input simulator. The engineering tool is available for download at www.abb.com/automationbuilder.



CPU module in the starter kit	Programming cable (included)	Type	Order code	Price	Weight (1 pce) kg
PM554-TP-ETH	Ethernet	TA574-D-T-ETH	1SAP186200R0004		1.400

Cyber Security Information



Introduction

Cyber Security is one of the most important topics for ABB and its customers. With the adoption of Industry 4.0 and IoT more and more devices are connected with each other. This is the reason why the security of industrial automation and control systems becomes more and more critical. ABB aims to protect the data, integrity and availability of all AC500 PLC products from I/O modules to the engineering software.

How ABB PLC products meet security challenges

ABB takes all necessary measures to continuously improve the security of its products. These measures follow commonly accepted industry standards and practices and include, where technically feasible:

- Robustness testing, including fuzzing and flooding
- Vulnerability scanning for known vulnerabilities and exploits
- Security testing, including static code analysis or binary code analysis.

We highly recommend that all software, firmware, libraries and applications are kept up to date using the most recent firmware and software updates to keep your system and environment secure.

Before any deployment of standard and functional safety applications with ABB PLC products, an assessment for dangerous threats such as eavesdropping or data manipulation shall be executed. The security measures will depend on the selected security standard for the given application and implemented on the overall system level, for example, IEC 62443-3-3 “Industrial communication networks – Network and system security” standard, can be used.

Additional information

For additional information and support, please contact your local ABB service organization. For contact information, please write an email to plc.support@de.abb.com

Information about ABB’s cyber security program and capabilities:

<http://www.abb.com/cybersecurity>

<https://new.abb.com/about/technology/cyber-security/alerts-and-notifications>

In addition, you will find the AC500 PLC cyber security white paper below this link:
<https://new.abb.com/plc/documentsanddownloads>

PLC training and support

Application examples

ABB Automation Builder is the integrated engineering suite for machine builders and system integrators. ABB Automation Builder covers the engineering of ABB PLCs, safety, control panels, drives and motion. The application examples contain programming descriptions for different communication protocols and automation components.

CI52x-MODTCP modules, configuration and communication

This application example describes the configuration (TCP/IP address and parameters) of the CI52x communication interface modules with Automation Builder. The second part describes communication with the configured modules and an AC500 PLC.

AC500 BACnet IP, data exchange between 2 CPUs via the CP600 gateway

This application example demonstrates how to exchange data between PLC A and PLC B where both PLCs act as servers only. The trick is to use a CP600 panel as BACnet gateway. The panel acts as BACnet client.

Cloud connectivity

This application example shows data publishing from AC500 to Microsoft Azure. It is not limited to the AC500 part, but also includes a configuration example of the required Microsoft Azure components.

AC500 PROFINET, configuration and engineering

This application example describes how to configure and setup a PROFINET communication with Automation Builder V2.0.x. The detailed step-by-step instruction shows all necessary steps and describes the relevant parameters which have to be set carefully to establish a reliable and robust PROFINET communication.

The second part of this application example contains general information on e.g. cables, plugs, switches and network topologies which helps you realize your own PROFINET application project.

Use of AC500 CMS filters

This application example explains in an easy to understand way how to filter measured signals in two different ways and calculate the RMS value with the filtered signal.

AC500 license and IP protection for Codesys V2.3 libraries

The license protection of Codesys libraries aims at controlling the use of a library within the engineering context.

For more application examples, please visit <https://new.abb.com/plc/application-examples>



PLC training and support

Application notes

Triggering safety actions using standard HMI

The application note describes the AC500/AC500-S system configuration, programming approach, safety calculation and requirements for standard HMIs for triggering safety actions using them. Standard HMIs that support at least two different Ethernet-based communication protocols can be used. ABB recommends Modbus/TCP and ABB ETH. A mean time between failures (MTBF) greater than 22.5 years is required for standard HMIs to satisfy PL d (ISO 13849-1) requirements. HMIs with lower MTBFs may only satisfy PL c (ISO 13849-1) requirements.

AC500-S safety I/O DX581-S with ABB safety relays BSR23

The application note provides technical details on using the DX581-S safety I/O module with ABB BSR23 safety relays for the potential-free switching of 6 A / 5A (24 V DC / 250 V AC) electrical loads, such as big safety contactors or safety valves by means the AC500-S safety PLC. Typical wiring examples and information related to safety calculations are included. Explanations of using the PLCopen safety FBs delivered with the AC500-S safety PLC in the safety application program to supervise the state of safety relay contacts are provided.

Using DX581-S safety digital outputs with 2A 24 V DC electrical loads

The application note describes how the DX581-S safety I/O module developed for electrical loads with up to 500 mA 24 V DC can be used for switching 2A 24 V DC electrical loads such as big safety power contactors or solenoid valves. Details for wiring, channel configuration and safety calculation are provided.

Cyclic non-safe data exchange between the SM560-S safety CPU and the PM5xx non-safety CPU

This application note describes the project configuration, programming details as well as verification and validation steps for the optional use of cyclic non-safe data exchange via DPRAM between the SM560-S safety CPU and PM5xx. A fast communication and/or transfer of large data volumes (> 84 Bytes) via DPRAM between the SM560-S safety CPU and the PM5xx non-safety CPU is needed in some customer-specific applications such as cranes, hoists, AGVs (automatic guided vehicles), etc. to synchronize process data on both CPUs. The solution described in the application note with SF_CYCLIC_PM5XX_S_SEND and SF_CYCLIC_PM5XX_S_REC FBs allows data exchange with up to 2 kByte of process data between a safety CPU and a non-safety CPU in every program cycle.

For more information, please visit <https://new.abb.com/plc/programmable-logic-controllers-plcs/ac500-s>

<https://new.abb.com/plc/documentsanddownloads>



AC31 adapter for retrofitting existing AC31 applications

AC500 life cycle management

A long history

During more than 40 years in the PLC business, we have gained experience from hardwired, centralized and distributed PLCs to scalable PLCs. One of our previous product ranges, the AC31 series 90, was succeeded by the AC500 PLC platform.

For the protection of your investments and for ease of migration to the new AC500 PLC generation, ABB provides AC31 adapter modules based on AC500.

The modules have the same footprint, cabling and features as the previous AC31 series 90 products with up-to-date AC500 hardware.

AC31 adapter modules can replace existing AC31 devices with either direct compatible e.g. I/O modules or need adjustments with a new user program for the CPU using Automation Builder software.

Main characteristics and architecture

The connection locations do not differ from the predecessor hardware and the number or type of I/O channels are comparable. For remote I/O products on the CS31 bus, I/Os of an existing field application can be modified without having to change the application or configuration. New modules can be configured with DIP switches.

Replacing the AC31 PLC with the 07KT98-x-AD PLC requires to rewrite the application program using the Automation Builder engineering suite.

Advantages at a glance

- Compatible with the existing AC31 series 90 remote I/O-modules, in some cases with 1-to-1 replacement in the field, no change of application configuration required.
- Footprint identical to predecessor hardware.
- Automation Builder for PLC programming.
- Standard AC500 modules for seamless migration from AC31 to the new AC500.
- Longer life cycle of AC31 through migration to new solution.

Ordering details

For more information, please contact your local sales organization.

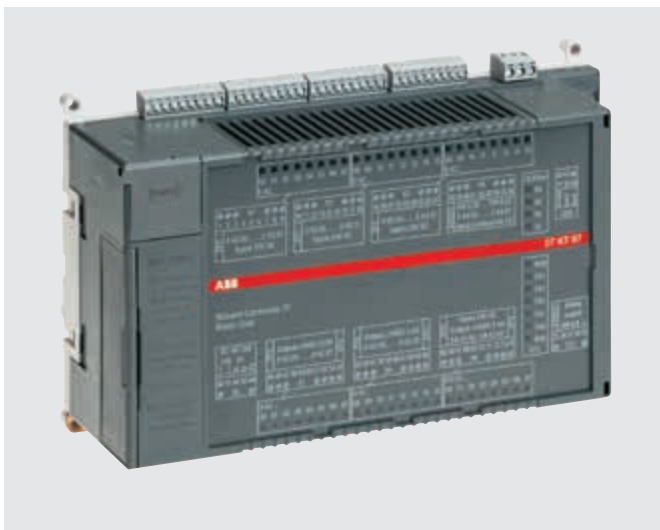

AC31 adapter for spare parts

AC500 life cycle management

Under certain conditions, the AC31 adapter I/O modules may be used as spare parts for existing applications where the previous AC31 modules were installed. The AC31 adapter modules can normally replace old modules without any changes in the configuration or application.

The new module is configured with DIP switches, the old one removed, the new one installed and the application started again.

The modules have the same footprint, cabling position and channel assignment. The AC31 adapter module supports most of the previous functionalities of the old module. There are only

a few exceptions and minor differences that are listed below:

- The AC31 adapter I/O modules can only be used, supported and tested with ABB AC31 master devices and cannot run with third party controllers.
- The AC31 adapter modules are based on standard AC500 I/O modules and on a specific electronic base, the modules cannot be purchased separately and are always delivered as complete devices. The pluggable electronic module cannot be replaced separately without the base.

For special applications, further details or specific questions regarding compatibility, please contact your local sales organization.



AC31 adapter

AC500 life cycle management

Replacement table and compatibility information

Previous AC31 I/O module			New AC31 adapter module			Difference in feature / feature not supported
PN	Type designation	I/O combination	PN	Type designation	I/O combination supported	
GJR5251400R0202	07DC91	16DI/8DO/8DC	1SAP800300R0010	07DC91-AD	16DI/16DC	No local test button, compatible with basic diagnostics only.
GJR5252200R0202	07DC92	32DC	1SAP800500R0010	07DC92-AD	32DC	Same electrical potential for all channels (no group isolation), input current only max. 2 mA per channel, max. 8 A current sum for all outputs, no local test button, compatible with basic diagnostics only.
GJR5251600R0202	07AI91	8 AI, U/I PT100 and thermocouple	1SAP800200R0010	07AI91-AD	8AI	Standard analog voltage or current inputs, PT100/1000 only up to 3-wire connection, no thermocouple support, linear approximation always on, no test button, only standard as in 07AI91.
GJR5252300R0101	07AC91	16 AC or 8 AI/8 AO	1SAP800000R0010	07AC91-AD	16AO	No 16 AI inputs but only 16 AO in 16 AC configuration, no local test button, compatible with basic diagnostics only.
			1SAP800100R0010	07AC91-AD2	8AI/8AO	No local test button, compatible with basic diagnostics only.

New AC31 adapter PLC module

PN	Type designation	Communication	I/O combination supported	Difference in feature / feature not supported
1SAP801400R0060	07KT98-ARC-AD	ARCNET	16DI/16DO/16DC/8AI/4AO	Programming using Automation Builder software means that old AC31 user applications must be re-written and direct import of the old program is not possible. Libraries are different and not all features are supported. Only PROFIBUS DP Master is supported. Same footprint and I/O channel position as old AC31 07KT98 CPU.
1SAP801100R0062	07KT98-ARC-DP-AD	ARCNET, PROFIBUS DP Master	16DI/16DO/16DC/8AI/4AO	
1SAP801200R0062	07KT98-ARC-ETH-AD	ARCNET, Ethernet TCP/IP	16DI/16DO/16DC/8AI/4AO	
1SAP801300R0072	07KT98-ETH-DP-AD	Ethernet TCP/IP, PROFIBUS DP Master	16DI/16DO/16DC/8AI/4AO	
1SAP801500R0062	07KT98-ARC-ETH-DP-AD	ARCNET, Ethernet TCP/IP, PROFIBUS DP Master	16DI/16DO/16DC/8AI/4AO	

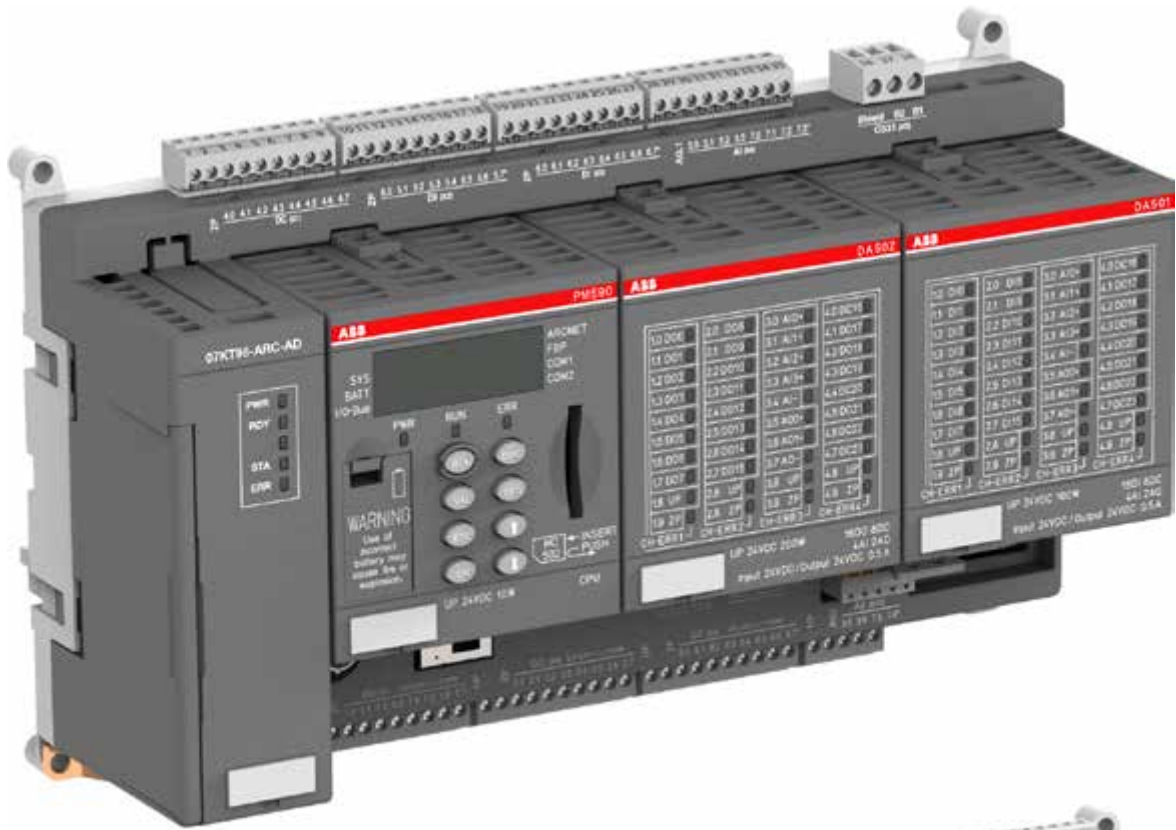

01 07KT98-ARC-AD



02 DC501-CS31-AD



03 07AC91-AD

Additional information Services

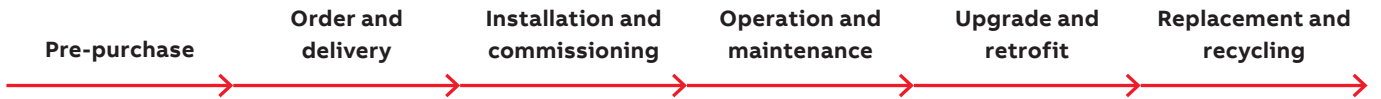

Services offered for ABB's automation products span the entire asset lifetime, from the moment a customer makes the first inquiry to disposal and recycling of the product. Throughout the life cycle of an asset, ABB provides training, technical support and customized contracts, supported by one of the world's most extensive global sales and service networks.

Pre-purchase

ABB provides a range of services and support guiding the customers to the ideal products for their applications.

Order and delivery

Orders can be placed at any ABB office or channel partner. In some countries, ABB also offers an on-line order tracking system. ABB's sales and service network ensures timely deliveries and also offers express delivery.

Installation and commissioning

While many customers have the resources to perform installation and commissioning on their own, ABB and its channel partners also offer professional installation and start-up services if requested.

Operation and maintenance

From maintenance assessments, preventive maintenance, reconditioning of spare parts and repairs on-site or in workshops, ABB has all the options covered to keep their customers' processes operational.

Upgrade and retrofit

Frequently, ABB products can often be upgraded to the latest software or hardware in order to improve the performance of the application. Existing processes can be economically modernized by retrofitting with up-to-date technology.

Replacement and recycling

ABB provides assistance in the best replacement of products while ensuring disposal and recycling observing the local environmental regulations.

Additional information

Life cycle management



Product life cycle management model

ABB has developed a PLC life cycle management model aimed at providing proactive services for maximizing availability and performance. This model not only provides optimum support to end-users but also a smooth transition to a new product when the PLC has come to the end of its lifetime.

The life cycle management model divides a product's life cycle into four phases: active, classic, limited and obsolete. Each phase has different implications for the end-user in terms of services provided.

Active phase

The active phase starts when the product is launched. In the active phase the end user benefits from different warranty options and other services such as training and technical support. Complete life cycle services from spare parts and maintenance are also provided. The active phase ends when the volume production of a particular PLC ceases and ABB issues an announcement of the life cycle phase change.

Classic phase

ABB PLC users continue to benefit from complete life cycle services throughout the classic phase. The classic phase is closely aligned with ABB's research and development work to provide continuing support for its PLC products while developing future generations. In the classic phase new hardware and software development may be required to provide the maintenance techniques and upgrades needed to guarantee that the PLC continues to operate at its peak performance. Migration to a new PLC product is recommended before the product has entered the limited phase.

Limited phase

In the limited phase the product development has come to its end. Spare parts are available as long as components and materials can be obtained. Towards the end of the limited phase, services gradually become obsolete. In addition to the annual life cycle status reviews, ABB issues a life cycle phase change announcement, half a year prior the product becoming obsolete. This is the last opportunity to transfer to new technology before product services end.

Obsolete phase

The product is transferred to the obsolete phase when it is no longer possible to provide services at reasonable cost or when ABB can no longer support the product technically or the old technology is not available.

Benefits of life cycle management

PLC life cycle management maximizes the value of the equipment and its maintenance investments by:

- ensuring spare parts and ABB competence availability throughout the lifetime
- enabling efficient product support and maintenance for improved reliability
- adding functionality to the initial product by upgrading or retrofitting
- providing a smooth transition to new technology at the end of the product lifetime.

For more information, please see www.abb.com/plc or contact your local sales organization.

Additional information

Automation Builder product life cycle plan

Product life cycle

ABB is committed to supporting our customers' installed system base. We want to optimize our customers' system investment and provide our customers with the confidence that there is a well-defined support and a path forward for existing ABB systems. ABB's product life cycle policy provides advanced notification of planned changes in product availability and support.

This chapter shall not be understood as legally binding. Users are recommended to keep informed about updates by periodically checking relevant life cycle information.

Predictive releases – continuous delivery

ABB continuously maintains and improves its software products. As part of this effort, we develop and release major versions, minor versions and service releases.

Major and minor releases focus on new features whereas service releases deliver corrections and quality improvements. A new service release supersedes and replaces existing service releases within the same major/minor release. All releases contain corrections to issues either identified in ABB test labs or reported by our customers.

Release Type	Designation example	Purpose and frequency
Major Release	1.x, 2.x	Deliver new features extending Automation Builder scope
Minor Releases	1.1.x, 1.2.x	Deliver new features within current Automation Builder scope
Service Releases	1.2.1, 1.2.2	Deliver corrections, improvements and updates of existing components

ABB aims for continuous, consistent and coordinated delivery of engineering tool versions and device firmware versions. It is recommended to always use the latest release of Automation Builder.

Version profiles – compatibility with installed base

ABB aims at maximizing availability and performance of the installed base. In this effort we

follow these two principles: The engineering tool shall provide the latest features in best quality. The engineering tool and installed base shall always be compatible.

To meet these requirements Automation Builder introduced version profiles. A version profile contains all Automation Builder software components as released in the latest service release of a specific major/minor version, including respective device firmware versions.

Version profiles can be installed with every release of Automation Builder. Multiple version profiles can be installed in parallel. Each version profile goes through all product life cycle phases. Life cycle statements apply to each version profile and corresponding licenses. The availability of a version profile depends on the life cycle phase it is currently in.

All this allows our users to install the latest version of Automation Builder and keep compatibility with the installed base. Updates of the runtime system are avoided. The latest Automation Builder release always contains the best quality for all profiles. Corrections are distributed via releases and not via hard to track patches.

Automation Builder life cycle management model

The Automation Builder life cycle management model aims to provide service for maximizing availability and performance, support to end-users and a smooth transition to new product versions when the service life of the current product ends. The model divides a product's life cycle into four phases: active, classic, limited and obsolete. Each phase has different implications for the end-user in terms of software and license availability, services and support provided.

Active	The software product with complete life cycle services is available.
Classic	The software product with complete life cycle services is available for system extensions and spare part engineering.
Limited	The software product is available without maintenance and further corrections. Migration to a newer version is recommended.
Obsolete	Migration to a newer version is recommended.

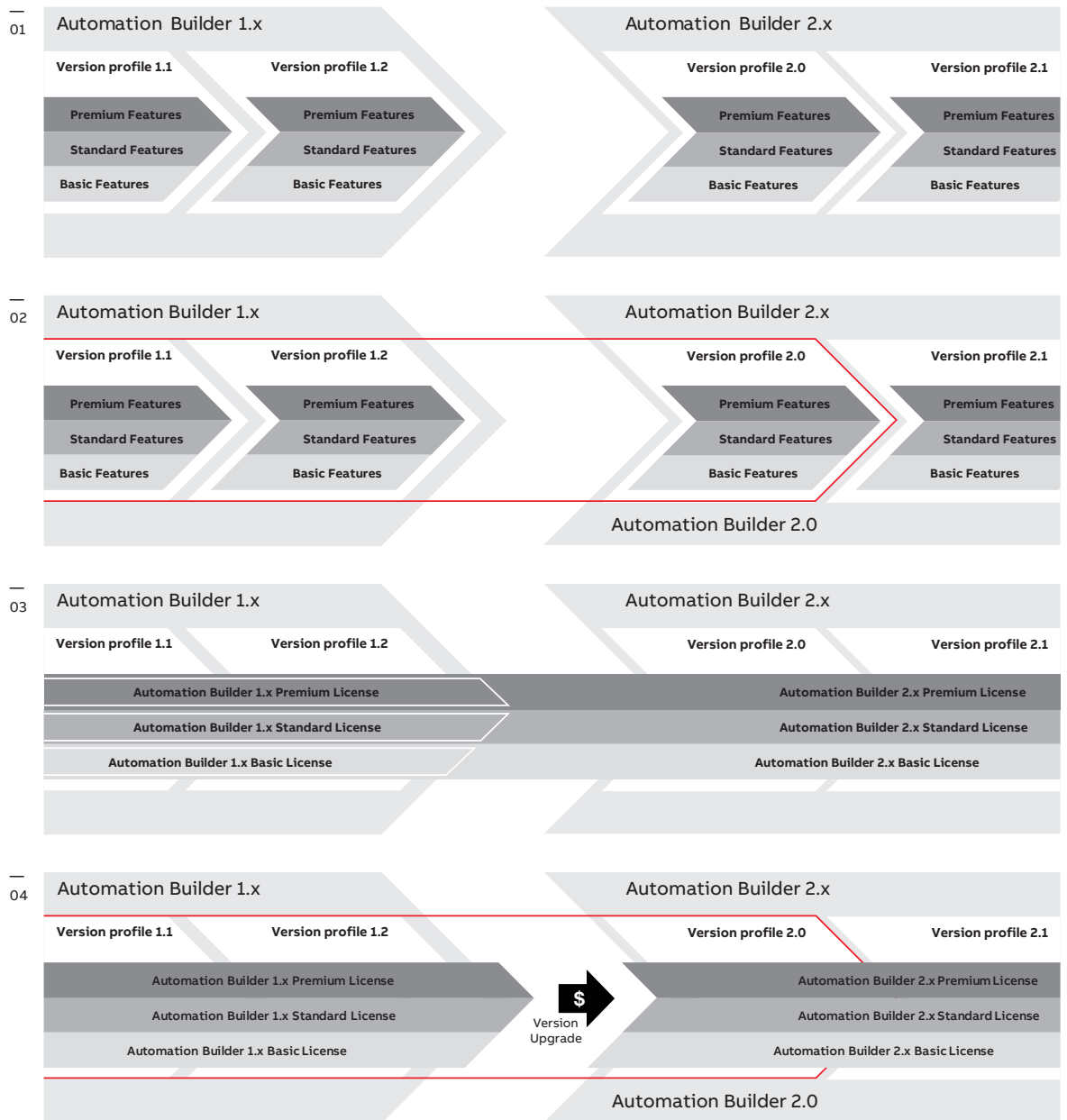

Version profiles and licenses

01 – Major versions come in several minor versions, e.g. Automation Builder 1.x comes as Automation Builder 1.1 and 1.2. Version profiles cover different sets of features, e.g. basic, standard and premium feature sets.

02 – An Automation Builder release contains multiple version profiles, each corresponding to a released minor version. E.g. release Automation Builder 2.0 contains version profile 2.0, 1.2, 1.1 and more.

03 – To use a feature a license is required. The license defines which feature set can be used, e.g. a premium license enables you to use the premium feature set. A license corresponds to a major version of Automation Builder, e.g.

Automation Builder 2.x Premium license enables to use Premium features in all 2.x minor versions and in all previous versions.

04 – There are two different cases where you have to purchase a new Automation Builder license:

- Edition upgrade: Need for a higher value license option within the same major version of Automation Builder, e.g. Automation Builder 2.x Premium instead of Standard.
- Version upgrade: Upgrade from one major Automation Builder version to another, e.g. Automation Builder 1.x to 2.x. – Note: Licenses for Automation Builder 1.x and Automation Builder 2.x can be used in parallel in order to support different version profiles.

Additional information

Automation Builder product life cycle plan

Life cycle phases

Active

A newly released version profile of Automation Builder starts in life cycle phase Active. During the Active phase the version profile is available with complete life cycle services.

This means the version profile is available via Automation Builder installation manager from abb.com and will receive ABB's normal product maintenance including enhancements and corrections, and third party software updates.

The version is the base for current sales and active price list. Licenses can be purchased. Support and training is provided.

Classic

With release of the next major/minor version the predecesing version profile is going into life cycle phase Classic. During the Classic phase, the version profile with complete life cycle services is available for system extensions and spare part engineering.

Classic version profiles are available via Automation Builder installation manager from abb.com and will receive corrections only for critical issues. Classic version profiles are typically available as released in the latest respective service release (and additional corrections). New 3rd party products (e.g. OS) are not supported anymore.

Licenses can be purchased. Training is not available anymore. Support is provided.

Limited

During the Limited phase, the version profile is available without maintenance and further corrections. Migration to a newer version is recommended.

This means it is no longer available from Automation Builder installation manager from abb.com, but could be obtained as offline installations via support. Corrections might be available upon request as billable service. New 3rd party products (e.g. OS) are not supported anymore.

Licenses can be purchased. Training is not available anymore. Support is provided.

Obsolete

When entering the Obsolete phase, the version profile is not supported anymore. Migration to a newer version is strongly recommended.

This means it is not available anymore for installation. It will not receive corrections anymore.

Licenses can be purchased. Training is not available anymore. Support is not available anymore.

Additional information

Generic composition of type designation



The identification number starts with 5 for the AC500 PLC platform or 6 for the CP600 HMI platform.

Example: AC500-eCo central processing unit

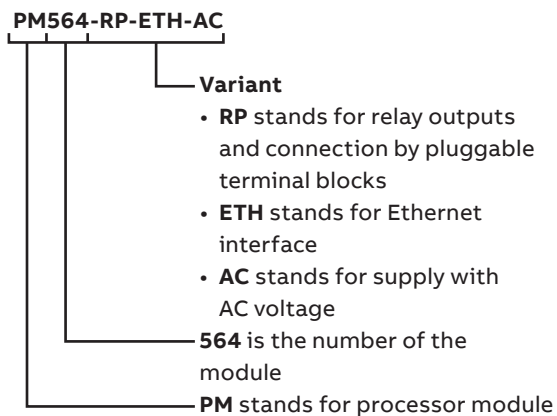

Prefix of module types

Letters	Meaning
AI	Analog input module
AO	Analog output module
AX	Analog input/output module (X stands for mixed input/output)
CD	Counter module
CI	Communication interface module for remote I/O station
CM	Communication module attached to the CPU
CP	Control panel (HMI)
DA	Mixed analog/digital input/output module
DC	Digital I/O module with channels configurable as inputs or outputs
DI	Digital input module
DM	PLC engineering software Automation Builder or add-ons
DO	Digital output module
DX	Digital input/output module (X stands for mixed input/output)
FM	Function module
MC	Memory card or memory card adapter
PB	Panel Builder engineering software for HMI
PM	PLC CPU module
PS	Application-specific function block libraries
SM	Safety CPU module
TA	Accessories and training cases
TB	Terminal base for CPU modules
TF	Terminal base for CPU with function modules
TK	Communication cable
TU	Terminal unit for I/O modules

Additional information

Certifications

Symbols and legends: ● Standard product certified: product label wears approval mark when mandatory
 ○ Submitted (roadmap available upon request)
 ○ Submission planned (roadmap available upon request)
 – Submission not planned or not applicable for product

Name	Conformité Européenne	SJ/T 11363-2006 (China RoHS)	Regulatory Compliance Mark (RCM)	Eurasian Conformity	Korea Certification	Underwriter Laboratories	American Bureau of Shipping	Bureau Veritas	DNV-GL	Lloyds Register	RINA	Russian Maritime Register of Shipping	Korean Register of Shipping			
Logo / Certification Mark																
Certificate	Declaration of Conformity LVD / EMC	Declaration of Conformity RoHS	Declaration of Conformity	Declaration of Conformity	Declaration of Conformity	Declaration of Conformity	cULus Ordinary Locations	cULus Hazardous Locations	Design Assessment	Type Approval	Type Approval	EU RO Mutual Recognition	Type Approval	Type Approval	Type Approval	Type Approval
AC522	●	●	●	●	○	○	●	●	●	●	○	●	●	●	○	
AI523	●	●	●	●	●	●	●	●	●	●	○	●	●	●	○	
AI523-XC	●	●	●	●	●	●	●	●	●	●	○	●	●	●	○	
AI531	●	●	●	●	●	●	●	●	●	●	○	●	●	○	○	
AI531-XC	●	●	●	●	●	●	●	●	●	●	○	●	●	○	○	
AI561	●	●	●	●	●	●	●	●	●	●	●	●	●	●	●	
AI562	●	●	●	●	●	●	●	●	●	●	●	●	●	●	●	
AI563	●	●	●	●	●	●	●	●	●	●	○	●	●	●	●	
AI581-S	●	●	●	●	●	●	●	●	●	●	○	●	●	●	○	
AI581-S-XC	●	●	●	●	●	○	●	●	●	●	○	●	●	●	○	
AO523	●	●	●	●	●	●	●	●	●	●	○	●	●	●	○	
AO523-XC	●	●	●	●	●	●	●	●	●	●	○	●	●	●	○	
AO561	●	●	●	●	●	●	●	●	●	●	●	●	●	●	●	
AX521	●	●	●	●	●	●	●	●	●	●	-	●	●	●	○	
AX521-XC	●	●	●	●	●	●	●	●	●	●	○	●	●	●	○	
AX522	●	●	●	●	●	●	●	●	●	●	○	●	●	●	○	
AX522-XC	●	●	●	●	●	●	●	●	●	●	○	●	●	●	○	
AX561	●	●	●	●	●	●	●	●	●	●	●	●	●	●	●	
CD522	●	●	●	●	●	●	●	●	●	●	○	●	●	●	○	
CD522-XC	●	●	●	●	●	●	●	●	●	●	○	●	●	●	○	
CI501-PNIO	●	●	●	●	●	●	●	●	●	●	○	●	●	●	○	
CI501-PNIO-XC	●	●	●	●	●	●	●	●	●	●	○	●	●	●	○	
CI502-PNIO	●	●	●	●	●	●	●	●	●	●	○	●	●	●	○	
CI502-PNIO-XC	●	●	●	●	●	●	●	●	●	●	○	●	●	●	○	
CI504-PNIO	●	●	●	●	●	●	●	●	●	●	○	●	●	●	○	
CI504-PNIO-XC	●	●	●	●	●	●	●	●	●	●	○	●	●	●	○	
CI506-PNIO	●	●	●	●	●	●	●	●	●	●	○	●	●	●	○	
CI506-PNIO-XC	●	●	●	●	●	●	●	●	●	●	○	●	●	●	○	
CI511-ETHCAT	●	●	●	●	●	●	●	●	●	●	○	●	●	●	○	
CI512-ETHCAT	●	●	●	●	●	●	●	●	●	●	○	●	●	●	○	
CI521-MODTCP	●	●	●	●	●	○	●	●	○	●	○	○	○	○	○	
CI521-MODTCP-XC	●	●	●	●	●	○	●	●	○	●	○	○	○	○	○	
CI522-MODTCP	●	●	●	●	●	○	●	●	○	●	○	○	○	○	○	
CI522-MODTCP-XC	●	●	●	●	●	○	●	●	○	●	○	○	○	○	○	
CI541-DP	●	●	●	●	●	●	●	●	●	●	○	●	●	●	○	
CI541-DP-XC	●	●	●	●	●	●	●	●	●	●	○	●	●	●	○	
CI542-DP	●	●	●	●	●	●	●	●	●	●	○	●	●	●	○	
CI542-DP-XC	●	●	●	●	●	●	●	●	●	●	○	●	●	●	○	

- Symbols and legends: ● Standard product certified; product label wears approval mark when mandatory
 ○ Submitted (roadmap available upon request)
 ○ Submission planned (roadmap available upon request)
 – Submission not planned or not applicable for product

Name	Conformité Européenne	SJ/T 11363-2006 (China RoHS)	Regulatory Compliance Mark (RCM)	Eurasian Conformity	Korea Certification	Underwriter Laboratories	American Bureau of Shipping	Bureau Veritas	DNV-GL	Lloyds Register	RINA	Russian Maritime Register of Shipping	Korean Register of Shipping			
Logo / Certification Mark																
Certificate	Declaration of Conformity LVD / EMC	Declaration of Conformity RoHS	Declaration of Conformity	Declaration of Conformity	Declaration of Conformity	Declaration of Conformity	cULus Ordinary Locations	cULus Hazardous Locations	Design Assessment	Type Approval	Type Approval	EURO Mutual Recognition	Type Approval	Type Approval	Type Approval	Type Approval
CI581-CN	●	●	●	●	●	●	●	●	●	●	○	●	●	●	○	
CI581-CN-XC	●	●	●	●	●	●	●	●	●	●	○	●	●	●	○	
CI582-CN	●	●	●	●	●	●	●	●	●	●	○	●	●	●	○	
CI582-CN-XC	●	●	●	●	●	●	●	●	●	●	○	●	●	●	○	
CI590-CS31-HA	●	●	●	●	●	●	●	●	●	●	○	●	●	●	○	
CI590-CS31-HA-XC	●	●	●	●	●	●	●	●	●	●	○	●	●	●	○	
CI592-CS31	●	●	●	●	●	●	●	●	●	●	○	●	●	●	○	
CI592-CS31-XC	●	●	●	●	●	●	●	●	●	●	○	●	●	●	○	
CM572-DP	●	●	●	●	●	●	●	●	●	●	○	●	●	●	○	
CM572-DP-XC	●	●	●	●	●	●	●	●	●	●	○	●	●	●	○	
CM574-RCOM	●	●	●	●	●	●	●	●	●	●	○	●	●	●	○	
CM574-RS	●	●	●	●	●	●	●	●	●	●	○	●	●	●	○	
CM578-CN	●	●	●	●	●	●	●	●	●	●	○	●	●	●	○	
CM578-CN-XC	●	●	●	●	●	●	●	●	●	●	○	●	●	●	○	
CM579-ETHCAT	●	●	●	○	●	●	●	●	●	●	○	●	●	●	○	
CM579-PNIO	●	●	●	●	●	●	●	●	●	●	○	●	●	●	○	
CM579-PNIO-XC	●	●	●	●	●	●	●	●	●	●	○	●	●	●	○	
CM582-DP	●	●	○	○	●	○	●	●	○	○	○	○	○	○	○	
CM582-DP-XC	●	●	○	○	●	○	●	●	○	○	○	○	○	○	○	
CM588-CN	●	●	●	●	●	●	●	●	●	●	○	●	●	●	○	
CM588-CN-XC	●	●	●	●	●	●	●	●	●	●	○	●	●	●	○	
CM589-PNIO	●	●	○	○	●	-	●	●	○	●	○	●	●	○	○	
CM589-PNIO-4	●	●	○	○	●	-	●	●	○	●	○	●	●	○	○	
CM589-PNIO-4-XC	●	●	○	○	●	-	●	●	○	●	○	●	●	○	○	
CM589-PNIO-XC	●	●	○	○	●	-	●	●	○	●	○	●	●	○	○	
CM592-DP	●	●	○	○	●	-	●	●	○	●	○	●	●	○	○	
CM592-DP-XC	●	●	○	○	●	-	●	●	○	●	○	●	●	○	○	
CM597-ETH	●	●	●	●	●	-	●	●	○	●	○	●	●	○	○	
CM597-ETH-XC	●	●	●	●	●	-	●	●	○	●	○	●	●	○	○	
CM598-CN	●	●	○	○	●	-	●	●	○	●	○	●	●	○	○	
CM598-CN-XC	●	●	○	○	●	-	●	●	○	●	○	●	●	○	○	
CP604	●	●	○	○	●	-	●	-	-	●	●	-	-	-	○	
CP604-B	●	●	○	○	●	-	●	-	-	●	●	-	-	-	○	
CP607	●	●	○	○	●	-	●	-	-	●	●	-	-	-	○	
CP607-B	●	●	○	○	●	-	●	-	-	●	●	-	-	-	○	
CP610	●	●	○	○	●	-	●	-	-	●	●	-	-	-	○	
CP610-B	●	●	○	○	●	-	●	-	-	●	●	-	-	-	○	
CP620	●	●	●	●	●	●	●	●	-	●	●	-	-	-	-	
CP620-WEB	●	●	●	●	●	●	●	●	-	●	●	-	-	-	-	
CP630	●	●	●	●	●	●	●	●	-	●	●	-	-	-	-	
CP630-WEB	●	●	●	●	●	●	●	●	-	●	●	-	-	-	-	
CP635	●	●	●	●	●	●	●	●	-	●	●	-	-	-	-	
CP635-B	●	●	○	○	●	○	●	●	-	●	●	-	-	-	-	
CP635-FB	●	●	○	○	●	○	●	-	-	●	●	-	-	-	-	
CP635-FW	●	●	○	○	●	○	●	-	-	●	●	-	-	-	-	
CP635-WEB	●	●	○	○	●	○	●	-	-	●	●	-	-	-	-	

Additional information

Certifications

Symbols and legends: ● Standard product certified: product label wears approval mark when mandatory
 ○ Submitted (roadmap available upon request)
 ○ Submission planned (roadmap available upon request)
 – Submission not planned or not applicable for product

Name	Conformité Européenne	SJ/T 11363-2006 (China RoHS)	Regulatory Compliance Mark (RCM)	Eurasian Conformity	Korea Certification	Underwriter Laboratories	American Bureau of Shipping	Bureau Veritas	DNV-GL	Lloyds Register	RINA	Russian Maritime Register of Shipping	Korean Register of Shipping			
Logo / Certification Mark																
Certificate	Declaration of Conformity LVD / EMC	Declaration of Conformity RoHS	Declaration of Conformity	Declaration of Conformity	Declaration of Conformity	Declaration of Conformity	cULus Ordinary Locations	cULus Hazardous Locations	Design Assessment	Type Approval	Type Approval	EU RO Mutual Recognition	Type Approval	Type Approval	Type Approval	Type Approval
CP6407	○	○	○	○	○	○	○	○	-	-	○	○	-	-	-	-
CP6410	○	○	○	○	○	○	○	○	-	-	○	○	-	-	-	-
CP6415	○	○	○	○	○	○	○	○	-	-	○	○	-	-	-	-
CP651	●	●	●	○	●	○	●	●	-	-	●	●	-	-	-	-
CP651-WEB	●	●	●	○	●	○	●	●	-	-	●	●	-	-	-	-
CP6605	●	●	○	○	●	○	●	●	-	-	●	●	-	-	-	○
CP6607	●	●	○	○	●	○	●	●	-	-	●	●	-	-	-	○
CP661	●	●	●	○	●	○	●	●	-	-	●	-	-	-	-	-
CP6610	●	●	○	○	●	○	●	●	-	-	●	●	-	-	-	○
CP6615	●	●	○	○	●	○	●	●	-	-	●	●	-	-	-	○
CP661-WEB	●	●	●	○	●	○	●	●	-	-	●	-	-	-	-	-
CP6621	●	●	○	○	●	○	●	●	-	-	●	●	-	-	-	○
CP665	●	●	●	○	●	○	●	●	-	-	●	-	-	-	-	-
CP665-WEB	●	●	●	○	●	○	●	●	-	-	●	-	-	-	-	-
CP676	●	●	●	○	●	○	●	●	-	-	●	-	-	-	-	-
CP676-WEB	●	●	●	○	●	○	●	●	-	-	●	-	-	-	-	-
DA501	●	●	●	●	●	●	●	●	●	●	●	○	●	●	●	○
DA501-XC	●	●	●	●	●	●	●	●	●	●	●	○	●	●	●	○
DA502	●	●	●	○	●	○	●	●	●	○	○	○	●	●	○	○
DA502-XC	●	●	●	○	●	○	●	●	●	○	○	○	●	●	○	○
DC522	●	●	●	●	●	●	●	●	●	●	●	○	●	●	●	○
DC522-XC	●	●	●	●	●	●	●	●	●	●	●	○	●	●	●	○
DC523	●	●	●	●	●	●	●	●	●	●	●	○	●	●	●	○
DC523-XC	●	●	●	●	●	●	●	●	●	●	●	○	●	●	●	○
DC532	●	●	●	●	●	●	●	●	●	●	●	○	●	●	●	○
DC532-XC	●	●	●	●	●	●	●	●	●	●	●	○	●	●	●	○
DC541-CM	●	●	●	●	●	●	●	●	●	●	●	○	●	●	●	○
DC541-CM-XC	●	●	●	●	●	●	●	●	●	●	●	○	●	●	●	○
DC551-CS31	●	●	●	●	●	●	●	●	●	●	●	○	●	●	●	○
DC551-CS31-XC	●	●	●	●	●	●	●	●	●	●	●	○	●	●	●	○
DC561	●	●	●	●	●	●	●	●	●	●	●	●	●	●	●	●
DC562	●	●	●	●	●	○	●	●	●	○	●	●	●	●	○	●
DI524	●	●	●	●	●	●	●	●	●	●	●	○	●	●	●	○
DI524-XC	●	●	●	●	●	●	●	●	●	●	●	○	●	●	●	○
DI561	●	●	●	●	●	●	●	●	●	●	●	●	●	●	●	●
DI562	●	●	●	●	●	●	●	●	●	●	●	●	●	●	●	●
DI571	●	●	●	●	●	●	●	●	●	●	●	●	●	●	●	●
DI572	●	●	●	●	●	○	●	●	●	○	●	●	●	●	○	●

- Symbols and legends: ● Standard product certified; product label wears approval mark when mandatory
 ○ Submitted (roadmap available upon request)
 ○ Submission planned (roadmap available upon request)
 – Submission not planned or not applicable for product

Name	Conformité Européenne	SJ/T 11363-2006 (China RoHS)	Regulatory Compliance Mark (RCM)	Eurasian Conformity	Korea Certification	Underwriter Laboratories	American Bureau of Shipping	Bureau Veritas	DNV-GL	Lloyds Register	RINA	Russian Maritime Register of Shipping	Korean Register of Shipping			
Logo / Certification Mark																
Certificate	Declaration of Conformity LVD / EMC	Declaration of Conformity RoHS	Declaration of Conformity	Declaration of Conformity	Declaration of Conformity	Declaration of Conformity	cULus Ordinary Locations	cULus Hazardous Locations	Design Assessment	Type Approval	Type Approval	EURO Mutual Recognition	Type Approval	Type Approval	Type Approval	Type Approval
DI581-S	●	●	●	●	●	●	●	●	●	●	○	●	●	●	○	
DI581-S-XC	●	●	●	●	●	○	●	●	●	●	○	●	●	●	○	
DO524	●	●	●	○	●	○	●	●	●	○	●	○	●	○	○	
DO524-XC	●	●	●	○	●	○	●	●	●	○	●	○	●	○	○	
DO526	●	●	●	○	●	○	●	●	●	●	○	●	●	○	○	
DO526-XC	●	●	○	○	●	○	●	●	●	●	○	●	●	○	○	
DO561	●	●	●	●	●	●	●	●	●	●	●	●	●	●	●	
DO562	●	●	●	●	●	○	●	●	●	○	●	●	●	○	●	
DO571	●	●	○	●	●	●	●	●	●	●	●	●	●	●	●	
DO572	●	●	●	●	●	●	●	●	●	●	●	●	●	●	●	
DO573	●	●	●	●	●	○	●	●	●	○	●	●	●	○	●	
DX522	●	●	●	●	●	●	●	●	●	●	○	●	●	●	○	
DX522-XC	●	●	●	●	●	●	●	●	●	●	○	●	●	●	○	
DX531	●	●	●	●	●	●	●	●	●	●	○	●	●	●	○	
DX561	●	●	●	●	●	●	●	●	●	●	●	●	●	●	●	
DX571	●	●	●	●	●	●	●	●	●	●	●	●	●	●	●	
DX581-S	●	●	●	●	●	●	●	●	●	●	○	●	●	●	○	
DX581-S-XC	●	●	●	●	●	○	●	●	●	●	○	●	●	●	○	
FM502-CMS	●	●	●	○	●	●	●	●	●	○	●	○	●	○	○	
FM502-CMS-XC	●	●	●	○	●	●	●	●	●	○	●	○	●	○	○	
FM562	●	●	●	●	●	○	●	●	●	○	●	●	●	○	●	
MC502	●	●	●	○	●	○	●	●	●	●	○	●	●	●	○	
MC503	●	●	●	●	●	●	●	●	●	●	●	●	●	●	●	
PD501-4CH	●	●	●	●	○	●	-	●	●	●	○	●	●	●	○	
PM554-RP	●	●	●	●	●	○	●	●	●	●	●	●	●	●	●	
PM554-RP-AC	●	●	●	●	●	○	●	●	●	●	●	●	●	●	●	
PM554-TP	●	●	●	●	●	○	●	●	●	●	●	●	●	●	●	
PM554-TP-ETH	●	●	●	●	●	○	●	●	●	●	●	●	●	●	●	
PM556-TP-ETH	●	●	●	●	●	○	●	●	●	●	●	●	●	●	●	
PM5630-2ETH	●	●	○	○	●	○	●	●	●	●	○	●	●	○	○	
PM5630-2ETH-XC	●	●	○	○	●	○	●	●	●	●	○	●	●	○	○	
PM564-RP	●	●	●	●	●	○	●	●	●	●	●	●	●	●	●	
PM564-RP-AC	●	●	●	●	●	○	●	●	●	●	●	●	●	●	●	
PM564-RP-ETH	●	●	●	●	●	○	●	●	●	●	●	●	●	●	●	
PM564-RP-ETH-AC	●	●	●	●	●	○	●	●	●	●	●	●	●	●	●	
PM564-TP	●	●	●	●	●	○	●	●	●	●	●	●	●	●	●	
PM564-TP-ETH	●	●	●	●	●	○	●	●	●	●	●	●	●	●	●	
PM5650-2ETH	●	●	●	○	●	○	●	●	●	●	○	●	●	○	○	
PM5650-2ETH-XC	●	●	○	○	●	○	●	●	●	●	○	●	●	○	○	
PM566-TP-ETH	●	●	●	●	●	○	●	●	●	○	●	●	●	○	●	
PM5670-2ETH	●	●	○	○	●	○	●	●	●	●	○	●	●	○	○	
PM5670-2ETH-XC	●	●	○	○	●	○	●	●	●	●	○	●	●	○	○	
PM5675-2ETH	●	●	○	○	●	○	●	●	●	●	○	●	●	○	○	
PM5675-2ETH-XC	●	●	○	○	●	○	●	●	●	●	○	●	●	○	○	
PM572	●	●	●	●	●	●	●	●	●	●	○	●	●	●	○	
PM573-ETH	●	●	●	●	●	●	●	●	●	●	○	●	●	●	○	

Additional information

Certifications

Symbols and legends: ● Standard product certified: product label wears approval mark when mandatory
 ○ Submitted (roadmap available upon request)
 ○ Submission planned (roadmap available upon request)
 – Submission not planned or not applicable for product

Name	Conformité Européenne	SJ/T 11363-2006 (China RoHS)	Regulatory Compliance Mark (RCM)	Eurasian Conformity	Korea Certification	Underwriter Laboratories	American Bureau of Shipping	Bureau Veritas	DNV-GL	Lloyds Register	RINA	Russian Maritime Register of Shipping	Korean Register of Shipping			
Logo / Certification Mark																
Certificate	Declaration of Conformity LVD / EMC	Declaration of Conformity RoHS	Declaration of Conformity	Declaration of Conformity	Declaration of Conformity	Declaration of Conformity	cULus Ordinary Locations	cULus Hazardous Locations	Design Assessment	Type Approval	Type Approval	EU RO Mutual Recognition	Type Approval	Type Approval	Type Approval	Type Approval
PM573-ETH-XC	●	●	●	●	●	●	●	●	●	●	○	●	●	●	○	
PM582	●	●	●	●	●	●	●	●	●	●	○	●	●	●	○	
PM582-XC	●	●	●	●	●	●	●	●	●	●	○	●	●	●	○	
PM583-ETH	●	●	●	●	●	●	●	●	●	●	○	●	●	●	○	
PM583-ETH-XC	●	●	●	●	●	●	●	●	●	●	○	●	●	●	○	
PM585-ETH	●	●	○	○	●	○	●	○	●	○	○	○	○	○	○	
PM590-ARCNET	●	●	●	●	●	●	●	●	●	●	○	●	●	●	○	
PM590-ETH	●	●	●	●	●	●	●	●	●	●	○	●	●	●	○	
PM591-2ETH	●	●	●	●	●	○	●	-	●	○	●	○	●	●	○	
PM591-ETH	●	●	●	●	●	●	●	●	●	●	○	●	●	●	○	
PM591-ETH-XC	●	●	●	●	●	●	●	●	●	●	○	●	●	●	○	
PM592-ETH	●	●	●	●	●	●	●	●	●	●	○	●	●	●	○	
PM592-ETH-XC	●	●	●	●	●	●	●	●	●	●	○	●	●	●	○	
PM595-4ETH-F	●	●	●	○	●	○	●	●	●	○	●	○	●	●	○	
PM595-4ETH-M-XC	●	●	●	○	●	○	●	●	●	○	●	○	●	●	○	
SM560-S	●	●	●	●	●	●	●	●	●	●	○	●	●	●	○	
SM560-S-FD-1	●	●	●	○	●	○	●	●	●	○	○	○	○	○	○	
SM560-S-FD-1-XC	●	●	●	○	●	○	●	●	●	○	○	○	○	○	○	
SM560-S-FD-4	●	●	●	○	●	○	●	●	●	○	○	○	○	○	○	
SM560-S-FD-4-XC	●	●	●	○	●	○	●	●	●	○	○	○	○	○	○	
SM560-S-XC	●	●	●	●	●	○	●	●	●	●	○	●	●	●	○	
TA521	-	-	●	-	●	-	●	-	●	○	●	○	-	●	○	
TA523	●	●	●	-	-	-	●	-	●	-	-	-	●	●	-	
TA524	●	●	○	-	●	-	●	-	●	●	○	-	●	●	○	
TA525	-	-	●	-	-	-	●	-	●	-	-	-	●	●	-	
TA526	●	●	●	-	-	-	●	-	●	○	●	○	-	●	○	
TA527	●	●	●	-	●	-	-	-	-	-	-	-	-	-	-	
TA528	●	●	●	-	●	-	-	-	-	-	-	-	-	-	-	
TA532	●	●	○	-	●	-	-	-	-	-	-	-	-	-	-	
TA533	●	●	○	-	●	-	-	-	-	-	-	-	-	-	-	
TA534	●	●	○	-	●	-	-	-	-	-	-	-	-	-	-	
TA535	●	●	●	-	-	-	-	-	-	-	-	-	-	-	-	
TA536	●	●	○	-	●	-	-	-	-	-	-	-	-	-	-	
TA540	●	●	●	-	-	-	-	-	-	-	-	-	-	-	-	
TA541	-	-	●	-	●	-	-	-	-	-	-	-	-	-	-	
TA543	●	●	●	-	-	-	-	-	-	-	-	-	-	-	-	
TA561-RTC	●	●	●	●	●	●	●	●	●	●	●	●	●	●	●	
TA562-RS	●	●	●	●	●	●	●	●	●	●	●	●	●	●	●	

- Symbols and legends:
- Standard product certified; product label wears approval mark when mandatory
 - Submitted (roadmap available upon request)
 - Submission planned (roadmap available upon request)
 - Submission not planned or not applicable for product

Name	Conformité Européenne	SJ/T 11363-2006 (China RoHS)	Regulatory Compliance Mark (RCM)	Eurasian Conformity	Korea Certification	Underwriter Laboratories	American Bureau of Shipping	Bureau Veritas	DNV-GL	Lloyds Register	RINA	Russian Maritime Register of Shipping	Korean Register of Shipping			
Logo / Certification Mark																
Certificate	Declaration of Conformity LVD / EMC	Declaration of Conformity RoHS	Declaration of Conformity	Declaration of Conformity	Declaration of Conformity	Declaration of Conformity	cULus Ordinary Locations	cULus Hazardous Locations	Design Assessment	Type Approval	Type Approval	EURO Mutual Recognition	Type Approval	Type Approval	Type Approval	Type Approval
TA562-RS-RTC	●	●	●	●	●	●	●	●	●	●	●	●	●	●	●	●
TA563-9	●	●	●	-	●	-	-	-	●	●	●	●	●	●	●	●
TA563-11	●	●	●	-	●	-	-	-	●	●	●	●	●	●	●	●
TA564-9	●	●	●	-	●	-	-	-	●	●	●	●	●	●	●	●
TA564-11	●	●	●	-	●	-	-	-	●	●	●	●	●	●	●	●
TA565-9	●	●	●	-	●	-	-	-	●	●	●	●	●	●	●	●
TA565-11	●	●	●	-	●	-	-	-	●	●	●	●	●	●	●	●
TA566	●	●	●	-	-	-	●	●	●	●	●	●	●	●	●	●
TA569-RS-ISO	●	●	○	○	○	○	●	●	○	○	○	○	○	○	○	○
TA570	●	●	●	-	●	-	●	●	-	-	-	-	-	-	-	●
TA571-SIM	●	●	●	●	●	●	-	-	-	-	-	-	-	-	-	●
TB511-ARCNET	●	●	●	●	●	●	●	●	●	●	○	●	●	●	●	-
TB511-ETH	●	●	●	●	●	●	●	●	●	●	○	●	●	●	●	○
TB511-ETH-XC	●	●	●	●	●	●	●	●	●	●	○	●	●	●	●	○
TB521-ARCNET	●	●	●	●	●	●	●	●	●	●	-	●	●	●	●	-
TB521-ETH	●	●	●	●	●	●	●	●	●	●	○	●	●	●	●	○
TB521-ETH-XC	●	●	●	●	●	●	●	●	●	●	○	●	●	●	●	○
TB523-2ETH	●	●	●	●	●	○	●	-	●	○	●	○	●	●	○	○
TB541-ETH	●	●	●	●	●	○	●	●	●	●	○	●	●	●	●	○
TB541-ETH-XC	●	●	●	●	●	○	●	●	●	●	○	●	●	●	●	○
TB5600-2ETH	●	●	○	○	●	○	●	●	●	●	○	●	●	●	○	○
TB5600-2ETH-XC	●	●	-	○	●	○	●	●	●	●	○	○	●	●	○	○
TB5610-2ETH	●	●	○	○	●	○	●	●	●	●	○	●	●	●	○	○
TB5610-2ETH-XC	●	●	-	○	●	○	●	●	●	●	○	○	●	●	○	○
TB5620-2ETH	●	●	○	○	●	○	●	●	●	●	○	●	●	●	○	○
TB5620-2ETH-XC	●	●	-	○	●	○	●	●	●	●	○	○	●	●	○	○
TB5640-2ETH	●	●	○	○	●	○	●	●	○	○	○	○	○	○	○	○
TB5640-2ETH-XC	●	●	-	○	●	○	●	●	○	○	○	○	○	○	○	○
TB5660-2ETH	●	●	-	○	●	○	●	●	○	○	○	○	○	○	○	○
TB5660-2ETH-XC	●	●	-	○	●	○	●	●	○	○	○	○	○	○	○	○
TF501-CMS	●	●	●	○	●	○	●	●	●	○	●	○	●	●	●	○
TF501-CMS-XC	●	●	●	○	●	○	●	●	●	○	●	○	●	●	●	○
TF521-CMS	●	●	●	○	●	○	●	●	●	○	●	○	●	●	●	○
TF521-CMS-XC	●	●	●	○	●	○	●	●	●	○	●	○	●	●	●	○
TK501	●	●	●	-	●	-	●	●	●	-	-	-	●	●	●	●
TK502	●	●	●	-	●	-	●	●	●	-	-	-	●	●	●	●
TK503	●	●	●	●	●	●	●	●	●	●	●	-	●	●	●	●
TK504	●	●	●	●	●	●	●	●	●	●	●	●	●	●	●	●
TK506	●	●	●	●	●	○	●	●	●	●	●	●	●	●	●	●
TU507-ETH	●	●	●	●	●	●	●	●	●	●	○	●	●	●	●	○
TU508-ETH	●	●	●	●	●	●	●	●	●	●	○	●	●	●	●	○
TU508-ETH-XC	●	●	●	●	●	●	●	●	●	●	○	●	●	●	●	○
TU509	●	●	●	●	●	●	●	●	●	●	○	●	●	●	●	○
TU510	●	●	●	●	●	●	●	●	●	●	○	●	●	●	●	○
TU510-XC	●	●	●	●	●	●	●	●	●	●	○	●	●	●	●	○
TU515	●	●	●	●	●	●	●	●	●	●	○	●	●	●	●	○

Additional information

Certifications

Symbols and legends: ● Standard product certified: product label wears approval mark when mandatory
 ○ Submitted (roadmap available upon request)
 ○ Submission planned (roadmap available upon request)
 – Submission not planned or not applicable for product

Name	Conformité Européenne	SJ/T 11363-2006 (China RoHS)	Regulatory Compliance Mark (RCM)	Eurasian Conformity	Korea Certification	Underwriter Laboratories	American Bureau of Shipping	Bureau Veritas	DNV-GL	Lloyds Register	RINA	Russian Maritime Register of Shipping	Korean Register of Shipping			
Logo / Certification Mark																
Certificate	Declaration of Conformity LVD / EMC	Declaration of Conformity RoHS	Declaration of Conformity	Declaration of Conformity	Declaration of Conformity	Declaration of Conformity	cULus Ordinary Locations	cULus Hazardous Locations	Design Assessment	Type Approval	Type Approval	EU RO Mutual Recognition	Type Approval	Type Approval	Type Approval	Type Approval
TU516	●	●	●	●	●	●	●	●	●	●	○	●	●	●	○	
TU516-H	●	●	○	○	●	○	○	○	○	○	○	○	○	○	○	
TU516-H-XC	●	●	○	○	●	○	○	○	○	○	○	○	○	○	○	
TU516-XC	●	●	●	●	●	●	●	●	●	●	○	●	●	●	○	
TU517	●	●	○	●	●	●	●	●	●	●	○	●	●	●	○	
TU518	●	●	○	●	●	●	●	●	●	●	○	●	●	●	○	
TU518-XC	●	●	○	●	●	●	●	●	●	●	○	●	●	●	○	
TU520-ETH	●	●	○	●	●	●	●	●	●	●	○	●	●	●	○	
TU520-ETH-XC	●	●	○	●	●	●	●	●	●	●	○	●	●	●	○	
TU531	●	●	●	●	●	●	●	●	●	●	○	●	●	●	○	
TU532	●	●	●	●	●	●	●	●	●	●	○	●	●	●	○	
TU532-H	●	●	○	○	●	○	○	○	○	○	○	○	○	○	○	
TU532-H-XC	●	●	○	○	●	○	○	○	○	○	○	○	○	○	○	
TU532-XC	●	●	●	●	●	●	●	●	●	●	○	●	●	●	○	
TU541	●	●	○	○	○	●	●	○	●	●	○	●	●	●	○	
TU542	●	●	●	●	●	●	●	●	●	●	○	●	●	●	○	
TU542-H	●	●	○	○	●	○	○	○	○	○	○	○	○	○	○	
TU542-H-XC	●	●	○	○	●	○	○	○	○	○	○	○	○	○	○	
TU542-XC	●	●	○	○	●	○	●	●	●	●	○	●	●	●	○	
TU551-CS31	●	●	●	●	●	●	●	●	●	●	○	●	●	●	○	
TU552-CS31	●	●	●	●	●	●	●	●	●	●	○	●	●	●	○	
TU552-CS31-XC	●	●	●	●	●	●	●	●	●	●	○	●	●	●	○	
TU582-S	●	●	●	●	●	○	●	●	●	●	○	●	●	●	○	
TU582-S-XC	●	●	●	●	●	○	●	●	●	●	○	●	●	●	○	

Index

Order code classification

Order code	Type	Page	Order code	Type	Page	Order code	Type	Page
1SAP110300R0278	TB5600-2ETH	89	1SAP180100R0001	MC502	96	1SAP195600R0101	PS5602-61850	88
1SAP111100R0260	TB511-ARCNET	86	1SAP180100R0001	MC502	144	1SAP195600R0101	PS5602-61850	137
1SAP111100R0270	TB511-ETH	86	1SAP180200R0001	TK501	96	1SAP195800R0101	PS5604-KNX	53
1SAP111300R0278	TB5610-2ETH	89	1SAP180200R0001	TK501	144	1SAP195800R0101	PS5604-KNX	88
1SAP112100R0260	TB521-ARCNET	86	1SAP180200R0101	TK502	96	1SAP195800R0101	PS5604-KNX	137
1SAP112100R0270	TB521-ETH	86	1SAP180200R0101	TK502	144	1SAP210400R0001	TU552-CS31	94
1SAP112300R0277	TB523-2ETH	86	1SAP180300R0001	TA521	96	1SAP210600R0001	TU551-CS31	94
1SAP112300R0278	TB5620-2ETH	89	1SAP180300R0001	TA521	144	1SAP210800R0001	TU510	94
1SAP114100R0270	TB541-ETH	86	1SAP180500R0001	TA523	96	1SAP211000R0001	TU509	94
1SAP114300R0278	TB5640-2ETH	89	1SAP180500R0001	TA523	144	1SAP211200R0001	TU518	94
1SAP116300R0278	TB5660-2ETH	89	1SAP180600R0001	TA524	96	1SAP211400R0001	TU517	94
1SAP117000R0271	TF501-CMS	87	1SAP180600R0001	TA524	144	1SAP212000R0001	TU516	94
1SAP117200R0271	TF521-CMS	87	1SAP180700R0001	TA525	96	1SAP212200R0001	TU515	94
1SAP120600R0001	PM554-TP	66	1SAP180700R0001	TA525	144	1SAP213000R0001	TU541	94
1SAP120600R0071	PM554-TP-ETH	66	1SAP180800R0001	TA526	96	1SAP213200R0001	TU542	94
1SAP120700R0001	PM554-RP	66	1SAP180800R0001	TA526	144	1SAP214000R0001	TU508-ETH	94
1SAP120800R0001	PM554-RP-AC	66	1SAP181100R0001	TA527	96	1SAP214200R0001	TU507-ETH	94
1SAP120900R0001	PM564-TP	66	1SAP181100R0001	TA527	144	1SAP214400R0001	TU520-ETH	94
1SAP120900R0071	PM564-TP-ETH	66	1SAP181200R0001	TA528	96	1SAP215000R0001	TU516-H	93
1SAP121000R0001	PM564-RP	66	1SAP181200R0001	TA528	144	1SAP215100R0001	TU532-H	93
1SAP121000R0071	PM564-RP-ETH	66	1SAP181400R0001	TA561-RTC	68	1SAP215200R0001	TU542-H	93
1SAP121100R0001	PM564-RP-AC	66	1SAP181500R0001	TA562-RS-RTC	68	1SAP217000R0001	TU532	94
1SAP121100R0071	PM564-RP-ETH-AC	66	1SAP182000R0001	TA532	96	1SAP217200R0001	TU531	94
1SAP121200R0071	PM556-TP-ETH	66	1SAP182000R0001	TA532	144	1SAP220500R0001	DC551-CS31	92
1SAP121500R0071	PM566-TP-ETH	66	1SAP182100R0001	TA533	96	1SAP220600R0001	CI501-PNIO	92
1SAP130200R0200	PM572	84	1SAP182100R0001	TA533	144	1SAP220700R0001	CI502-PNIO	92
1SAP130300R0271	PM573-ETH	84	1SAP182200R0001	TA534	96	1SAP220900R0001	CI511-ETHCAT	92
1SAP131000R0278	PM5630-2ETH	88	1SAP182200R0001	TA534	144	1SAP221000R0001	CI512-ETHCAT	92
1SAP140200R0201	PM582	84	1SAP182300R0001	TA535	144	1SAP221100R0001	CI590-CS31-HA	92
1SAP140300R0271	PM583-ETH	84	1SAP182400R0002	TA515-CASE	96	1SAP221200R0001	CI592-CS31	92
1SAP140500R0271	PM585-ETH	84	1SAP182400R0002	TA515-CASE	233	1SAP221300R0001	CI504-PNIO	93
1SAP140500R0379	PM585-MC-KIT	84	1SAP182600R0001	TA540	96	1SAP221500R0001	CI506-PNIO	93
1SAP140500R0379	PM585-MC-KIT	221	1SAP182600R0001	TA540	144	1SAP222100R0001	CI521-MODTCP	92
1SAP141000R0278	PM5650-2ETH	88	1SAP182700R0001	TA541	96	1SAP222200R0001	CI522-MODTCP	92
1SAP150000R0261	PM590-ARCNET	84	1SAP182700R0001	TA541	144	1SAP224100R0001	CI541-DP	92
1SAP150000R0271	PM590-ETH	84	1SAP182800R0001	TA543	96	1SAP224200R0001	CI542-DP	92
1SAP150000R0379	PM590-MC-KIT	84	1SAP182800R0001	TA543	144	1SAP228100R0001	CI581-CN	92
1SAP150000R0379	PM590-MC-KIT	221	1SAP182900R0001	TA514-SAFETY	178	1SAP228200R0001	CI582-CN	92
1SAP150100R0271	PM591-ETH	84	1SAP182900R0001	TA514-SAFETY	233	1SAP230500R0000	DI572	67
1SAP150100R0277	PM591-2ETH	84	1SAP183100R0001	TA536	96	1SAP230900R0000	DO562	67
1SAP150200R0271	PM592-ETH	84	1SAP183100R0001	TA536	144	1SAP231300R0000	DO573	67
1SAP151000R0278	PM5670-2ETH	88	1SAP186100R0001	TK506	68	1SAP231900R0000	DC562	67
1SAP151500R0278	PM5675-2ETH	88	1SAP186200R0004	TA574-D-T-ETH	234	1SAP233100R0001	FM562	68
1SAP155500R0279	PM595-4ETH-F	85	1SAP186400R0001	TA569-RS-ISO	68	1SAP240000R0001	DI524	90
1SAP155500R0279	PM595-4ETH-F	221	1SAP187700R0001	TA5450-CASE	96	1SAP240100R0001	DC532	90
1SAP170400R0201	CM574-RS	90	1SAP187700R0001	TA5450-CASE	233	1SAP240500R0001	DC523	90
1SAP170401R0201	CM574-RCOM	90	1SAP192100R0102	PS552-MC-E	53	1SAP240600R0001	DC522	90
1SAP170901R0101	CM579-PNIO	90	1SAP193600R0001	DM-KEY	52	1SAP240700R0001	DO524	90
1SAP170902R0101	CM579-ETHCAT	90	1SAP195000R0101	PS562-SOLAR	53	1SAP240800R0001	DO526	90
1SAP172200R0001	CM582-DP	90	1SAP195400R0101	PS5601-HA-MTCP	53	1SAP245000R0001	DX531	90
1SAP172800R0001	CM588-CN	90	1SAP195400R0101	PS5601-HA-MTCP	88	1SAP245200R0001	DX522	90
1SAP172900R0011	CM589-PNIO	90	1SAP195400R0101	PS5601-HA-MTCP	137	1SAP250000R0001	AX522	91
1SAP172900R0111	CM589-PNIO-4	90	1SAP195500R0101	PS565-BACnet-ASC	53	1SAP250100R0001	AX521	91
1SAP173200R0001	CM592-DP	90	1SAP195550R0101	PS5607-BACnet-BC	53	1SAP250200R0001	AO523	91
1SAP173700R0001	CM597-ETH	90	1SAP195550R0101	PS5607-BACnet-BC	88	1SAP250300R0001	AI523	91
1SAP173800R0001	CM598-CN	90	1SAP195550R0101	PS5607-BACnet-BC	137	1SAP250500R0001	AC522	91
1SAP180100R0001	MC502	68	1SAP195600R0101	PS5602-61850	53	1SAP250600R0001	AI531	91

Index

Order code classification

Order code	Type	Page
1SAP250700R0001	DA501	91
1SAP250800R0001	DA502	91
1SAP260100R0001	PD501-4CH	91
1SAP260300R0001	CD522	91
1SAP260400R0001	FM502-CMS	87
1SAP270000R0001	DC541-CM	91
1SAP280000R0001	SM560-S	178
1SAP281200R0001	TU582-S	178
1SAP282000R0001	AI581-S	178
1SAP284000R0001	DI581-S	178
1SAP284100R0001	DX581-S	178
1SAP286000R0001	SM560-S-FD-1	178
1SAP286100R0001	SM560-S-FD-4	178
1SAP310300R0278	TB5600-2ETH-XC	138
1SAP311100R0270	TB511-ETH-XC	135
1SAP311300R0278	TB5610-2ETH-XC	138
1SAP312100R0270	TB521-ETH-XC	135
1SAP312300R0278	TB5620-2ETH-XC	138
1SAP314100R0270	TB541-ETH-XC	135
1SAP314300R0278	TB5640-2ETH-XC	138
1SAP316300R0278	TB5660-2ETH-XC	138
1SAP317000R0271	TF501-CMS-XC	136
1SAP317200R0271	TF521-CMS-XC	136
1SAP330300R0271	PM573-ETH-XC	134
1SAP331000R0278	PM5630-2ETH-XC	137
1SAP340200R0201	PM582-XC	134
1SAP340300R0271	PM583-ETH-XC	134
1SAP341000R0278	PM5650-2ETH-XC	137
1SAP350100R0271	PM591-ETH-XC	134
1SAP350200R0271	PM592-ETH-XC	134
1SAP351000R0278	PM5670-2ETH-XC	137
1SAP351500R0278	PM5675-2ETH-XC	137
1SAP351500R0279	PM595-4ETH-M-XC	134
1SAP370901R0101	CM579-PNIO-XC	139
1SAP372200R0001	CM582-DP-XC	139
1SAP372800R0001	CM588-CN-XC	139
1SAP372900R0011	CM589-PNIO-XC	139
1SAP372900R0111	CM589-PNIO-4-XC	139
1SAP373200R0001	CM592-DP-XC	139
1SAP373700R0001	CM597-ETH-XC	139
1SAP373800R0001	CM598-CN-XC	139
1SAP380000R0001	SM560-S-XC	179
1SAP386000R0001	SM560-S-FD-1-XC	179
1SAP386100R0001	SM560-S-FD-4-XC	179
1SAP410400R0001	TU552-CS31-XC	142
1SAP410800R0001	TU510-XC	142
1SAP411200R0001	TU518-XC	142
1SAP412000R0001	TU516-XC	142
1SAP413200R0001	TU542-XC	142
1SAP414000R0001	TU508-ETH-XC	142
1SAP414400R0001	TU520-ETH-XC	142
1SAP415000R0001	TU516-H-XC	142
1SAP415100R0001	TU532-H-XC	142
1SAP415200R0001	TU542-H-XC	142
1SAP417000R0001	TU532-XC	142
1SAP420500R0001	DC551-CS31-XC	141
1SAP420600R0001	CI501-PNIO-XC	141

Order code	Type	Page
1SAP420700R0001	CI502-PNIO-XC	141
1SAP421100R0001	CI590-CS31-HA-XC	141
1SAP421200R0001	CI592-CS31-XC	141
1SAP421300R0001	CI504-PNIO-XC	141
1SAP421500R0001	CI506-PNIO-XC	141
1SAP422100R0001	CI521-MODTCP-XC	141
1SAP422200R0001	CI522-MODTCP-XC	141
1SAP424100R0001	CI541-DP-XC	141
1SAP424200R0001	CI542-DP-XC	141
1SAP428100R0001	CI581-CN-XC	141
1SAP428200R0001	CI582-CN-XC	141
1SAP440000R0001	DI524-XC	139
1SAP440100R0001	DC532-XC	139
1SAP440500R0001	DC523-XC	139
1SAP440600R0001	DC522-XC	139
1SAP440700R0001	DO524-XC	139
1SAP440800R0001	DO526-XC	139
1SAP445200R0001	DX522-XC	139
1SAP450000R0001	AX522-XC	140
1SAP450100R0001	AX521-XC	140
1SAP450200R0001	AO523-XC	140
1SAP450300R0001	AI523-XC	140
1SAP450600R0001	AI531-XC	140
1SAP450700R0001	DA501-XC	140
1SAP450800R0001	DA502-XC	140
1SAP460300R0001	CD522-XC	140
1SAP460400R0001	FM502-CMS-XC	136
1SAP470000R0001	DC541-CM-XC	140
1SAP481200R0001	TU582-S-XC	179
1SAP482000R0001	AI581-S-XC	179
1SAP484000R0001	DI581-S-XC	179
1SAP484100R0001	DX581-S-XC	179
1SAP500900R0101	PB610	194
1SAP500901R0101	PB610-R	194
1SAP500981R0001	TK681	194
1SAP500982R0001	TK682	194
1SAP504100R0001	CP604	192
1SAP504100R2001	CP604-B	192
1SAP507100R0001	CP607	192
1SAP507100R2001	CP607-B	192
1SAP510100R0001	CP610	192
1SAP510100R2001	CP610-B	192
1SAP520100R0001	CP620	193
1SAP520200R0001	CP620-WEB	193
1SAP530100R0001	CP630	193
1SAP530200R0001	CP630-WEB	193
1SAP535100R0001	CP635	193
1SAP535100R2001	CP635-B	193
1SAP535110R1001	CP635-FW	194
1SAP535110R6001	CP635-FB	194
1SAP535200R0001	CP635-WEB	193
1SAP540710R0001	CP6407	192
1SAP541010R0001	CP6410	192
1SAP541510R0001	CP6415	192
1SAP551100R0001	CP651	193
1SAP551200R0001	CP651-WEB	193
1SAP560510R0001	CP6605	193

Order code	Type	Page
1SAP560710R0001	CP6607	193
1SAP561010R0001	CP6610	193
1SAP561100R0001	CP661	193
1SAP561200R0001	CP661-WEB	193
1SAP561510R0001	CP6615	193
1SAP562110R0001	CP6621	193
1SAP565100R0001	CP665	193
1SAP565200R0001	CP665-WEB	193
1SAP576100R0001	CP676	193
1SAP576200R0001	CP676-WEB	193
1SAS010000R0102	DM200-TOOL	52
1SAS010001R0102	DM201-TOOL-UPGR	52
1SAS010002R0102	DM202-PREM	52
1SAS010003R0102	DM203-PREM-UPGR	52
1SAS010004R0102	DM204-TOOL-NW	52
1SAS010007R0102	DM207-PVC	52
1SAS010010R0102	DM210-PSA	52
1SAS010011R0102	DM211-PPR	52
1SAS010014R0102	DM214-PVC-NW	52
1SAS010017R0102	DM217-PSA-NW	52
1SAS010018R0102	DM218-PPR-NW	52
1SAS010020R0102	DM220-FSE	52
1SAS010021R0102	DM221-FSE-NW	52
1SAS010050R0102	DM250-VCP	52
1SAS010051R0102	DM251-VCP-NW	52
1SAS030000R0101	PS563-WATER	53
1SAS030010R0101	PS564-TEMPCTRL	53
1TNE968901R0100	MC503	68
1TNE968901R1100	TK503	68
1TNE968901R2100	TK504	68
1TNE968901R3101	TA563-9	69
1TNE968901R3102	TA563-11	69
1TNE968901R3103	TA564-9	69
1TNE968901R3104	TA564-11	69
1TNE968901R3105	TA565-9	69
1TNE968901R3106	TA565-11	69
1TNE968901R3107	TA566	68
1TNE968901R3203	TA570	68
1TNE968901R4300	TA562-RS	68
1TNE968902R1101	AI561	67
1TNE968902R1102	AI562	67
1TNE968902R1103	AI563	67
1TNE968902R1201	AO561	67
1TNE968902R1301	AX561	67
1TNE968902R2101	DI561	67
1TNE968902R2102	DI562	67
1TNE968902R2103	DI571	67
1TNE968902R2201	DO561	67
1TNE968902R2202	DO571	67
1TNE968902R2203	DO572	67
1TNE968902R2301	DX561	67
1TNE968902R2302	DX571	67
1TNE968903R0203	TA571-SIM	68

Index

Type classification

Type	Order code	Page
AC522	1SAP250500R0001	91
AI523	1SAP250300R0001	91
AI523-XC	1SAP450300R0001	140
AI531	1SAP250600R0001	91
AI531-XC	1SAP450600R0001	140
AI561	1TNE968902R1101	67
AI562	1TNE968902R1102	67
AI563	1TNE968902R1103	67
AI581-S	1SAP282000R0001	178
AI581-S-XC	1SAP482000R0001	179
AO523	1SAP250200R0001	91
AO523-XC	1SAP450200R0001	140
AO561	1TNE968902R1201	67
AX521	1SAP250100R0001	91
AX521-XC	1SAP450100R0001	140
AX522	1SAP250000R0001	91
AX522-XC	1SAP450000R0001	140
AX561	1TNE968902R1301	67
CD522	1SAP260300R0001	91
CD522-XC	1SAP460300R0001	140
CI501-PNIO	1SAP220600R0001	92
CI501-PNIO-XC	1SAP420600R0001	141
CI502-PNIO	1SAP220700R0001	92
CI502-PNIO-XC	1SAP420700R0001	141
CI504-PNIO	1SAP221300R0001	93
CI504-PNIO-XC	1SAP421300R0001	141
CI506-PNIO	1SAP221500R0001	93
CI506-PNIO-XC	1SAP421500R0001	141
CI511-ETHCAT	1SAP220900R0001	92
CI512-ETHCAT	1SAP221000R0001	92
CI521-MODTCP	1SAP222100R0001	92
CI521-MODTCP-XC	1SAP422100R0001	141
CI522-MODTCP	1SAP222200R0001	92
CI522-MODTCP-XC	1SAP422200R0001	141
CI541-DP	1SAP224100R0001	92
CI541-DP-XC	1SAP424100R0001	141
CI542-DP	1SAP224200R0001	92
CI542-DP-XC	1SAP424200R0001	141
CI581-CN	1SAP228100R0001	92
CI581-CN-XC	1SAP428100R0001	141
CI582-CN	1SAP228200R0001	92
CI582-CN-XC	1SAP428200R0001	141
CI590-CS31-HA	1SAP221100R0001	92
CI590-CS31-HA-XC	1SAP421100R0001	141
CI592-CS31	1SAP221200R0001	92
CI592-CS31-XC	1SAP421200R0001	141
CM574-RCOM	1SAP170401R0201	90
CM574-RS	1SAP170400R0201	90
CM579-ETHCAT	1SAP170902R0101	90
CM579-PNIO	1SAP170901R0101	90
CM579-PNIO-XC	1SAP370901R0101	139
CM582-DP	1SAP172200R0001	90
CM582-DP-XC	1SAP372200R0001	139
CM588-CN	1SAP172800R0001	90
CM588-CN-XC	1SAP372800R0001	139
CM589-PNIO	1SAP172900R0011	90
CM589-PNIO-4	1SAP172900R0111	90

Type	Order code	Page
CM589-PNIO-4-XC	1SAP372900R0111	139
CM589-PNIO-XC	1SAP372900R0011	139
CM592-DP	1SAP173200R0001	90
CM592-DP-XC	1SAP373200R0001	139
CM597-ETH	1SAP173700R0001	90
CM597-ETH-XC	1SAP373700R0001	139
CM598-CN	1SAP173800R0001	90
CM598-CN-XC	1SAP373800R0001	139
CP604	1SAP504100R0001	192
CP604-B	1SAP504100R2001	192
CP607	1SAP507100R0001	192
CP607-B	1SAP507100R2001	192
CP610	1SAP510100R0001	192
CP610-B	1SAP510100R2001	192
CP620	1SAP520100R0001	193
CP620-WEB	1SAP520200R0001	193
CP630	1SAP530100R0001	193
CP630-WEB	1SAP530200R0001	193
CP635	1SAP535100R0001	193
CP635-B	1SAP535100R2001	193
CP635-FB	1SAP535110R6001	194
CP635-FW	1SAP535110R1001	194
CP635-WEB	1SAP535200R0001	193
CP6407	1SAP540710R0001	192
CP6410	1SAP541010R0001	192
CP6415	1SAP541510R0001	192
CP651	1SAP551100R0001	193
CP651-WEB	1SAP551200R0001	193
CP6605	1SAP560510R0001	193
CP6607	1SAP560710R0001	193
CP661	1SAP561100R0001	193
CP6610	1SAP561010R0001	193
CP6615	1SAP561510R0001	193
CP661-WEB	1SAP561200R0001	193
CP6621	1SAP562110R0001	193
CP665	1SAP565100R0001	193
CP665-WEB	1SAP565200R0001	193
CP676	1SAP576100R0001	193
CP676-WEB	1SAP576200R0001	193
DA501	1SAP250700R0001	91
DA501-XC	1SAP450700R0001	140
DA502	1SAP250800R0001	91
DA502-XC	1SAP450800R0001	140
DC522	1SAP240600R0001	90
DC522-XC	1SAP440600R0001	139
DC523	1SAP240500R0001	90
DC523-XC	1SAP440500R0001	139
DC532	1SAP240100R0001	90
DC532-XC	1SAP440100R0001	139
DC541-CM	1SAP270000R0001	91
DC541-CM-XC	1SAP470000R0001	140
DC551-CS31	1SAP220500R0001	92
DC551-CS31-XC	1SAP420500R0001	141
DC562	1SAP231900R0000	67
DI524	1SAP240000R0001	90
DI524-XC	1SAP440000R0001	139
DI561	1TNE968902R2101	67

Type	Order code	Page
DI562	1TNE968902R2102	67
DI571	1TNE968902R2103	67
DI572	1SAP230500R0000	67
DI581-S	1SAP284000R0001	178
DI581-S-XC	1SAP484000R0001	179
DM200-TOOL	1SAS010000R0102	52
DM201-TOOL-UPGR	1SAS010001R0102	52
DM202-PREM	1SAS010002R0102	52
DM203-PREM-UPGR	1SAS010003R0102	52
DM204-TOOL-NW	1SAS010004R0102	52
DM207-PVC	1SAS010007R0102	52
DM210-PSA	1SAS010010R0102	52
DM211-PPR	1SAS010011R0102	52
DM214-PVC-NW	1SAS010014R0102	52
DM217-PSA-NW	1SAS010017R0102	52
DM218-PPR-NW	1SAS010018R0102	52
DM220-FSE	1SAS010020R0102	52
DM221-FSE-NW	1SAS010021R0102	52
DM250-VCP	1SAS010050R0102	52
DM251-VCP-NW	1SAS010051R0102	52
DM-KEY	1SAP193600R0001	52
DO524	1SAP240700R0001	90
DO524-XC	1SAP440700R0001	139
DO526	1SAP240800R0001	90
DO526-XC	1SAP440800R0001	139
DO561	1TNE968902R2201	67
DO562	1SAP230900R0000	67
DO571	1TNE968902R2202	67
DO572	1TNE968902R2203	67
DO573	1SAP231300R0000	67
DX522	1SAP245200R0001	90
DX522-XC	1SAP445200R0001	139
DX531	1SAP245000R0001	90
DX561	1TNE968902R2301	67
DX571	1TNE968902R2302	67
DX581-S	1SAP284100R0001	178
DX581-S-XC	1SAP484100R0001	179
FM502-CMS	1SAP260400R0001	87
FM502-CMS-XC	1SAP460400R0001	136
FM562	1SAP233100R0001	68
MC502	1SAP180100R0001	68
MC502	1SAP180100R0001	96
MC502	1SAP180100R0001	144
MC503	1TNE968901R0100	68
PB610	1SAP500900R0101	194
PB610-R	1SAP500901R0101	194
PD501-4CH	1SAP260100R0001	91
PM554-RP	1SAP120700R0001	66
PM554-RP-AC	1SAP120800R0001	66
PM554-TP	1SAP120600R0001	66
PM554-TP-ETH	1SAP120600R0071	66
PM556-TP-ETH	1SAP121200R0071	66
PM5630-2ETH	1SAP131000R0278	88
PM5630-2ETH-XC	1SAP331000R0278	137
PM564-RP	1SAP121000R0001	66
PM564-RP-AC	1SAP121100R0001	66
PM564-RP-ETH	1SAP121000R0071	66

Index

Type classification

Type	Order code	Page
PM564-RP-ETH-AC	1SAP121100R0071	66
PM564-TP	1SAP120900R0001	66
PM564-TP-ETH	1SAP120900R0071	66
PM5650-2ETH	1SAP141000R0278	88
PM5650-2ETH-XC	1SAP341000R0278	137
PM566-TP-ETH	1SAP121500R0071	66
PM5670-2ETH	1SAP151000R0278	88
PM5670-2ETH-XC	1SAP351000R0278	137
PM5675-2ETH	1SAP151500R0278	88
PM5675-2ETH-XC	1SAP351500R0278	137
PM572	1SAP130200R0200	84
PM573-ETH	1SAP130300R0271	84
PM573-ETH-XC	1SAP330300R0271	134
PM582	1SAP140200R0201	84
PM582-XC	1SAP340200R0201	134
PM583-ETH	1SAP140300R0271	84
PM583-ETH-XC	1SAP340300R0271	134
PM585-ETH	1SAP140500R0271	84
PM585-MC-KIT	1SAP140500R0379	84
PM585-MC-KIT	1SAP140500R0379	221
PM590-ARCNET	1SAP150000R0261	84
PM590-ETH	1SAP150000R0271	84
PM590-MC-KIT	1SAP150000R0379	84
PM590-MC-KIT	1SAP150000R0379	221
PM591-2ETH	1SAP150100R0277	84
PM591-ETH	1SAP150100R0271	84
PM591-ETH-XC	1SAP350100R0271	134
PM592-ETH	1SAP150200R0271	84
PM592-ETH-XC	1SAP350200R0271	134
PM595-4ETH-F	1SAP155500R0279	85
PM595-4ETH-F	1SAP155500R0279	221
PM595-4ETH-M-XC	1SAP351500R0279	134
PS552-MC-E	1SAP192100R0102	53
PS5601-HA-MTCP	1SAP195400R0101	53
PS5601-HA-MTCP	1SAP195400R0101	88
PS5601-HA-MTCP	1SAP195400R0101	137
PS5602-61850	1SAP195600R0101	53
PS5602-61850	1SAP195600R0101	88
PS5602-61850	1SAP195600R0101	137
PS5604-KNX	1SAP195800R0101	53
PS5604-KNX	1SAP195800R0101	88
PS5604-KNX	1SAP195800R0101	137
PS5607-BACnet-BC	1SAP195550R0101	53
PS5607-BACnet-BC	1SAP195550R0101	88
PS5607-BACnet-BC	1SAP195550R0101	137
PS562-SOLAR	1SAP195000R0101	53
PS563-WATER	1SAS030000R0101	53
PS564-TEMPCTRL	1SAS030010R0101	53
PS565-BACnet-ASC	1SAP195500R0101	53
SM560-S	1SAP280000R0001	178
SM560-S-FD-1	1SAP286000R0001	178
SM560-S-FD-1-XC	1SAP386000R0001	179
SM560-S-FD-4	1SAP286100R0001	178
SM560-S-FD-4-XC	1SAP386100R0001	179
SM560-S-XC	1SAP380000R0001	179
TA514-SAFETY	1SAP182900R0001	178
TA514-SAFETY	1SAP182900R0001	233

Type	Order code	Page
TA515-CASE	1SAP182400R0002	96
TA515-CASE	1SAP182400R0002	233
TA521	1SAP180300R0001	96
TA521	1SAP180300R0001	144
TA523	1SAP180500R0001	96
TA523	1SAP180500R0001	144
TA524	1SAP180600R0001	96
TA524	1SAP180600R0001	144
TA525	1SAP180700R0001	96
TA525	1SAP180700R0001	144
TA526	1SAP180800R0001	96
TA526	1SAP180800R0001	144
TA527	1SAP181100R0001	96
TA527	1SAP181100R0001	144
TA528	1SAP181200R0001	96
TA528	1SAP181200R0001	144
TA532	1SAP182000R0001	96
TA532	1SAP182000R0001	144
TA533	1SAP182100R0001	96
TA533	1SAP182100R0001	144
TA534	1SAP182200R0001	96
TA534	1SAP182200R0001	144
TA535	1SAP182300R0001	144
TA536	1SAP183100R0001	96
TA536	1SAP183100R0001	144
TA540	1SAP182600R0001	96
TA540	1SAP182600R0001	144
TA541	1SAP182700R0001	96
TA541	1SAP182700R0001	144
TA543	1SAP182800R0001	96
TA543	1SAP182800R0001	144
TA5450-CASE	1SAP187700R0001	96
TA5450-CASE	1SAP187700R0001	233
TA561-RTC	1SAP181400R0001	68
TA562-RS	1TNE968901R4300	68
TA562-RS-RTC	1SAP181500R0001	68
TA563-11	1TNE968901R3102	69
TA563-9	1TNE968901R3101	69
TA564-11	1TNE968901R3104	69
TA564-9	1TNE968901R3103	69
TA565-11	1TNE968901R3106	69
TA565-9	1TNE968901R3105	69
TA566	1TNE968901R3107	68
TA569-RS-ISO	1SAP186400R0001	68
TA570	1TNE968901R3203	68
TA571-SIM	1TNE968903R0203	68
TA574-D-T-ETH	1SAP186200R0004	234
TB511-ARCNET	1SAP111100R0260	86
TB511-ETH	1SAP111100R0270	86
TB511-ETH-XC	1SAP311100R0270	135
TB521-ARCNET	1SAP112100R0260	86
TB521-ETH	1SAP112100R0270	86
TB521-ETH-XC	1SAP312100R0270	135
TB523-2ETH	1SAP112300R0277	86
TB541-ETH	1SAP114100R0270	86
TB541-ETH-XC	1SAP314100R0270	135
TB5600-2ETH	1SAP110300R0278	89

Type	Order code	Page
TB5600-2ETH-XC	1SAP310300R0278	138
TB5610-2ETH	1SAP111300R0278	89
TB5610-2ETH-XC	1SAP311300R0278	138
TB5620-2ETH	1SAP112300R0278	89
TB5620-2ETH-XC	1SAP312300R0278	138
TB5640-2ETH	1SAP114300R0278	89
TB5640-2ETH-XC	1SAP314300R0278	138
TB5660-2ETH	1SAP116300R0278	89
TB5660-2ETH-XC	1SAP316300R0278	138
TF501-CMS	1SAP117000R0271	87
TF501-CMS-XC	1SAP317000R0271	136
TF521-CMS	1SAP117200R0271	87
TF521-CMS-XC	1SAP317200R0271	136
TK501	1SAP180200R0001	96
TK501	1SAP180200R0001	144
TK502	1SAP180200R0101	96
TK502	1SAP180200R0101	144
TK503	1TNE968901R1100	68
TK504	1TNE968901R2100	68
TK506	1SAP186100R0001	68
TK681	1SAP500981R0001	194
TK682	1SAP500982R0001	194
TU507-ETH	1SAP214200R0001	94
TU508-ETH	1SAP214000R0001	94
TU508-ETH-XC	1SAP414000R0001	142
TU509	1SAP211000R0001	94
TU510	1SAP210800R0001	94
TU510-XC	1SAP410800R0001	142
TU515	1SAP212200R0001	94
TU516	1SAP212000R0001	94
TU516-H	1SAP215000R0001	93
TU516-H-XC	1SAP415000R0001	142
TU516-XC	1SAP412000R0001	142
TU517	1SAP211400R0001	94
TU518	1SAP211200R0001	94
TU518-XC	1SAP411200R0001	142
TU520-ETH	1SAP214400R0001	94
TU520-ETH-XC	1SAP414400R0001	142
TU531	1SAP217200R0001	94
TU532	1SAP217000R0001	94
TU532-H	1SAP215100R0001	93
TU532-H-XC	1SAP415100R0001	142
TU532-XC	1SAP417000R0001	142
TU541	1SAP213000R0001	94
TU542	1SAP213200R0001	94
TU542-H	1SAP215200R0001	93
TU542-H-XC	1SAP415200R0001	142
TU542-XC	1SAP413200R0001	142
TU551-CS31	1SAP210600R0001	94
TU552-CS31	1SAP210400R0001	94
TU552-CS31-XC	1SAP410400R0001	142
TU582-S	1SAP281200R0001	178
TU582-S-XC	1SAP481200R0001	179

Additional information

We reserve the right to make technical changes or modify the contents of this document without prior notice. ABB does not accept any responsibility whatsoever for potential errors or possible lack of information in this document.

We reserve all rights in this document and in the subject matter and illustrations contained therein. Any reproduction, disclosure to third parties or utilization of its contents – in whole or in parts – is forbidden without prior written consent of ABB.



ABB Automation Products GmbH

Eppelheimer Straße 82
D-69123 Heidelberg / Germany
Tel.: +49 62 21 701 1444
Fax: +49 62 21 701 1382



www.abb.com/plc



www.abb.com/automationbuilder